

Project Specific Water Quality Management Plan

A Template for Projects located within the **Santa Ana Watershed** Region of Riverside County

Project Title: Old 215 Frontage Road

Development No: PEN21-0325

Design Review/Case No: LWQ22-0008

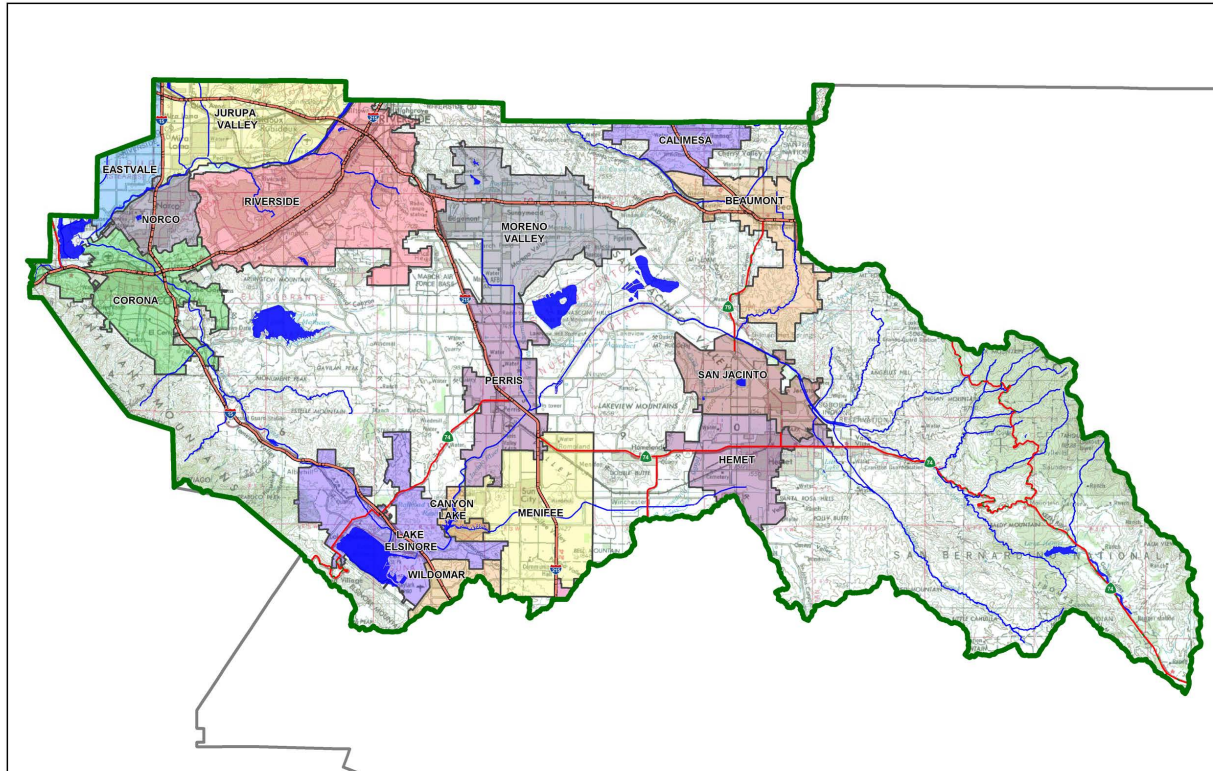

- Preliminary
- Final

Original Date Prepared: December 9, 2021

Revision Date(s): March 18, 2022

Prepared for Compliance with

*Regional Board Order No. **R8-2010-0033***

Template revised June 30, 2016

Contact Information:

Prepared for:

Mark Bachli
CDRE Holdings 18, LLC
523 Main Street
El Segundo, CA 90245
(310) 428-3302

Prepared by:

CASC Engineering and Consulting
1470 E. Cooley Drive
Colton, CA 92324
(909) 783-0101, Csidor@cascinc.com
Attn: Chris Sidor, PE

A Brief Introduction

This Project-Specific WQMP Template for the **Santa Ana Region** has been prepared to help guide you in documenting compliance for your project. Because this document has been designed to specifically document compliance, you will need to utilize the WQMP Guidance Document as your “how-to” manual to help guide you through this process. Both the Template and Guidance Document go hand-in-hand, and will help facilitate a well prepared Project-Specific WQMP. Below is a flowchart for the layout of this Template that will provide the steps required to document compliance.

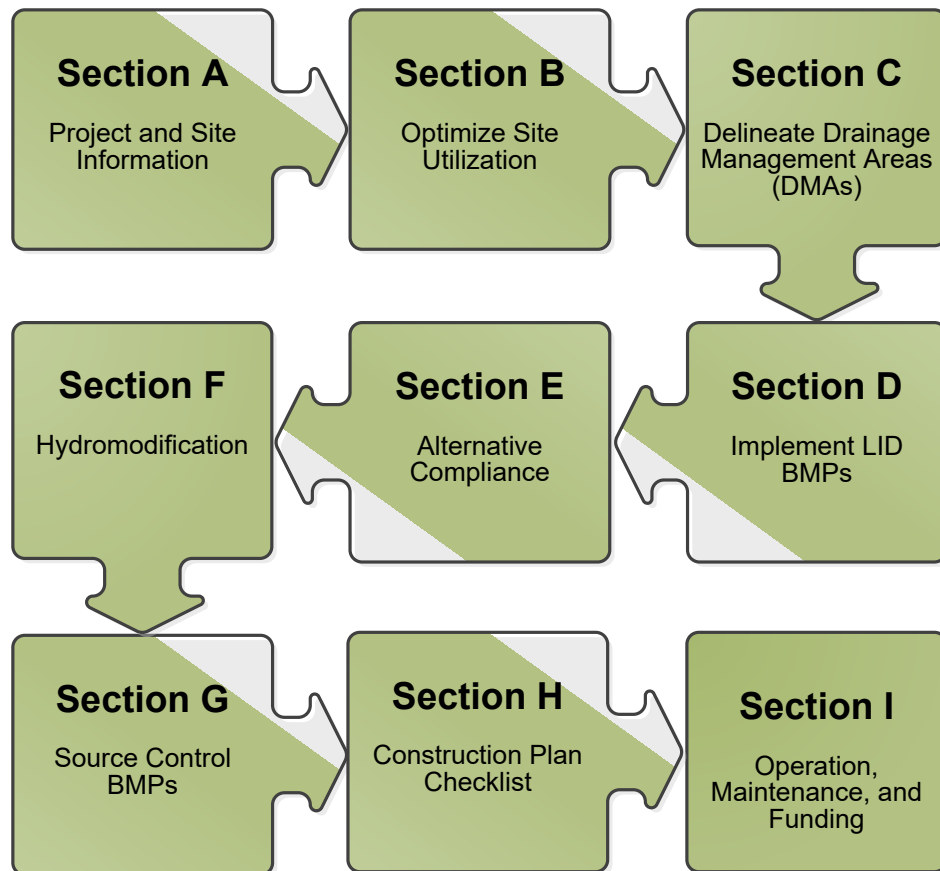

OWNER'S CERTIFICATION

This Project-Specific Water Quality Management Plan (WQMP) has been prepared for Mark Bachli by CASC Engineering and Consulting for the Old 215 Frontage/Edgemont Street Industrial Buildings project.

This WQMP is intended to comply with the requirements of Moreno Valley for Ordinance No. 827 which includes the requirement for the preparation and implementation of a Project-Specific WQMP.

The undersigned, while owning the property/project described in the preceding paragraph, shall be responsible for the implementation and funding of this WQMP and will ensure that this WQMP is amended as appropriate to reflect up-to-date conditions on the site. In addition, the property owner accepts responsibility for interim operation and maintenance of Stormwater BMPs until such time as this responsibility is formally transferred to a subsequent owner. This WQMP will be reviewed with the facility operator, facility supervisors, employees, tenants, maintenance and service contractors, or any other party (or parties) having responsibility for implementing portions of this WQMP. At least one copy of this WQMP will be maintained at the project site or project office in perpetuity. The undersigned is authorized to certify and to approve implementation of this WQMP. The undersigned is aware that implementation of this WQMP is enforceable under Moreno Valley Water Quality Ordinance (Municipal Code Section 8.10).

"I, the undersigned, certify under penalty of law that the provisions of this WQMP have been reviewed and accepted and that the WQMP will be transferred to future successors in interest."

Owner's Signature

Date

Mark Bachli
Owner's Printed Name

Owner's Title/Position

PREPARER'S CERTIFICATION

"The selection, sizing and design of stormwater treatment and other stormwater quality and quantity control measures in this plan meet the requirements of Regional Water Quality Control Board Order No. **R8-2010-0033** and any subsequent amendments thereto."

Preparer's Signature

Date

Chris Sidor, PE
Preparer's Printed Name

Project Engineer
Preparer's Title/Position

Preparer's Licensure: C90500

Table of Contents

Section A: Project and Site Information.....	6
A.1 Maps and Site Plans.....	6
A.2 Identify Receiving Waters.....	8
A.3 Additional Permits/Approvals required for the Project:	8
Section B: Optimize Site Utilization (LID Principles)	9
Section C: Delineate Drainage Management Areas (DMAs).....	11
Section D: Implement LID BMPs	13
D.1 Infiltration Applicability	13
D.2 Harvest and Use Assessment.....	14
D.3 Bioretention and Biotreatment Assessment	16
D.4 Feasibility Assessment Summaries	17
D.5 LID BMP Sizing	18
Section E: Alternative Compliance (LID Waiver Program)	21
E.1 Identify Pollutants of Concern	22
E.2 Stormwater Credits	23
E.3 Sizing Criteria.....	23
E.4 Treatment Control BMP Selection	24
Section F: Hydromodification	25
F.1 Hydrologic Conditions of Concern (HCOC) Analysis.....	25
F.2 HCOC Mitigation.....	26
Section G: Source Control BMPs.....	27
Section H: Construction Plan Checklist	30
Section I: Operation, Maintenance and Funding.....	31

List of Tables

Table A.1 Identification of Receiving Waters.....	8
Table A.2 Other Applicable Permits.....	8
Table C.1 DMA Classifications.....	11
Table C.2 Type 'A', Self-Treating Areas.....	11
Table C.3 Type 'B', Self-Retaining Areas.....	11
Table C.4 Type 'C', Areas that Drain to Self-Retaining Areas.....	12
Table C.5 Type 'D', Areas Draining to BMPs.....	12
Table D.1 Infiltration Feasibility.....	13
Table D.2 LID Prioritization Summary Matrix.....	17
Table D.3 DCV Calculations for LID BMPs.....	18
Table E.1 Potential Pollutants by Land Use Type.....	22
Table E.2 Water Quality Credits.....	23
Table E.3 Treatment Control BMP Sizing.....	23
Table E.4 Treatment Control BMP Selection.....	24
Table F.1 Hydrologic Conditions of Concern Summary.....	25
Table G.1 Permanent and Operational Source Control Measures.....	27
Table H.1 Construction Plan Cross-reference.....	30

List of Appendices

Appendix 1: Maps and Site Plans.....	32
Appendix 2: Construction Plans.....	33
Appendix 3: Soils Information.....	34
Appendix 4: Historical Site Conditions.....	35
Appendix 5: LID Infeasibility.....	36
Appendix 6: BMP Design Details.....	37
Appendix 7: Hydromodification.....	38
Appendix 8: Source Control.....	39
Appendix 9: O&M.....	40
Appendix 10: Educational Materials.....	- 6 -

Section A: Project and Site Information

PROJECT INFORMATION	
Type of Project:	Industrial
Planning Area:	Northwest Riverside County
Community Name:	Old 215
Development Name:	Old 215 Frontage Road Industrial Building
PROJECT LOCATION	
Latitude & Longitude (DMS): 33°55'21.8100"N, 117°17'04.2100" W	
Project Watershed and Sub-Watershed: Santa Ana	
Gross Acres: 8.20 Acres	
APN(s): 263-190-012, -014, -015, -016, -017, -018, -019, -036	
Map Book and Page No.: MB 12/19	
PROJECT CHARACTERISTICS	
Proposed or Potential Land Use(s)	Industrial
Proposed or Potential SIC Code(s)	1541
Area of Impervious Project Footprint (SF)	357,305 SF
Total Area of <u>proposed</u> Impervious Surfaces within the Project Footprint (SF)/or Replacement	315,627 SF
Does the project consist of offsite road improvements?	<input checked="" type="checkbox"/> Y <input type="checkbox"/> N
Does the project propose to construct unpaved roads?	<input type="checkbox"/> Y <input checked="" type="checkbox"/> N
Is the project part of a larger common plan of development (phased project)?	<input type="checkbox"/> Y <input checked="" type="checkbox"/> N
EXISTING SITE CHARACTERISTICS	
Total area of <u>existing</u> Impervious Surfaces within the Project limits Footprint (SF)	0
Is the project located within any MSHCP Criteria Cell?	<input type="checkbox"/> Y <input checked="" type="checkbox"/> N
If so, identify the Cell number:	N/A
Are there any natural hydrologic features on the project site?	<input type="checkbox"/> Y <input checked="" type="checkbox"/> N
Is a Geotechnical Report attached?	<input checked="" type="checkbox"/> Y <input type="checkbox"/> N
If no Geotech. Report, list the NRCS soils type(s) present on the site (A, B, C and/or D)	N/A
What is the Water Quality Design Storm Depth for the project?	0.62"

A.1 Maps and Site Plans

When completing your Project-Specific WQMP, include a map of the local vicinity and existing site. In addition, include all grading, drainage, landscape/plant palette and other pertinent construction plans in Appendix 2. At a **minimum**, your WQMP Site Plan should include the following:

- Drainage Management Areas
- Proposed Structural BMPs
- Drainage Path
- Drainage Infrastructure, Inlets, Overflows
- Source Control BMPs
- Buildings, Roof Lines, Downspouts
- Impervious Surfaces
- Standard Labeling
- BMP Locations (Lat/Long)

Use your discretion on whether or not you may need to create multiple sheets or can appropriately accommodate these features on one or two sheets. Keep in mind that the Co-Permittee plan reviewer must be able to easily analyze your project utilizing this template and its associated site plans and maps.

Project Description:

The Old 215 Industrial Building project is located in the City of Moreno Valley, County of Riverside, California. The site is bounded by single family residences and vacant land to the north, Edgemont Street to the east, a single family residence and vacant land to the south, and Old 215 Frontage Road to the west. The existing boundary area is approximately 6.88 acres in size. Proposed street vacations from Old 215 and Edgemont Street will bring the total net project area to approximately 7.07 acres. Topographically, site elevations range from approximately 1540.00 feet to 1526.00 feet above Mean Sea Level (MSL). The project site generally drains from the south to the north to Edgemont Channel at an approximate grade of 1.20%.

The existing project site is currently vacant and undeveloped. The project proposes to construct two 50,000 square foot industrial warehouse buildings, associated parking, hardscape, landscape, and access points. The project will add approximately 315,000 square feet of impervious area on-site. The project will also consist of off-site street improvements along the old 215 Frontage Road and Edgemont Street.

The proposed design consists of one on-site Drainage Area (DA) that encompasses the entire project. Area A5 will drain via sheet flow, proposed ribbon gutter, and/or curb and gutter to a proposed drop inlet located on the east end of the site. Flows captured by the drop inlet will be directed via proposed storm drain to proposed underground detention chambers located beneath the proposed parking lot. The chambers will dewater via proposed storm drain located on the east side of the project that will connect to a proposed sump and pump. The sump and pump will pump flows to a proposed modular wetland device for water quality purposes. After flows have been directed through the proposed modular wetlands system, the treated flows will be directed to a public storm drain line running through the project site. The public storm drain is proposed as part of this project.

The proposed off-site street improvements will consist of off-site paving and contain four DAs. Upon development, runoff from Edgemont Street (DA 3 & DA 4) will enter of series of proposed under sidewalk drains that will direct flows to two bioswales located on the eastern side of the property. Treated flows will enter an underdrain, which will direct flows to a proposed catch basin, through the site, then into the Edgemont Channel. Similarly, runoff from the Old 215 Frontage Road (DA 1 & DA 2) will enter of series of proposed under sidewalk drains that will direct flows to two bioswales located on the western side of the property. Treated flows will enter an underdrain, which will direct flows to a proposed catch basin, through the site, then into the Edgemont Channel.

DAs 1-4 will be treated by BMPs 1-4, respectively, and DA 5 will be storage in underground detention chambers, then treated by a Modular Wetlands System. The bioswales will each consist of 3' of engineered soil media and underground perforated pipes. After flows have passed through the proposed Bioswales, the flows will be directed to the Edgemont Channel. Due to the comingling of off-site flows the Bioswales will treat runoff to the Maximum Extent Practicable (MEP).

The proposed project will be fully addressed by LID Principles, one Modular Wetlands System (MWS), and four Bioswales.

A.2 Identify Receiving Waters

Using Table A.1 below, list in order of upstream to downstream, the receiving waters that the project site is tributary to. Continue to fill each row with the Receiving Water's 303(d) listed impairments (if any), designated beneficial uses, and proximity, if any, to a RARE beneficial use. Include a map of the receiving waters in Appendix 1.

Table A.1 Identification of Receiving Waters

Receiving Waters	EPA Approved 303(d) List Impairments	Designated Beneficial Uses	Proximity to RARE Beneficial Use
Edgemont Channel	None	None	N/A
Sycamore Canyon Creek	None	None	N/A
Santa Ana River (Reach 3)	Copper, Lead, Pathogens	AGR, GWR, REC1, REC2, WARM, WILD, RARE, SPWN	8.8 Miles
Prado Basin Management Zone	pH	REC1, REC2, WARM, WILD, RARE	19.9 Miles
Santa Ana River (Reach 2)	None	AGR, GWR, REC1, REC2, WARM, WILD, RARE, SPWN	22.0 Miles
Santa Ana River (Reach 1)	None	REC1, REC2, WARM, WILD	N/A
Tidal Prism of Santa Ana River (to within 1000' of Victoria Street and Newport Slough)	None	REC1, REC2, COMM, WILD, RARE, MAR, EST	41.8 Miles

A.3 Additional Permits/Approvals required for the Project:

Table A.2 Other Applicable Permits

Agency	Permit Required	
State Department of Fish and Game, 1602 Streambed Alteration Agreement	<input type="checkbox"/> Y	<input checked="" type="checkbox"/> N
State Water Resources Control Board, Clean Water Act (CWA) Section 401 Water Quality Cert.	<input type="checkbox"/> Y	<input checked="" type="checkbox"/> N
US Army Corps of Engineers, CWA Section 404 Permit	<input type="checkbox"/> Y	<input checked="" type="checkbox"/> N
US Fish and Wildlife, Endangered Species Act Section 7 Biological Opinion	<input type="checkbox"/> Y	<input checked="" type="checkbox"/> N
Statewide Construction General Permit Coverage	<input checked="" type="checkbox"/> Y	<input type="checkbox"/> N
Statewide Industrial General Permit Coverage	<input type="checkbox"/> Y	<input checked="" type="checkbox"/> N
Western Riverside MSHCP Consistency Approval (e.g., JPR, DBESP)	<input type="checkbox"/> Y	<input checked="" type="checkbox"/> N
Other (please list in the space below as required) City of Moreno Valley Grading Permit	<input checked="" type="checkbox"/> Y	<input type="checkbox"/> N

If yes is answered to any of the questions above, the Co-Permittee may require proof of approval/coverage from those agencies as applicable including documentation of any associated requirements that may affect this Project-Specific WQMP.

Section B: Optimize Site Utilization (LID Principles)

Review of the information collected in Section 'A' will aid in identifying the principal constraints on site design and selection of LID BMPs as well as opportunities to reduce imperviousness and incorporate LID Principles into the site and landscape design. For example, **constraints** might include impermeable soils, high groundwater, groundwater pollution or contaminated soils, steep slopes, geotechnical instability, high-intensity land use, heavy pedestrian or vehicular traffic, utility locations or safety concerns. **Opportunities** might include existing natural areas, low areas, oddly configured or otherwise unbuildable parcels, easements and landscape amenities including open space and buffers (which can double as locations for bioretention BMPs), and differences in elevation (which can provide hydraulic head). Prepare a brief narrative for each of the site optimization strategies described below. This narrative will help you as you proceed with your LID design and explain your design decisions to others.

The 2010 Santa Ana MS4 Permit further requires that LID Retention BMPs (Infiltration Only or Harvest and Use) be used unless it can be shown that those BMPs are infeasible. Therefore, it is important that your narrative identify and justify if there are any constraints that would prevent the use of those categories of LID BMPs. Similarly, you should also note opportunities that exist which will be utilized during project design. Upon completion of identifying Constraints and Opportunities, include these on your WQMP Site plan in Appendix 1.

Consideration of "highest and best use" of the discharge should also be considered. For example, Lake Elsinore is evaporating faster than runoff from natural precipitation can recharge it. Requiring infiltration of 85% of runoff events for projects tributary to Lake Elsinore would only exacerbate current water quality problems associated with Pollutant concentration due to lake water evaporation. In cases where rainfall events have low potential to recharge Lake Elsinore (i.e. no hydraulic connection between groundwater to Lake Elsinore, or other factors), requiring infiltration of Urban Runoff from projects is counterproductive to the overall watershed goals. Project proponents, in these cases, would be allowed to discharge Urban Runoff, provided they used equally effective filtration-based BMPs.

Site Optimization

The following questions are based upon Section 3.2 of the WQMP Guidance Document. Review of the WQMP Guidance Document will help you determine how best to optimize your site and subsequently identify opportunities and/or constraints, and document compliance.

Did you identify and preserve existing drainage patterns? If so, how? If not, why?

No, the preexisting site conditions drained towards the north and into the Edgemont Channel. The planned grading will convey flows to the east and into a catch basin, which then directs flows northerly into the Edgemont channel via storm drain line.

Did you identify and protect existing vegetation? If so, how? If not, why?

No, the site currently contains little to no vegetation.

Did you identify and preserve natural infiltration capacity? If so, how? If not, why?

No, per the Geotechnical Report (Appendix 3) infiltration rates did not meet the BMP criteria, and therefore infiltration was determined to be infeasible. Per the BMP hierarchy in the Guidance Manual, and per a

letter from the geotechnical engineer, flow-through biotreatment BMPs were selected on-site, which bioswales with underdrains were selection for off-site flows.

Did you identify and minimize impervious area? If so, how? If not, why?

No, the project proposes a large building and parking lot so impervious area could not be minimized. Landscaped areas were to the northern portion of the project site.

Did you identify and disperse runoff to adjacent pervious areas? If so, how? If not, why?

No, due to the site being over 85% impervious dispersing runoff to pervious areas is infeasible and therefore flow through biotreatment BMPs were selected.

Section C: Delineate Drainage Management Areas (DMAs)

Utilizing the procedure in Section 3.3 of the WQMP Guidance Document which discusses the methods of delineating and mapping your project site into individual DMAs, complete Table C.1 below to appropriately categorize the types of classification (e.g., Type A, Type B, etc.) per DMA for your project site. Upon completion of this table, this information will then be used to populate and tabulate the corresponding tables for their respective DMA classifications.

Table C.1 DMA Classifications

DMA Name or ID	Surface Type(s) ¹²	Area (Sq. Ft.)	DMA Type
DMA 1A	Landscaping	3,234	D
DMA 1B	Asphalt Concrete	6,128	D
DMA 2A	Landscaping	3,768	D
DMA 2B	Asphalt Concrete	6,372	D
DMA 3A	Landscaping	1,445	D
DMA 3B	Asphalt Concrete	5,900	D
DMA 4A	Landscaping	507	D
DMA 4B	Asphalt Concrete	2,070	D
DMA 5A	Landscaping	41,678	D
DMA 5B	Roof Tops	100,160	D
DMA 5C	Parking/Access	215,467	D

¹Reference Table 2-1 in the WQMP Guidance Document to populate this column

²If multi-surface provide back-up

Table C.2 Type 'A', Self-Treating Areas

DMA Name or ID	Area (Sq. Ft.)	Stabilization Type	Irrigation Type (if any)
N/A			

Table C.3 Type 'B', Self-Retaining Areas

Self-Retaining Area				Type 'C' DMAs that are draining to the Self-Retaining Area		
DMA Name/ ID	Post-project surface type	Area (square feet)	Storm Depth (inches)	DMA Name / ID	[C] from Table C.4 =	Required Retention Depth (inches)
		[A]	[B]		[C]	
N/A						

--	--	--	--	--	--	--

$$[D] = [B] + \frac{[B] \cdot [C]}{[A]}$$

Table C.4 Type 'C', Areas that Drain to Self-Retaining Areas

DMA					Receiving Self-Retaining DMA		
DMA Name/ ID	Area (square feet)	Post-project surface type	Impervious fraction	Product	DMA name /ID	Area (square feet)	Ratio
	[A]		[B]	[C] = [A] x [B]		[D]	[C]/[D]
N/A							

Table C.5 Type 'D', Areas Draining to BMPs

DMA Name or ID	BMP Name or ID
DMA 1A	BMP 1 Bioswale
DMA 1B	BMP 1 Bioswale
DMA 2A	BMP 2 Bioswale
DMA 2B	BMP 2 Bioswale
DMA 3A	BMP 3 Bioswale
DMA 3B	BMP 3 Bioswale
DMA 4A	BMP 4 Bioswale
DMA 4B	BMP 4 Bioswale
DMA 5A	BMP 5 Modular Wetland System
DMA 5B	BMP 5 Modular Wetland System
DMA 5C	BMP 5 Modular Wetland System

Note: More than one drainage management area can drain to a single LID BMP, however, one drainage management area may not drain to more than one BMP.

Section D: Implement LID BMPs

D.1 Infiltration Applicability

Is there an approved downstream ‘Highest and Best Use’ for stormwater runoff (see discussion in Chapter 2.4.4 of the WQMP Guidance Document for further details)? Y N

If yes has been checked, Infiltration BMPs shall not be used for the site; proceed to section D.3

If no, continue working through this section to implement your LID BMPs. It is recommended that you contact your Co-Permittee to verify whether or not your project discharges to an approved downstream ‘Highest and Best Use’ feature.

Geotechnical Report

A Geotechnical Report or Phase I Environmental Site Assessment may be required by the Copermitee to confirm present and past site characteristics that may affect the use of Infiltration BMPs. In addition, the Co-Permittee, at their discretion, may not require a geotechnical report for small projects as described in Chapter 2 of the WQMP Guidance Document. If a geotechnical report has been prepared, include it in Appendix 3. In addition, if a Phase I Environmental Site Assessment has been prepared, include it in Appendix 4.

Is this project classified as a small project consistent with the requirements of Chapter 2 of the WQMP Guidance Document? Y N

Infiltration Feasibility

Table D.1 below is meant to provide a simple means of assessing which DMAs on your site support Infiltration BMPs and is discussed in the WQMP Guidance Document in Chapter 2.4.5. Check the appropriate box for each question and then list affected DMAs as applicable. If additional space is needed, add a row below the corresponding answer.

Table D.1 Infiltration Feasibility

Does the project site...	YES	NO
...have any DMAs with a seasonal high groundwater mark shallower than 10 feet? If Yes, list affected DMAs:		X
...have any DMAs located within 100 feet of a water supply well? If Yes, list affected DMAs:		X
...have any areas identified by the geotechnical report as posing a public safety risk where infiltration of stormwater could have a negative impact? If Yes, list affected DMAs:		X
...have measured in-situ infiltration rates of less than 1.6 inches / hour? If Yes, list affected DMAs: All DA 1, 2, 3, 4, and 5.	X	
...have significant cut and/or fill conditions that would preclude in-situ testing of infiltration rates at the final infiltration surface? If Yes, list affected DMAs:		X
...geotechnical report identify other site-specific factors that would preclude effective and safe infiltration? Describe here:		X

If you answered “Yes” to any of the questions above for any DMA, Infiltration BMPs should not be used for those DMAs and you should proceed to the assessment for Harvest and Use below.

D.2 Harvest and Use Assessment

Please check what applies:

- Reclaimed water will be used for the non-potable water demands for the project.
- Downstream water rights may be impacted by Harvest and Use as approved by the Regional Board (verify with the Copermittee).
- The Design Capture Volume will be addressed using Infiltration Only BMPs. In such a case, Harvest and Use BMPs are still encouraged, but it would not be required if the Design Capture Volume will be infiltrated or evapotranspired.

If any of the above boxes have been checked, Harvest and Use BMPs need not be assessed for the site. If none of the above criteria applies, follow the steps below to assess the feasibility of irrigation use, toilet use and other non-potable uses (e.g., industrial use).

Irrigation Use Feasibility

Complete the following steps to determine the feasibility of harvesting stormwater runoff for Irrigation Use BMPs on your site:

Step 1: Identify the total area of irrigated landscape on the site, and the type of landscaping used.

Total Area of Irrigated Landscape: 1.2 Acres

Type of Landscaping (Conservation Design or Active Turf): Active Turf

Step 2: Identify the planned total of all impervious areas on the proposed project from which runoff might be feasibly captured and stored for irrigation use. Depending on the configuration of buildings and other impervious areas on the site, you may consider the site as a whole, or parts of the site, to evaluate reasonable scenarios for capturing and storing runoff and directing the stored runoff to the potential use(s) identified in Step 1 above.

Total Area of Impervious Surfaces: 7.7 Acres

Step 3: Cross reference the Design Storm depth for the project site (see Exhibit A of the WQMP Guidance Document) with the left column of Table 2-3 in Chapter 2 to determine the minimum area of Effective Irrigated Area per Tributary Impervious Area (EIATIA).

Enter your EIATIA factor: 0.60

Step 4: Multiply the unit value obtained from Step 3 by the total of impervious areas from Step 2 to develop the minimum irrigated area that would be required.

Minimum required irrigated area: 4.6 Acres

Step 5: Determine if harvesting stormwater runoff for irrigation use is feasible for the project by comparing the total area of irrigated landscape (Step 1) to the minimum required irrigated area (Step 4).

Minimum required irrigated area (Step 4)	Available Irrigated Landscape (Step 1)
4.6 Acres	1.2 Acres

Toilet Use Feasibility

Complete the following steps to determine the feasibility of harvesting stormwater runoff for toilet flushing uses on your site:

Step 1: Identify the projected total number of daily toilet users during the wet season, and account for any periodic shut downs or other lapses in occupancy:

Projected Number of Daily Toilet Users: 185

Project Type: Industrial

Step 2: Identify the planned total of all impervious areas on the proposed project from which runoff might be feasibly captured and stored for toilet use. Depending on the configuration of buildings and other impervious areas on the site, you may consider the site as a whole, or parts of the site, to evaluate reasonable scenarios for capturing and storing runoff and directing the stored runoff to the potential use(s) identified in Step 1 above.

Total Area of Impervious Surfaces: 7.7 Acres

Step 3: Enter the Design Storm depth for the project site (see Exhibit A) into the left column of Table 2-2 in Chapter 2 to determine the minimum number of toilet users per tributary impervious acre (TUTIA).

Enter your TUTIA factor: 185

Step 4: Multiply the unit value obtained from Step 3 by the total of impervious areas from Step 2 to develop the minimum number of toilet users that would be required.

Minimum number of toilet users: 1,425

Step 5: Determine if harvesting stormwater runoff for toilet flushing use is feasible for the project by comparing the Number of Daily Toilet Users (Step 1) to the minimum required number of toilet users (Step 4).

Minimum required Toilet Users (Step 4)	Projected number of toilet users (Step 1)
1,425	185

Other Non-Potable Use Feasibility

Are there other non-potable uses for stormwater runoff on the site (e.g. industrial use)? See Chapter 2 of the Guidance for further information. If yes, describe below. If no, write N/A.

N/A

Step 1: Identify the projected average daily non-potable demand, in gallons per day, during the wet season and accounting for any periodic shut downs or other lapses in occupancy or operation.

Average Daily Demand: N/A

Step 2: Identify the planned total of all impervious areas on the proposed project from which runoff might be feasibly captured and stored for the identified non-potable use. Depending on the configuration of buildings and other impervious areas on the site, you may consider the site as a whole, or parts of the site, to evaluate reasonable scenarios for capturing and storing runoff and directing the stored runoff to the potential use(s) identified in Step 1 above.

Total Area of Impervious Surfaces: N/A

Step 3: Enter the Design Storm depth for the project site (see Exhibit A) into the left column of Table 2-4 in Chapter 2 to determine the minimum demand for non-potable uses per tributary impervious acre.

Enter the factor from Table 2-4: N/A

Step 4: Multiply the unit value obtained from Step 3 by the total of impervious areas from Step 2 to develop the minimum number of gallons per day of non-potable use that would be required.

Minimum required use: N/A

Step 5: Determine if harvesting stormwater runoff for other non-potable use is feasible for the project by comparing the projected average daily use (Step 1) to the minimum required non-potable use (Step 4).

Minimum required non-potable use (Step 4)	Projected average daily use (Step 1)
N/A	N/A

If Irrigation, Toilet and Other Use feasibility anticipated demands are less than the applicable minimum values, Harvest and Use BMPs are not required and you should proceed to utilize LID Bioretention and Biotreatment per Section 3.4.2 of the WQMP Guidance Document.

D.3 Bioretention and Biotreatment Assessment

Other LID Bioretention and Biotreatment BMPs as described in Chapter 2.4.7 of the WQMP Guidance Document are feasible on nearly all development sites with sufficient advance planning.

Select one of the following:

- LID Bioretention/Biotreatment BMPs will be used for some or all DMAs of the project as noted below in Section D.4 (note the requirements of Section 3.4.2 in the WQMP Guidance Document).
- A site-specific analysis demonstrating the technical infeasibility of all LID BMPs has been performed and is included in Appendix 5. If you plan to submit an analysis demonstrating the technical infeasibility of LID BMPs, request a pre-submittal meeting with the Copermittee to discuss this option. Proceed to Section E to document your alternative compliance measures.

D.4 Feasibility Assessment Summaries

From the Infiltration, Harvest and Use, Bioretention and Biotreatment Sections above, complete Table D.2 below to summarize which LID BMPs are technically feasible, and which are not, based upon the established hierarchy.

Table D.2 LID Prioritization Summary Matrix

DMA Name/ID	LID BMP Hierarchy				No LID (Alternative Compliance)
	1. Infiltration	2. Harvest and use	3. Bioretention	4. Biotreatment	
DMA 1A	<input type="checkbox"/>	<input type="checkbox"/>	<input checked="" type="checkbox"/>	<input type="checkbox"/>	<input type="checkbox"/>
DMA 1B	<input type="checkbox"/>	<input type="checkbox"/>	<input checked="" type="checkbox"/>	<input type="checkbox"/>	<input type="checkbox"/>
DMA 2A	<input type="checkbox"/>	<input type="checkbox"/>	<input checked="" type="checkbox"/>	<input type="checkbox"/>	<input type="checkbox"/>
DMA 2B	<input type="checkbox"/>	<input type="checkbox"/>	<input checked="" type="checkbox"/>	<input type="checkbox"/>	<input type="checkbox"/>
DMA 3A	<input type="checkbox"/>	<input type="checkbox"/>	<input checked="" type="checkbox"/>	<input type="checkbox"/>	<input type="checkbox"/>
DMA 3B	<input type="checkbox"/>	<input type="checkbox"/>	<input checked="" type="checkbox"/>	<input type="checkbox"/>	<input type="checkbox"/>
DMA 4A	<input type="checkbox"/>	<input type="checkbox"/>	<input checked="" type="checkbox"/>	<input type="checkbox"/>	<input type="checkbox"/>
DMA 4B	<input type="checkbox"/>	<input type="checkbox"/>	<input checked="" type="checkbox"/>	<input type="checkbox"/>	<input type="checkbox"/>
DMA 5A	<input type="checkbox"/>	<input type="checkbox"/>	<input type="checkbox"/>	<input checked="" type="checkbox"/>	<input type="checkbox"/>
DMA 5B	<input type="checkbox"/>	<input type="checkbox"/>	<input type="checkbox"/>	<input checked="" type="checkbox"/>	<input type="checkbox"/>
DMA 5C	<input type="checkbox"/>	<input type="checkbox"/>	<input type="checkbox"/>	<input checked="" type="checkbox"/>	<input type="checkbox"/>

For those DMAs where LID BMPs are not feasible, provide a brief narrative below summarizing why they are not feasible, include your technical infeasibility criteria in Appendix 5, and proceed to Section E below to document Alternative Compliance measures for those DMAs. Recall that each proposed DMA must pass through the LID BMP hierarchy before alternative compliance measures may be considered.

D.5 LID BMP Sizing

Each LID BMP must be designed to ensure that the Design Capture Volume will be addressed by the selected BMPs. First, calculate the Design Capture Volume for each LID BMP using the V_{BMP} worksheet in Appendix F of the LID BMP Design Handbook. Second, design the LID BMP to meet the required V_{BMP} using a method approved by the Copermittee. Utilize the worksheets found in the LID BMP Design Handbook or consult with your Copermittee to assist you in correctly sizing your LID BMPs. Complete Table D.3 below to document the Design Capture Volume and the Proposed Volume for each LID BMP. Provide the completed design procedure sheets for each LID BMP in Appendix 6. You may add additional rows to the table below as needed.

Table D.3 DCV Calculations for LID BMPs

DMA Type/ID	DMA Area (square feet)	Post-Project Surface Type	Effective Impervious Fraction, I_f	DMA Runoff Factor	DMA Areas x Runoff Factor	<i>BMP 1 – Bioswale</i>		
	[A]		[B]	[C]	[A] x [C]			
DMA 1A	3,234	<i>Ornamental Landscaping</i>	0.1	0.11	357.2	<i>Design Storm Depth (in.)</i>	<i>Design capture Volume, VBMP (cubic feet)</i>	<i>Proposed Volume on plans (cubic feet)</i>
DMA 1B	6,128	<i>Asphalt</i>	1.0	0.89	5466.2			
	9,362				5,823.4	0.62	300.9	503.4

[B], [C] is obtained as described in Section 2.3.1 of the WQMP Guidance Document

[E] is obtained from Exhibit A in the WQMP Guidance Document

[G] is obtained from a design procedure sheet, such as in LID BMP Design Handbook and placed in Appendix 6

Table D.4 DCV Calculations for LID BMPs

DMA Type/ID	DMA Area (square feet)	Post-Project Surface Type	Effective Impervious Fraction, I _f	DMA Runoff Factor	DMA Areas x Runoff Factor	BMP 2 – Bioswale		
	[A]				[C]			
DMA 2A	3,768	<i>Ornamental Landscaping</i>	0.1	0.11	416.2	<i>Design Storm Depth (in.)</i>	<i>Design capture Volume, VBMP (cubic feet)</i>	<i>Proposed Volume on plans (cubic feet)</i>
DMA 2B	6,372	<i>Asphalt</i>	1.0	0.89	5,683.8			
	10,140				6,100	0.62	315.2	503.4

[B], [C] is obtained as described in Section 2.3.1 of the WQMP Guidance Document

[E] is obtained from Exhibit A in the WQMP Guidance Document

[G] is obtained from a design procedure sheet, such as in LID BMP Design Handbook and placed in Appendix 6

Table D.5 DCV Calculations for LID BMPs

DMA Type/ID	DMA Area (square feet)	Post-Project Surface Type	Effective Impervious Fraction, I _f	DMA Runoff Factor	DMA Areas x Runoff Factor	BMP 3 – Bioswale		
	[A]				[C]			
DMA 3A	1,445	<i>Ornamental Landscaping</i>	0.1	0.11	159.6	<i>Design Storm Depth (in.)</i>	<i>Design capture Volume, VBMP (cubic feet)</i>	<i>Proposed Volume on plans (cubic feet)</i>
DMA 3B	5,900	<i>Asphalt</i>	1.0	0.89	5,262.8			
	7,345				5,422.4	0.62	280.2	521.0

[B], [C] is obtained as described in Section 2.3.1 of the WQMP Guidance Document

[E] is obtained from Exhibit A in the WQMP Guidance Document

[G] is obtained from a design procedure sheet, such as in LID BMP Design Handbook and placed in Appendix 6

Table D.6 DCV Calculations for LID BMPs

DMA Type/ID	DMA Area (square feet)	Post-Project Surface Type	Effective Impervious Fraction, I _f	DMA Runoff Factor	DMA Areas x Runoff Factor	BMP 4 – Bioswale		
	[A]				[B]			
DMA 4A	507	<i>Ornamental Landscaping</i>	0.1	0.11	56	<i>Design Storm Depth (in.)</i>	<i>Design capture Volume, VBMP (cubic feet)</i>	<i>Proposed Volume on plans (cubic feet)</i>
DMA 4B	2,070	<i>Asphalt</i>	1.0	0.89	1,846.4			
	2,577				1,902	0.62	98.3	189.7

[B], [C] is obtained as described in Section 2.3.1 of the WQMP Guidance Document

[E] is obtained from Exhibit A in the WQMP Guidance Document

[G] is obtained from a design procedure sheet, such as in LID BMP Design Handbook and placed in Appendix 6

Table D.7 DCV Calculations for LID BMPs

DMA Type/ID	DMA Area (square feet)	Post-Project Surface Type	Effective Impervious Fraction, I _f	DMA Runoff Factor	DMA Areas x Runoff Factor	BMP 5 – Modular Wetland System		
	[A]				[B]			
DMA 5A	41,678	<i>Ornamental Landscaping</i>	0.1	0.11	4,603.7	<i>Design Storm Depth (in.)</i>	<i>Design capture Volume, VBMP (cubic feet)</i>	<i>Proposed Volume on plans (cubic feet)</i>
DMA 5B	100,160	<i>Roofs</i>	1.0	0.89	89,342.7			
DMA 5C	215,467	<i>Asphalt</i>	1.0	0.89	192,196.6			
	357,305				286,143	0.62	14,784.1	15,227.5

[B], [C] is obtained as described in Section 2.3.1 of the WQMP Guidance Document

[E] is obtained from Exhibit A in the WQMP Guidance Document

[G] is obtained from a design procedure sheet, such as in LID BMP Design Handbook and placed in Appendix 6

Section E: Alternative Compliance (LID Waiver Program)

LID BMPs are expected to be feasible on virtually all projects. Where LID BMPs have been demonstrated to be infeasible as documented in Section D, other Treatment Control BMPs must be used (subject to LID waiver approval by the Copermittee). Check one of the following Boxes:

LID Principles and LID BMPs have been incorporated into the site design to fully address all Drainage Management Areas. No alternative compliance measures are required for this project and thus this Section is not required to be completed.

- Or -

The following Drainage Management Areas are unable to be addressed using LID BMPs. A site-specific analysis demonstrating technical infeasibility of LID BMPs has been approved by the Co-Permittee and included in Appendix 5. Additionally, no downstream regional and/or sub-regional LID BMPs exist or are available for use by the project. The following alternative compliance measures on the following pages are being implemented to ensure that any pollutant loads expected to be discharged by not incorporating LID BMPs, are fully mitigated.

E.1 Identify Pollutants of Concern

Utilizing Table A.1 from Section A above which noted your project's receiving waters and their associated EPA approved 303(d) listed impairments, cross reference this information with that of your selected Priority Development Project Category in Table E.1 below. If the identified General Pollutant Categories are the same as those listed for your receiving waters, then these will be your Pollutants of Concern and the appropriate box or boxes will be checked on the last row. The purpose of this is to document compliance and to help you appropriately plan for mitigating your Pollutants of Concern in lieu of implementing LID BMPs.

Table E.1 Potential Pollutants by Land Use Type

Priority Development Project Categories and/or Project Features (check those that apply)	General Pollutant Categories							
	Bacterial Indicators	Metals	Nutrients	Pesticides	Toxic Organic Compounds	Sediments	Trash & Debris	Oil & Grease
<input type="checkbox"/> Detached Residential Development	P	N	P	P	N	P	P	P
<input type="checkbox"/> Attached Residential Development	P	N	P	P	N	P	P	P ⁽²⁾
<input checked="" type="checkbox"/> Commercial/Industrial Development	P ⁽³⁾	P	P ⁽¹⁾	P ⁽¹⁾	P ⁽⁵⁾	P ⁽¹⁾	P	P
<input type="checkbox"/> Automotive Repair Shops	N	P	N	N	P ^(4, 5)	N	P	P
<input type="checkbox"/> Restaurants (>5,000 ft ²)	P	N	N	N	N	N	P	P
<input type="checkbox"/> Hillside Development (>5,000 ft ²)	P	N	P	P	N	P	P	P
<input checked="" type="checkbox"/> Parking Lots (>5,000 ft ²)	P ⁽⁶⁾	P	P ⁽¹⁾	P ⁽¹⁾	P ⁽⁴⁾	P ⁽¹⁾	P	P
<input type="checkbox"/> Retail Gasoline Outlets	N	P	N	N	P	N	P	P
Project Priority Pollutant(s) of Concern	<input type="checkbox"/>	<input type="checkbox"/>	<input type="checkbox"/>	<input type="checkbox"/>	<input type="checkbox"/>	<input type="checkbox"/>	<input type="checkbox"/>	<input type="checkbox"/>

P = Potential

N = Not Potential

⁽¹⁾ *A potential Pollutant if non-native landscaping exists or is proposed onsite; otherwise not expected*

⁽²⁾ *A potential Pollutant if the project includes uncovered parking areas; otherwise not expected*

⁽³⁾ *A potential Pollutant is land use involving animal waste*

⁽⁴⁾ *Specifically petroleum hydrocarbons*

⁽⁵⁾ *Specifically solvents*

⁽⁶⁾ *Bacterial indicators are routinely detected in pavement runoff*

E.2 Stormwater Credits

Projects that cannot implement LID BMPs but nevertheless implement smart growth principles are potentially eligible for Stormwater Credits. Utilize Table 3-8 within the WQMP Guidance Document to identify your Project Category and its associated Water Quality Credit. If not applicable, write N/A.

Table E.2 Water Quality Credits

Qualifying Project Categories	Credit Percentage ²
N/A	
Total Credit Percentage ¹	

¹Cannot Exceed 50%

²Obtain corresponding data from Table 3-8 in the WQMP Guidance Document

E.3 Sizing Criteria

After you appropriately considered Stormwater Credits for your project, utilize Table E.3 below to appropriately size them to the DCV, or Design Flow Rate, as applicable. Please reference Chapter 3.5.2 of the WQMP Guidance Document for further information.

Table E.3 Treatment Control BMP Sizing

DMA Type/ID	DMA Area (square feet)	Post-Project Surface Type	Effective Impervious Fraction, I _r	DMA Runoff Factor	DMA Area x Runoff Factor	Enter BMP Name / Identifier Here			
	[A]		[B]	[C]	[A] x [C]				
N/A									
						Design Storm Depth (in)	Minimum Design Capture Volume or Design Flow Rate (cubic feet or cfs)	Total Storm Water Credit % Reduction	Proposed Volume or Flow on Plans (cubic feet or cfs)
	$A_T = \sum[A]$				$\Sigma = [D]$	[E]	$[F] = \frac{[D] \times [E]}{[G]}$	$[F] \times (1-[H])$	[I]

[B], [C] is obtained as described in Section 2.3.1 from the WQMP Guidance Document

[E] is for Flow-Based Treatment Control BMPs [E] = .2, for Volume-Based Control Treatment BMPs, [E] obtained from Exhibit A in the WQMP Guidance Document

[G] is for Flow-Based Treatment Control BMPs [G] = 43,560, for Volume-Based Control Treatment BMPs, [G] = 12

[H] is from the Total Credit Percentage as Calculated from Table E.2 above

[I] as obtained from a design procedure sheet from the BMP manufacturer and should be included in Appendix 6

E.4 Treatment Control BMP Selection

Treatment Control BMPs typically provide proprietary treatment mechanisms to treat potential pollutants in runoff, but do not sustain significant biological processes. Treatment Control BMPs must have a removal efficiency of a medium or high effectiveness as quantified below:

- **High:** equal to or greater than 80% removal efficiency
- **Medium:** between 40% and 80% removal efficiency

Such removal efficiency documentation (e.g., studies, reports, etc.) as further discussed in Chapter 3.5.2 of the WQMP Guidance Document, must be included in Appendix 6. In addition, ensure that proposed Treatment Control BMPs are properly identified on the WQMP Site Plan in Appendix 1.

Table E.4 Treatment Control BMP Selection

Selected Treatment Control BMP Name or ID ¹	Priority Pollutant(s) of Concern to Mitigate ²	Removal Efficiency Percentage ³
N/A		

¹ Treatment Control BMPs must not be constructed within Receiving Waters. In addition, a proposed Treatment Control BMP may be listed more than once if they possess more than one qualifying pollutant removal efficiency.

² Cross Reference Table E.1 above to populate this column.

³ As documented in a Co-Permittee Approved Study and provided in Appendix 6.

Section F: Hydromodification

F.1 Hydrologic Conditions of Concern (HCOC) Analysis

Once you have determined that the LID design is adequate to address water quality requirements, you will need to assess if the proposed LID Design may still create a HCOC. Review Chapters 2 and 3 (including Figure 3-7) of the WQMP Guidance Document to determine if your project must mitigate for Hydromodification impacts. If your project meets one of the following criteria which will be indicated by the check boxes below, you do not need to address Hydromodification at this time. However, if the project does not qualify for Exemptions 1, 2 or 3, then additional measures must be added to the design to comply with HCOC criteria. This is discussed in further detail below in Section F.2.

HCOC EXEMPTION 1: The Priority Development Project disturbs less than one acre. The Copermitttee has the discretion to require a Project-Specific WQMP to address HCOCs on projects less than one acre on a case by case basis. The disturbed area calculation should include all disturbances associated with larger common plans of development.

Does the project qualify for this HCOC Exemption? Y N

If Yes, HCOC criteria do not apply.

HCOC EXEMPTION 2: The volume and time of concentration¹ of storm water runoff for the post-development condition is not significantly different from the pre-development condition for a 2-year return frequency storm (a difference of 5% or less is considered insignificant) using one of the following methods to calculate:

- Riverside County Hydrology Manual
- Technical Release 55 (TR-55): Urban Hydrology for Small Watersheds (NRCS 1986), or derivatives thereof, such as the Santa Barbara Urban Hydrograph Method
- Other methods acceptable to the Co-Permittee

Does the project qualify for this HCOC Exemption? Y N

If Yes, report results in Table F.1 below and provide your substantiated hydrologic analysis in Appendix 7.

Table F.1 Hydrologic Conditions of Concern Summary

	2 year – 24 hour		
	Pre-condition	Post-condition	% Difference
Time of Concentration	N/A	INSERT VALUE	INSERT VALUE
Volume (Cubic Feet)	N/A	INSERT VALUE	INSERT VALUE

¹ Time of concentration is defined as the time after the beginning of the rainfall when all portions of the drainage basin are contributing to flow at the outlet.

HCOC EXEMPTION 3: All downstream conveyance channels to an adequate sump (for example, Prado Dam, Lake Elsinore, Canyon Lake, Santa Ana River, or other lake, reservoir or naturally erosion resistant feature) that will receive runoff from the project are engineered and regularly maintained to ensure design flow capacity; no sensitive stream habitat areas will be adversely affected; or are not identified on the Co-Permittees Hydromodification Susceptibility Maps.

Does the project qualify for this HCOC Exemption? Y N

If Yes, HCOC criteria do not apply and note below which adequate sump applies to this HCOC qualifier:

F.2 HCOC Mitigation

If none of the above HCOC Exemption Criteria are applicable, HCOC criteria is considered mitigated if they meet one of the following conditions:

- a. Additional LID BMPS are implemented onsite or offsite to mitigate potential erosion or habitat impacts as a result of HCOCs. This can be conducted by an evaluation of site-specific conditions utilizing accepted professional methodologies published by entities such as the California Stormwater Quality Association (CASQA), the Southern California Coastal Water Research Project (SCCRWP), or other Co-Permittee approved methodologies for site-specific HCOC analysis.
- b. The project is developed consistent with an approved Watershed Action Plan that addresses HCOC in Receiving Waters.
- c. Mimicking the pre-development hydrograph with the post-development hydrograph, for a 2-year return frequency storm. Generally, the hydrologic conditions of concern are not significant, if the post-development hydrograph is no more than 10% greater than pre-development hydrograph. In cases where excess volume cannot be infiltrated or captured and reused, discharge from the site must be limited to a flow rate no greater than 110% of the pre-development 2-year peak flow.

Be sure to include all pertinent documentation used in your analysis of the items a, b or c in Appendix 7.

Underground detention chambers will be utilized to contain runoff and slowly release runoff via pump & Modular Wetlands System into Edgemont Channel. Proposed conditions will mimic pre-existing conditions by utilization of the detention chambers, pump, and Modular Wetland System. After the inclusion of the detention chambers, pump, and MWS the post-development conditions are less than pre-development conditions.

	2 year – 24 hour		
	Pre-condition	Post-condition	Post-condition with MWS
Flow Rate (cfs)	0.252	1.384	0.23

See Appendix 7 for more information.

Section G: Source Control BMPs

Source control BMPs include permanent, structural features that may be required in your project plans — such as roofs over and berms around trash and recycling areas — and Operational BMPs, such as regular sweeping and “housekeeping”, that must be implemented by the site’s occupant or user. The MEP standard typically requires both types of BMPs. In general, Operational BMPs cannot be substituted for a feasible and effective permanent BMP. Using the Pollutant Sources/Source Control Checklist in Appendix 8, review the following procedure to specify Source Control BMPs for your site:

1. **Identify Pollutant Sources:** Review Column 1 in the Pollutant Sources/Source Control Checklist. Check off the potential sources of Pollutants that apply to your site.
2. **Note Locations on Project-Specific WQMP Exhibit:** Note the corresponding requirements listed in Column 2 of the Pollutant Sources/Source Control Checklist. Show the location of each Pollutant source and each permanent Source Control BMP in your Project-Specific WQMP Exhibit located in Appendix 1.
3. **Prepare a Table and Narrative:** Check off the corresponding requirements listed in Column 3 in the Pollutant Sources/Source Control Checklist. In the left column of Table G.1 below, list each potential source of runoff Pollutants on your site (from those that you checked in the Pollutant Sources/Source Control Checklist). In the middle column, list the corresponding permanent, Structural Source Control BMPs (from Columns 2 and 3 of the Pollutant Sources/Source Control Checklist) used to prevent Pollutants from entering runoff. **Add additional narrative** in this column that explains any special features, materials or methods of construction that will be used to implement these permanent, Structural Source Control BMPs.
4. **Identify Operational Source Control BMPs:** To complete your table, refer once again to the Pollutant Sources/Source Control Checklist. List in the right column of your table the Operational BMPs that should be implemented as long as the anticipated activities continue at the site. Copermittee stormwater ordinances require that applicable Source Control BMPs be implemented; the same BMPs may also be required as a condition of a use permit or other revocable Discretionary Approval for use of the site.

Table G.1 Permanent and Operational Source Control Measures

Potential Sources of Runoff pollutants	Permanent Structural Source Control BMPs	Operational Source Control BMPs
A. On-site storm drain inlets	Mark all inlets with the words “Only Rain Down the Storm Drain” or similar. Catch Basin Markers may be available from the Riverside County Flood Control and Water Conservation District, call 951-955-1200 to verify.	Maintain and periodically repaint or replace inlet markings. Provide stormwater pollution prevention information to new site owners, lessees, or operators. See applicable operational BMPs in Fact Sheet SC-44, “Drainage System Maintenance,” in the CASQA Stormwater Quality

		<p>Handbooks at www.cabmphandbooks.com</p> <p>Include the following in lease agreements: "Tenant shall not allow anyone to discharge anything to storm drains or to store or deposit materials so as to create a potential discharge to storm drains."</p>
B. Interior floor drains	Interior floor drains will be plumbed to sanitary sewer.	Inspect and maintain drains to prevent blockages and overflow.
D1. Landscape / Outdoor Pesticide Use	<p>Landscape plans will minimize irrigation and runoff, to promote surface infiltration where appropriate, and to minimize the use of fertilizers and pesticides that can contribute to stormwater pollution.</p> <p>Pest-resistant plans will be used adjacent to hardscape.</p> <p>The landscape plans will consider plants appropriate to the site soils, slopes, climate, sun, wind, rain, land use, air movement, ecological consistency, and plant interactions.</p>	<p>Maintain landscaping only using minimum pesticides, when needed.</p> <p>See Appendix 10 for "Landscape and Gardening" brochure by RCFlood.</p> <p>Provide Integrated Pest Management (IPM) information to new owners, lessees and operators upon occupancy and annually thereafter. IPM is an effective and environmentally sensitive approach to pest management.</p>
J. Refuse Areas	<p>Site refuse will be handled by contractor on a weekly basis.</p> <p>Signs will be posted on or near dumpsters with the words "Do not dump hazardous materials here" or similar.</p>	<p>A minimum of two receptacles will be provided and located indoors. Receptacles are to be inspected daily and repairs or replacements to leaky receptacles will be completed immediately. Receptacles are to remain covered when not in use. Dumping of liquid or hazardous wastes is prohibited. A "no hazardous materials" sign will be posted. Spills will be cleaned immediately upon discovery. Spill control materials will be available onsite. See Appendix 10 for CASQA fact sheet SC-34 for "Waste Handling and Disposal."</p>

K. Industrial processes	All process activities to be performed indoors. No processes to drain to exterior or to storm drain system.	See Appendix 10 for CASQA fact sheet SC-10 for “Non-Stormwater Discharges”
M. Loading Docks		Move loaded and unloaded items indoors as soon as possible. See Fact Sheet SC-30, “Outdoor Loading and Unloading,” in the CASQA Stormwater Quality Handbooks at www.cabmphandbooks.com
O. Miscellaneous Drain or Wash Water or Other Sources Condensate Drain lines Roofing, gutters, and trim	Condensate drain lines may discharge to landscaped areas if the flow is small enough that runoff will not occur. Condensate drain lines may not discharge to the storm drain system. Avoid roofing, gutters, and trim made of copper or other unprotected metals that may leach into runoff.	
P. Plazas, sidewalks, and parking lots		Sweep plazas, sidewalks, and parking lots monthly to prevent accumulation of litter and debris. Collect debris from pressure washing to prevent entry into the storm drain system. Collect washwater containing any cleaning agent or degreaser and discharge to the sanitary sewer not to a storm drain.

Section H: Construction Plan Checklist

Populate Table H.1 below to assist the plan checker in an expeditious review of your project. The first two columns will contain information that was prepared in previous steps, while the last column will be populated with the corresponding plan sheets. This table is to be completed with the submittal of your final Project-Specific WQMP.

Table H.1 Construction Plan Cross-reference

BMP No. or ID	BMP Identifier and Description	Corresponding Plan Sheet(s)	BMP Location (Lat/Long)
1	Bioswale	C-1	33°55'19.12"N, 117°17'6.83"W
2	Bioswale	C-1	33°55'20.76"N, 117°17'7.59"W
3	Bioswale	C-1	33°55'20.98"N, 117°17'0.50"W
4	Bioswale	C-1	33°55'22.72"N, 117°17'0.58"W
5	MWS	C-1	33°55'21.97"N, 117°17'0.78"W

Note that the updated table — or Construction Plan WQMP Checklist — is **only a reference tool** to facilitate an easy comparison of the construction plans to your Project-Specific WQMP. Co-Permittee staff can advise you regarding the process required to propose changes to the approved Project-Specific WQMP.

Section I: Operation, Maintenance and Funding

The Copermittee will periodically verify that Stormwater BMPs on your site are maintained and continue to operate as designed. To make this possible, your Copermittee will require that you include in Appendix 9 of this Project-Specific WQMP:

1. A means to finance and implement facility maintenance in perpetuity, including replacement cost.
2. Acceptance of responsibility for maintenance from the time the BMPs are constructed until responsibility for operation and maintenance is legally transferred. A warranty covering a period following construction may also be required.
3. An outline of general maintenance requirements for the Stormwater BMPs you have selected.
4. Figures delineating and designating pervious and impervious areas, location, and type of Stormwater BMP, and tables of pervious and impervious areas served by each facility. Geo-locating the BMPs using a coordinate system of latitude and longitude is recommended to help facilitate a future statewide database system.
5. A separate list and location of self-retaining areas or areas addressed by LID Principles that do not require specialized O&M or inspections but will require typical landscape maintenance as noted in Chapter 5, pages 85-86, in the WQMP Guidance. Include a brief description of typical landscape maintenance for these areas.

Your local Co-Permittee will also require that you prepare and submit a detailed Stormwater BMP Operation and Maintenance Plan that sets forth a maintenance schedule for each of the Stormwater BMPs built on your site. An agreement assigning responsibility for maintenance and providing for inspections and certification may also be required.

Details of these requirements and instructions for preparing a Stormwater BMP Operation and Maintenance Plan are in Chapter 5 of the WQMP Guidance Document.

Maintenance Mechanism: Maintenance will be funded by owner. A complete maintenance agreement will be submitted with FWQMP.

Will the proposed BMPs be maintained by a Home Owners' Association (HOA) or Property Owners Association (POA)?

Y N

Include your Operation and Maintenance Plan and Maintenance Mechanism in Appendix 9. Additionally, include all pertinent forms of educational materials for those personnel that will be maintaining the proposed BMPs within this Project-Specific WQMP in Appendix 10.

Appendix 1: Maps and Site Plans

Location Map, WQMP Site Plan and Receiving Waters Map

REGIONAL VICINITY MAP

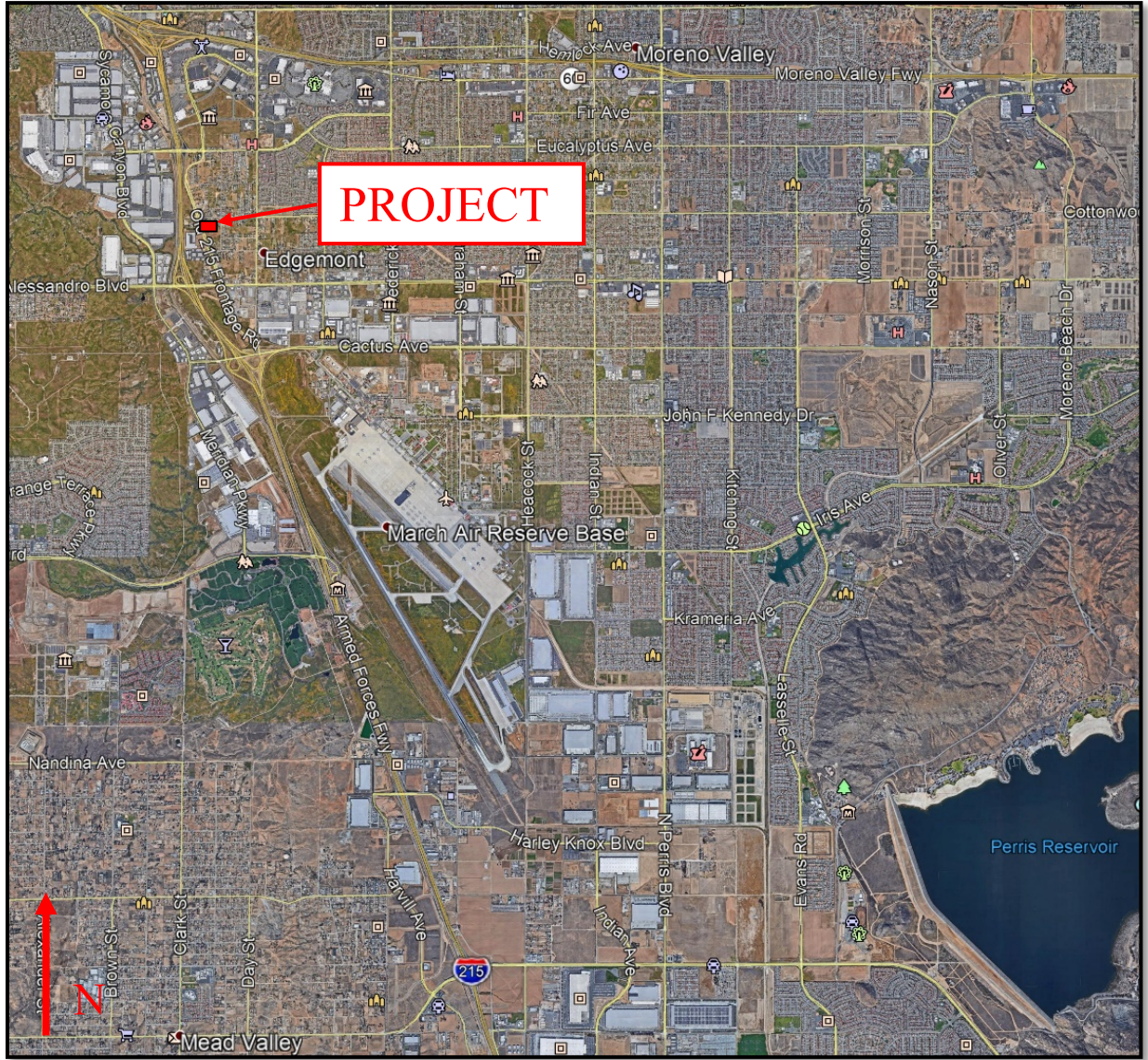

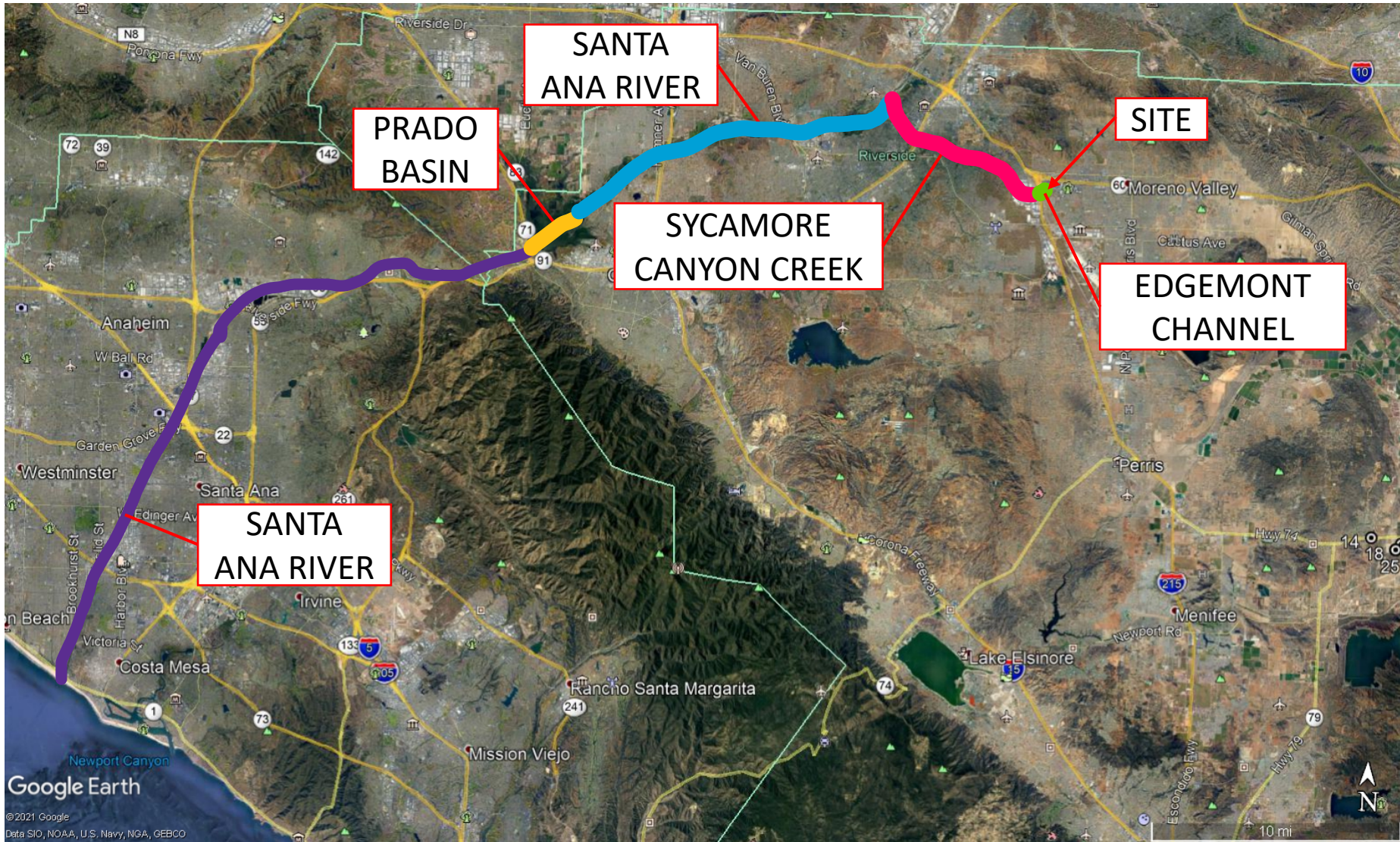

RECEIVING WATERS MAP

WATER QUALITY MANAGEMENT PLAN

OLD 215 INDUSTRIAL BUILDINGS APN: 263-190-012, 014-019, 036

CITY OF MORENO VALLEY, CA



SD-13 DETAIL

NOT TO SCALE

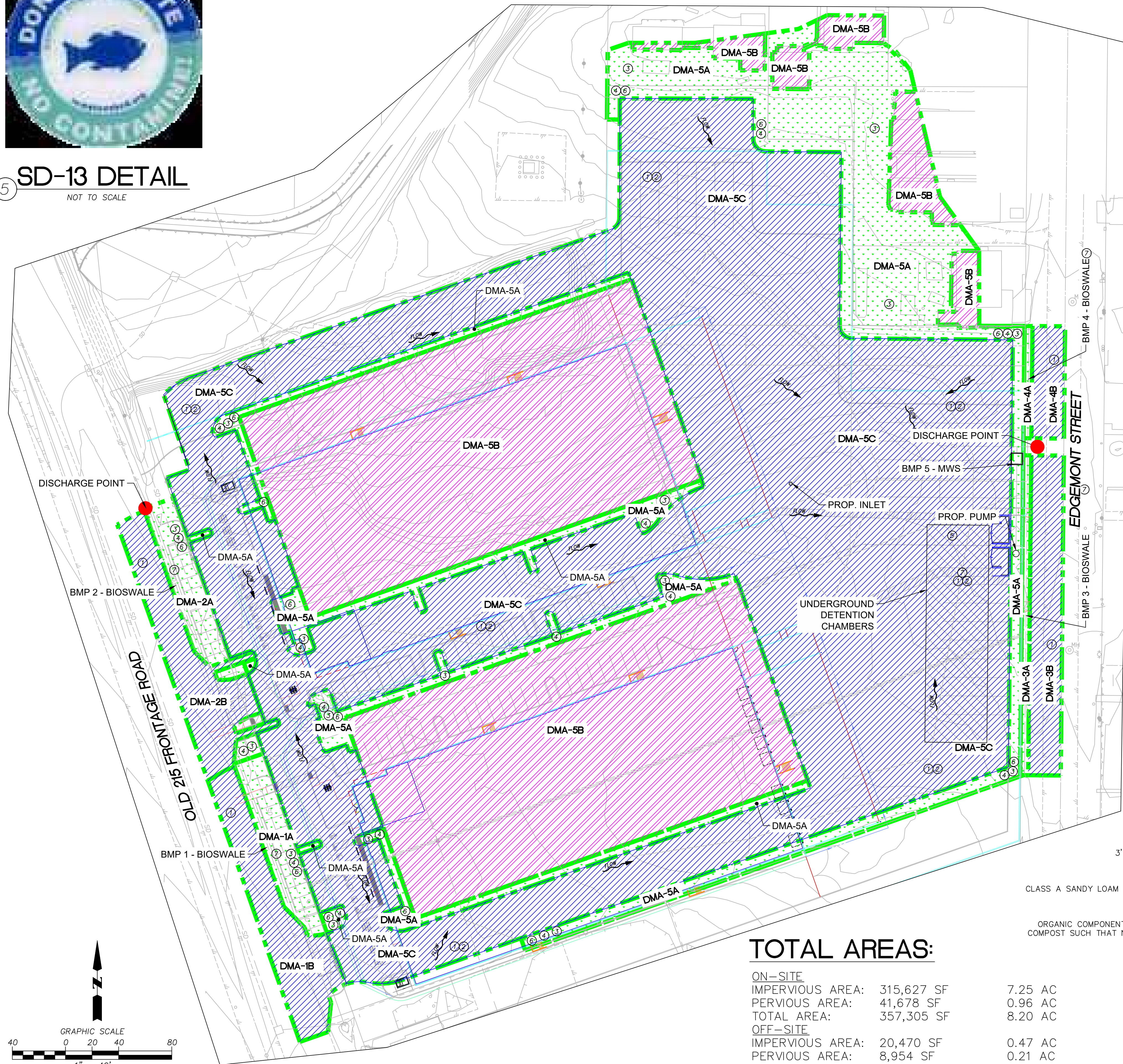

SOURCE CONTROL BMPs

- ① SC-70 ROAD AND STREET MAINTENANCE
- ② SC-71 PARKING LOT CLEANING
- ③ SC-73 LANDSCAPE MAINTENANCE
- ④ SD-12 EFFICIENT IRRIGATION
- ⑤ SD-13 STORM DRAIN SIGNAGE
- ⑥ N-3 LANDSCAPE MANAGEMENT
- ⑦ N-4 BMP MAINTENANCE

LEGEND

- DA DRAINAGE AREA
- DMA DRAINAGE MANAGEMENT AREA
- DRAINAGE MANAGEMENT AREA BOUNDARY
- ▨ AC OR PCC PAVEMENT (IMPERVIOUS) AREA
- ▨ ROOFS / BUILDING (IMPERVIOUS)
- ▨ NATURAL (SOIL TYPE A) (PERVIOUS) AREA

FLOW → FLOW DIRECTION

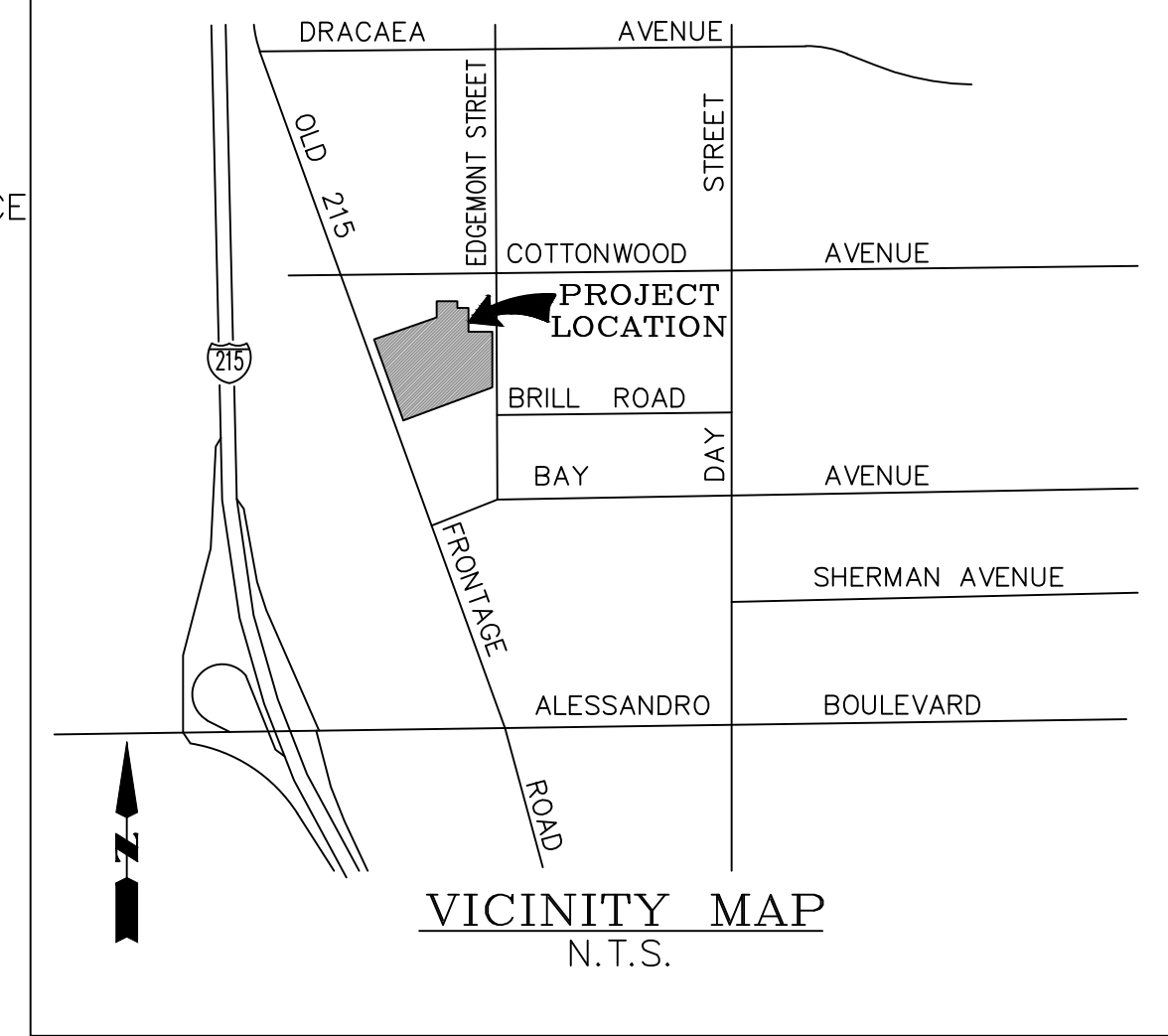

DMA CLASSIFICATIONS					
DMA NAME	SURFACE TYPE	IMPERVIOUS AREA (SF)	PERVIOUS AREA (SF)	DMA TYPE	BMP TYPE
DMA 1A	LANDSCAPING	0	3234	TYPE D	BIOSWALE
DMA 1B	ASPHALT / SIDEWALK	6,128	0	TYPE D	BIOSWALE
DMA 2A	LANDSCAPING	0	3768	TYPE D	BIOSWALE
DMA 2B	ASPHALT / SIDEWALK	6,372	0	TYPE D	BIOSWALE
DMA 3A	LANDSCAPING	0	1,445	TYPE D	BIOSWALE
DMA 3B	ASPHALT / SIDEWALK	5,900	0	TYPE D	BIOSWALE
DMA 4A	LANDSCAPING	0	507	TYPE D	BIOSWALE
DMA 4B	ASPHALT / SIDEWALK	2,070	0	TYPE D	BIOSWALE
DMA 5A	LANDSCAPING	0	41678	TYPE D	BIOTREATMENT MWS-L-8-8-V
DMA 5B	ROOFS	100,160	0	TYPE D	BIOTREATMENT MWS-L-8-8-V
DMA 5C	PARKING LOT	215,467	0	TYPE D	BIOTREATMENT MWS-L-8-8-V

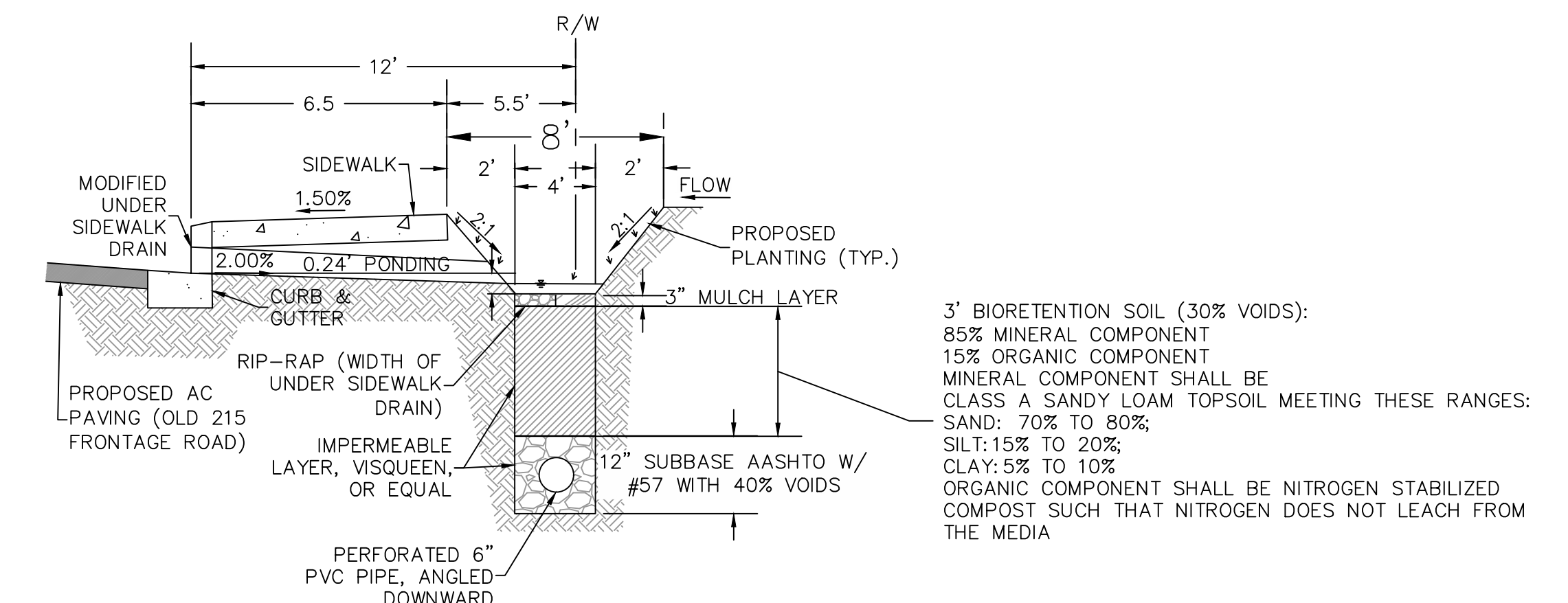

BIOSWALE DETAIL

FOR OLD 215 FRONTAGE ROAD

FOR EDGEMONT STREET

BIOSWALE DETAIL

FOR EDGEMONT STREET

TOTAL AREAS:

ON-SITE		
IMPERVIOUS AREA:	315,627 SF	7.25 AC
PERVIOUS AREA:	41,678 SF	0.96 AC
TOTAL AREA:	357,305 SF	8.20 AC
OFF-SITE		
IMPERVIOUS AREA:	20,470 SF	0.47 AC
PERVIOUS AREA:	8,954 SF	0.21 AC
TOTAL AREA:	29,424 SF	0.68 AC

3" BIORETENTION SOIL (30% VOIDS):
85% MINERAL COMPONENT
15% ORGANIC COMPONENT
MINERAL COMPONENT SHALL BE CLASS A SANDY LOAM TOPSOIL MEETING THESE RANGES:
SAND: 70% TO 80%;
SILT: 15% TO 20%;
CLAY: 5% TO 10%
ORGANIC COMPONENT SHALL BE NITROGEN STABILIZED COMPOST SUCH THAT NITROGEN DOES NOT LEACH FROM THE MEDIA

CASC
Engineering and Consulting

1470 EAST COOLEY DRIVE, COLTON, CA 92324
PH. (909) 783-0101 FAX (909) 783-0108
www.cascinc.com

Drawing Name: C:\Users\csc096\OneDrive\Moreno Valley\Engineering\WQMP\194-0003\WQMP.dwg
Last Update: Mar 17, 2022 9:46am by csc096

Appendix 2: Construction Plans

Grading and Drainage Plans

LEGAL DESCRIPTION

PARCEL 1: LOT 6 OF EDGEMONT TRACT NO. 2, AS SHOWN BY MAP ON FILE IN BOOK 12 PAGE 19 OF MAPS, RECORDS OF RIVERSIDE COUNTY, CALIFORNIA; EXCEPTING THEREFROM THE WESTERLY 72 FEET CONVEYED TO THE STATE OF CALIFORNIA BY DEED RECORDED APRIL 11, 1942 IN BOOK 541 PAGE 79 OF OFFICIAL RECORDS OF RIVERSIDE COUNTY, CALIFORNIA.

PARCEL 2: THOSE PORTIONS OF LOTS 3 AND 4 OF EDGEMONT TRACT NO. 2, AS SHOWN BY MAP ON FILE IN BOOK 12 PAGE 19 OF MAPS, RECORDS OF RIVERSIDE COUNTY, CALIFORNIA, DESCRIBED AS FOLLOWS: BEGINNING AT A POINT ON THE EASTERLY LINE OF SAID LOT 4, 310 FEET SOUTH OF THE NORTHEAST CORNER THEREOF; THENCE SOUTH 89° 24' WEST PARALLEL WITH THE NORTHERLY LINE OF SAID LOT 4, 130 FEET; THENCE CONTINUING SOUTH 89° 24' WEST TO A POINT ON THE EASTERLY LINE OF LOT 5 OF SAID SUBDIVISION; THENCE SOUTH 20° 07' EAST ALONG THE EASTERLY LINES OF LOTS 5, 6 AND 7 OF SAID SUBDIVISION TO THE MOST SOUTHERLY CORNER OF SAID LOT 3; THENCE NORTH 69° 54' EAST ALONG THE SOUTHEASTERLY LINE OF SAID LOTS 4 AND 3 TO THE MOST SOUTHERLY CORNER OF THAT PARCEL OF LAND CONVEYED TO SUSANA LEMPERGER ET UX RECORDED MARCH 21, 1955 IN BOOK 1710 PAGE 255 OF OFFICIAL RECORDS OF RIVERSIDE COUNTY, CALIFORNIA; THENCE NORTH 0° 12' WEST AND PARALLEL WITH THE EAST LINE OF SAID LOT 4, 142.60 FEET; THENCE NORTH 89° 24' EAST AND PARALLEL WITH THE NORTHERLY LINE OF SAID LOT 4, 130 FEET; THENCE NORTHERLY ON THE WESTERLY LINE OF EDGEMONT STREET, 30 FEET TO THE POINT OF BEGINNING.

PARCEL 3: THAT PORTION OF LOT 4 OF EDGEMONT TRACT NO. 2, AS SHOWN BY MAP ON FILE IN BOOK 12 PAGE 19 OF MAPS, RECORDS OF RIVERSIDE COUNTY, CALIFORNIA, DESCRIBED AS FOLLOWS: BEGINNING AT A POINT ON THE EASTERLY LINE OF SAID LOT, 340 FEET SOUTH OF THE NORTHEAST CORNER THEREOF; THENCE 89° 24' WEST PARALLEL WITH THE NORTH LINE OF SAID LOT, 130 FEET; THENCE SOUTH 0° 12' EAST PARALLEL WITH THE EAST LINE OF SAID LOT, 142.60 FEET TO A POINT ON THE SOUTHEASTERLY LINE THEREOF; THENCE NORTH 69° 54' EAST, ALONG SAID SOUTHEASTERLY LINE, 138.27 FEET TO THE SOUTHWEST CORNER OF SAID LOT; THENCE NORTH ALONG THE EAST LINE OF SAID LOT, 96.45 FEET TO THE POINT OF BEGINNING. EXCEPTING THEREFROM ALL WATER AND WATER RIGHTS CONVEYED TO THE BOX SPRINGS MUTUAL WATER COMPANY BY DEED RECORDED IN BOOK 536 PAGE 470 OF DEEDS, RECORDS OF RIVERSIDE COUNTY, CALIFORNIA, SAID PROPERTY IS ALSO SHOWN ON RECORDS OF SURVEY IN BOOK 19 PAGE 4 OF RECORDS OF SURVEY, RECORDS OF RIVERSIDE COUNTY, CALIFORNIA.

PARCEL 4: LOT 7 OF EDGEMONT TRACT NO. 2, IN THE CITY OF MORENO VALLEY, COUNTY OF RIVERSIDE, STATE OF CALIFORNIA, AS SHOWN BY MAP ON FILE IN BOOK 12 PAGE 19 OF MAPS, RECORDS OF RIVERSIDE COUNTY, CALIFORNIA, EXCEPTING THEREFROM THE WESTERLY 72 FEET THEREOF FOR HIGHWAY PURPOSES CONVEYED BY ORDER OF THE SUPERIOR COURT OF THE STATE OF CALIFORNIA, IN AND FOR THE COUNTY OF RIVERSIDE, DATED DECEMBER 20, 1943, A COPY OF WHICH WAS RECORDED IN BOOK 610 PAGE 219 OF OFFICIAL RECORDS OF RIVERSIDE COUNTY, CALIFORNIA.

LOTS 8 AND 9 OF EDGEMONT TRACT NO. 2, AS SHOWN BY MAP ON FILE IN BOOK 12, PAGE 19 OF MAPS, RECORDS OF RIVERSIDE COUNTY, CALIFORNIA.

EXCEPTING THEREFROM THE WESTERLY 72 FEET CONVEYED TO THE STATE OF CALIFORNIA BY DEED RECORDED MAY 23, 1942 IN BOOK 533 PAGE 238 OF OFFICIAL RECORDS OF RIVERSIDE COUNTY, CALIFORNIA.

EXCEPTING THEREFROM ALL WATER AND WATER RIGHTS CONVEYED TO THE BOX SPRING MUTUAL WATER COMPANY, BY DEED RECORDED IN BOOK 536 PAGE 470 OF DEEDS, RECORDS OF RIVERSIDE COUNTY, CALIFORNIA.

PARCEL A: THOSE PORTIONS OF LOTS 3 AND 4 OF EDGEMONT TRACT NO. 2, AS SHOWN BY MAP ON FILE IN BOOK 12 PAGE 19 OF MAPS, RECORDS OF RIVERSIDE COUNTY, CALIFORNIA, DESCRIBED AS FOLLOWS: COMMENCING AT A POINT ON THE EASTERLY LINE OF SAID LOT 4, 310 FEET SOUTH OF THE NORTHEAST CORNER THEREOF; THENCE SOUTH 89 DEGREES 24 MINUTES WEST, PARALLEL WITH THE NORTHERLY LINE OF SAID LOT 4, 130 FEET TO THE TRUE POINT OF BEGINNING; THENCE CONTINUING SOUTH 89 DEGREES 24 MINUTES WEST TO A POINT ON THE MOST EASTERLY LINE OF LOT 5 OF SAID SUBDIVISION; THENCE NORTH 20 DEGREES 07 MINUTES WEST TO A POINT ON THE SOUTHEASTERLY LINE OF THAT CERTAIN PARCEL OF LAND CONVEYED TO CALIFORNIA ELECTRIC POWER COMPANY BY DEED RECORDED APRIL 8, 1952 AS INSTRUMENT NO. 14945, RIVERSIDE COUNTY RECORDS; THENCE NORTH 69 DEGREES 53 MINUTES EAST ON THE SOUTHEASTERLY LINE OF SAID PARCEL, 43 CONVEYED TO CALIFORNIA ELECTRIC POWER COMPANY TO THE SOUTHEASTERLY CORNER THEREOF; THENCE NORTH 0 DEGREES 12 MINUTES EAST ON THE EASTERLY LINE OF SAID PARCEL, TO THE NORTHEAST CORNER THEREOF; THENCE EASTERLY ON THE NORTHERLY LINE OF LOTS 3 AND 4, 121.5 FEET TO THE NORTHEAST CORNER OF THAT CERTAIN PARCEL OF LAND CONVEYED TO GEORGE H. ETTER, ET UX, BY DEED FILED FOR RECORD MAY 8, 1953 AS INSTRUMENT NO. 22773, RIVERSIDE COUNTY RECORDS; THENCE SOUTH 0 DEGREES 12 MINUTES EAST, 170 FEET TO THE SOUTHWEST CORNER OF THAT CERTAIN PARCEL OF LAND CONVEYED TO GEORGE H. ETTER, ET UX, BY DEED FILED JUNE 10, 1955 AS INSTRUMENT NO. 38132, RIVERSIDE COUNTY RECORDS; THENCE EAST ON THE SOUTHERLY LINE OF SAID PARCEL 65 FEET TO THE WESTERLY LINE OF PARCEL 1 OF THAT CERTAIN PROPERTY CONVEYED TO THOMAS LAMPERGER ET UX, BY DEED FILED FOR RECORD MARCH 31, 1955 AS INSTRUMENT NO. 18051, RIVERSIDE COUNTY RECORDS; THENCE SOUTHERLY ON THE SOUTHERLY LINE OF SAID PARCEL, 140 FEET TO THE SOUTHWEST CORNER THEREOF; THE TRUE POINT OF BEGINNING; EXCEPTING THEREFROM THAT PORTION DESCRIBED AS FOLLOWS: BEGINNING AT A POINT ON THE NORTHERLY LINE OF SAID LOT 3, WHICH BEARS NORTH 89 DEGREES 23 MINUTES EAST FROM THE NORTHEAST CORNER THEREOF, SAID POINT BEING THE NORTHEAST CORNER OF THAT CERTAIN PARCEL OF LAND CONVEYED TO CALIFORNIA ELECTRIC POWER COMPANY BY DEED RECORDED APRIL 8, 1952 AS INSTRUMENT NO. 14945; THENCE NORTH 89 DEGREES 23 MINUTES EAST, ALONG THE NORTHERLY LINE OF SAID LOTS 3 AND 4, 121.5 FEET; THENCE SOUTH 9 DEGREES 12 MINUTES EAST, 130 FEET; THENCE SOUTH 89 DEGREES 23 MINUTES WEST AND PARALLEL WITH THE NORTHERLY LINE OF SAID LOTS 3 AND 4, 121.5 FEET TO THE EASTERLY LINE OF SAID PARCEL CONVEYED TO THE CALIFORNIA ELECTRIC POWER COMPANY BY THE HEREIN ABOVE DESCRIBED DEED; THENCE NORTH 0 DEGREES 12 MINUTES WEST ALONG SAID EASTERLY LINE, 130 FEET TO THE POINT OF BEGINNING; EXCEPTING THEREFROM ALL WATER AND WATER RIGHTS CONVEYED TO THE BOX SPRINGS MUTUAL WATER COMPANY BY DEED RECORDED IN BOOK 536 PAGE 470 OF DEEDS, RIVERSIDE COUNTY RECORDS; PARCEL B: A NON-EXCLUSIVE RIGHT TO USE THE EAST 15 FEET OF THE FOLLOWING DESCRIBED PROPERTY AS AN ACCESS STRIP OF ROAD: THE WESTERLY PORTION OF LOT 3 OF EDGEMONT TRACT NO. 2, A SUBDIVISION IN BOOK 12 PAGE 19 OF MAPS, RIVERSIDE COUNTY RECORDS, DESCRIBED AS FOLLOWS: BEGINNING AT THE NORTHEAST CORNER OF SAID LOT 3, AND RUNNING THENCE SOUTH 35 DEGREES 36 MINUTES WEST, 399.25 FEET TO THE MOST WESTERLY CORNER OF SAID LOT 3; THENCE NORTH 69 DEGREES 53 MINUTES EAST ALONG THE SOUTHERLY LINE OF SAID LOT 3 AND ITS EXTENSION EASTERLY TO LOT 4; THENCE SOUTH 9 DEGREES 12 MINUTES EAST, 130 FEET, MORE OR LESS, TO A POINT ON THE NORTH LINE OF SAID LOT 3; THENCE SOUTH 89 DEGREES 23 MINUTES WEST 25 FEET TO THE POINT OF BEGINNING. PARCEL C: A NON-EXCLUSIVE EASEMENT FOR ROAD PURPOSES AND ALL PUBLIC UTILITY PURPOSES OVER THE FOLLOWING DESCRIBED PROPERTY: THOSE PORTIONS OF LOTS 3 AND 4 OF EDGEMONT TRACT NO. 2 AS SHOWN BY MAP ON FILE IN BOOK 12 PAGE 19 OF MAPS, RIVERSIDE COUNTY RECORDS, DESCRIBED AS FOLLOWS: BEGINNING AT A POINT ON THE EASTERLY LINE OF SAID LOT 4, 310 FEET SOUTH OF THE NORTHEAST CORNER THEREOF; THENCE SOUTH 89 DEGREES 24 MINUTES WEST PARALLEL WITH THE NORTHERLY LINE OF LOTS 3 AND 4, 210 FEET TO A POINT; THENCE SOUTH 30 FEET TO A POINT MEASURED AT RIGHT ANGLES FROM THE ABOVE DESCRIBED EAST AND WEST COURSE; THENCE NORTH 89 DEGREES 24 MINUTES EAST 30 FEET SOUTH OF AND PARALLEL TO THE ABOVE DESCRIBED EAST AND WEST COURSE TO THE EAST LINE OF SAID LOT 4; THENCE NORTH 30 FEET TO THE POINT OF BEGINNING.

EASEMENTS

- 1. COVENANTS, CONDITIONS, RESTRICTIONS AND EASEMENTS IN THE DOCUMENT RECORDED MARCH 16, 1925 IN BOOK 633 OF DEEDS, PAGE 63, WHICH PROVIDE THAT A VIOLATION THEREOF SHALL NOT DEFEAT OR RENDER INVALID THE LIEN OF ANY FIRST MORTGAGE OR DEED OF TRUST MADE IN GOOD FAITH AND FOR VALUE, BUT DELETING ANY COVENANT, CONDITION, OR RESTRICTION, IF ANY, INDICATING A PREFERENCE, LIMITATION, OR DISCRIMINATION BASED ON RACE, COLOR, RELIGION, SEX, GENDER, GENDER IDENTITY, GENDER EXPRESSION, SEXUAL ORIENTATION, MARITAL STATUS, DISABILITY, HANDICAP, VETERAN OR MILITARY STATUS, GENETIC INFORMATION, NATIONAL ORIGIN, SOURCE OF INCOME AS DEFINED IN SUBDIVISION (P) OF SECTION 12965, OR ANCESTRY, TO THE EXTENT THAT SUCH COVENANTS, CONDITIONS OR RESTRICTIONS VIOLATE APPLICABLE STATE OR FEDERAL LAWS. LAWFUL RESTRICTIONS UNDER STATE AND FEDERAL LAW ON THE AGE OF OCCUPANTS IN SENIOR HOUSING OR HOUSING FOR OLDER PERSONS SHALL NOT BE CONSTRUED AS RESTRICTIONS BASED ON FAMILIAL STATUS.
- 2. AN EASEMENT FOR POLE LINES, CONDUITS AND INCIDENTAL PURPOSES, RECORDED DECEMBER 20, 1926 IN BOOK 698 OF DEEDS, PAGE 298. IN FAVOR OF: SOUTHERN SIERRAS POWER COMPANY, A CORPORATION THE LOCATION OF THE EASEMENT CANNOT BE DETERMINED FROM RECORD INFORMATION.
- 3. AN EASEMENT FOR POLE LINES, CONDUITS AND INCIDENTAL PURPOSES, RECORDED DECEMBER 21, 1926 IN BOOK 698 OF DEEDS, PAGE 313. IN FAVOR OF: SOUTHERN SIERRAS POWER COMPANY THE EASEMENT IS ALONG THE PROPERTY LINE.
- 4. AN EASEMENT FOR EITHER OR BOTH POLE LINES, CONDUITS OR UNDERGROUND FACILITIES AND INCIDENTAL PURPOSES, RECORDED SEPTEMBER 14, 1928 IN BOOK 779 OF DEEDS, PAGE 406. IN FAVOR OF: SOUTHERN SIERRAS POWER COMPANY AFFECTS AS DESCRIBED THEREIN.
- 5. AN EASEMENT FOR POLE LINES, CONDUITS AND INCIDENTAL PURPOSES, RECORDED DECEMBER 04, 1931 AS BOOK 59, PAGE 67 OF OFFICIAL RECORDS. IN FAVOR OF: SOUTHERN SIERRAS POWER COMPANY THE LOCATION OF THE EASEMENT CANNOT BE DETERMINED FROM RECORD INFORMATION.
- 6. COVENANTS, CONDITIONS, RESTRICTIONS AND EASEMENTS IN THE DOCUMENT RECORDED FEBRUARY 02, 1934 AS BOOK 152, PAGE 556 OF OFFICIAL RECORDS, WHICH PROVIDE THAT A VIOLATION THEREOF SHALL NOT DEFEAT OR RENDER INVALID THE LIEN OF ANY FIRST MORTGAGE OR DEED OF TRUST MADE IN GOOD FAITH AND FOR VALUE, BUT DELETING ANY COVENANT, CONDITION, OR RESTRICTION, IF ANY, INDICATING A PREFERENCE, LIMITATION, OR DISCRIMINATION BASED ON RACE, COLOR, RELIGION, SEX, GENDER, GENDER IDENTITY, GENDER EXPRESSION, SEXUAL ORIENTATION, MARITAL STATUS, DISABILITY, HANDICAP, VETERAN OR MILITARY STATUS, GENETIC INFORMATION, NATIONAL ORIGIN, SOURCE OF INCOME AS DEFINED IN SUBDIVISION (P) OF SECTION 12965, OR ANCESTRY, TO THE EXTENT THAT SUCH COVENANTS, CONDITIONS OR RESTRICTIONS VIOLATE APPLICABLE STATE OR FEDERAL LAWS. LAWFUL RESTRICTIONS UNDER STATE AND FEDERAL LAW ON THE AGE OF OCCUPANTS IN SENIOR HOUSING OR HOUSING FOR OLDER PERSONS SHALL NOT BE CONSTRUED AS RESTRICTIONS BASED ON FAMILIAL STATUS. EASEMENT CAN NOT BE PLOTTED FROM RECORD INFORMATION (AFFECTS LOT 8).
- 7. AN EASEMENT FOR PUBLIC UTILITIES AND INCIDENTAL PURPOSES, RECORDED APRIL 13, 1953 AS INSTRUMENT NO. 17925 OF OFFICIAL RECORDS. IN FAVOR OF: SOUTHERN CALIFORNIA GAS COMPANY AFFECTS AS DESCRIBED THEREIN.
- 8. AN EASEMENT FOR ROAD PURPOSES AND PUBLIC UTILITIES AND INCIDENTAL PURPOSES, RECORDED OCTOBER 18, 1963 AS INSTRUMENT NO. 110469 OF OFFICIAL RECORDS. IN FAVOR OF: CATHERINE E. HARRIS AFFECTS AS DESCRIBED THEREIN.
- 9. AN EASEMENT FOR POLE LINES, CONDUITS AND INCIDENTAL PURPOSES, RECORDED DECEMBER 20, 1926 IN BOOK 698 OF DEEDS, PAGE 298 IN FAVOR OF: SOUTHERN SIERRAS POWER COMPANY THE LOCATION OF THE EASEMENT CANNOT BE DETERMINED FROM RECORD INFORMATION (AFFECTS LOT 9).
- 10. AN EASEMENT FOR POLE LINES, CONDUITS AND INCIDENTAL PURPOSES, RECORDED DECEMBER 21, 1926 IN BOOK 698 OF DEEDS, PAGE 313. IN FAVOR OF: SOUTHERN SIERRAS POWER COMPANY THE EASEMENT IS ALONG PROPERTY LINES (AFFECTS LOT 9).
- 11. COVENANTS, CONDITIONS, RESTRICTIONS AND EASEMENTS IN THE DOCUMENT RECORDED JUNE 27, 1928 IN BOOK 771 OF DEEDS, PAGE 149, WHICH PROVIDE THAT A VIOLATION THEREOF SHALL NOT DEFEAT OR RENDER INVALID THE LIEN OF ANY FIRST MORTGAGE OR DEED OF TRUST MADE IN GOOD FAITH AND FOR VALUE, BUT DELETING ANY COVENANT, CONDITION, OR RESTRICTION, IF ANY, INDICATING A PREFERENCE, LIMITATION OR DISCRIMINATION BASED ON RACE, COLOR, RELIGION, SEX, GENDER, GENDER IDENTITY, GENDER EXPRESSION, SEXUAL ORIENTATION, FAMILIAL STATUS, MARITAL STATUS, DISABILITY, HANDICAP, VETERAN OR MILITARY STATUS, GENETIC INFORMATION, NATIONAL ORIGIN, SOURCE OF INCOME AS DEFINED IN SUBDIVISION (P) OF SECTION 12965, OR ANCESTRY, TO THE EXTENT THAT SUCH COVENANTS, CONDITIONS OR RESTRICTIONS VIOLATE APPLICABLE STATE OR FEDERAL LAWS. LAWFUL RESTRICTIONS UNDER STATE AND FEDERAL LAW ON THE AGE OF OCCUPANTS IN SENIOR HOUSING OR HOUSING FOR OLDER PERSONS SHALL NOT BE CONSTRUED AS RESTRICTIONS BASED ON FAMILIAL STATUS. EASEMENT CAN NOT BE PLOTTED FROM RECORD INFORMATION (AFFECTS LOT 8).
- 12. AN EASEMENT FOR POLE LINES, CONDUITS AND INCIDENTAL PURPOSES, RECORDED SEPTEMBER 14, 1928 IN BOOK 779 OF DEEDS, PAGE 406. IN FAVOR OF: SOUTHERN SIERRAS POWER COMPANY.
- 13. AN EASEMENT FOR POLE LINES, CONDUITS AND INCIDENTAL PURPOSES, RECORDED DECEMBER 04, 1931 AS BOOK 59, PAGE 67 OF OFFICIAL RECORDS. IN FAVOR OF: SOUTHERN SIERRAS POWER COMPANY THE LOCATION OF THE EASEMENT CANNOT BE DETERMINED FROM RECORD INFORMATION.
- 14. AN EASEMENT FOR EITHER OR BOTH POLE LINES, CONDUITS OR UNDERGROUND FACILITIES AND INCIDENTAL PURPOSES, RECORDED DECEMBER 18, 1948 AS BOOK 1035, PAGE 588 OF OFFICIAL RECORDS. IN FAVOR OF: CALIFORNIA ELECTRIC POWER COMPANY (AFFECTS LOT 8).
- 15. AN EASEMENT FOR EITHER OR BOTH POLE LINES, CONDUITS OR UNDERGROUND FACILITIES AND INCIDENTAL PURPOSES, RECORDED JANUARY 28, 1949 AS BOOK 1047, PAGE 76 OF OFFICIAL RECORDS. IN FAVOR OF: CALIFORNIA ELECTRIC POWER COMPANY (AFFECTS LOT 9).
- 16. AN EASEMENT FOR UTILITIES AND INCIDENTAL PURPOSES, RECORDED FEBRUARY 02, 1934 IN BOOK 152 OF DEEDS, PAGE 556. IN FAVOR OF FIRST TRUST AND SAVINGS BANK OF PASADENA AFFECTS THE LOCATION OF THE EASEMENT CANNOT BE DETERMINED FROM RECORD INFORMATION.
- 17. AN EASEMENT FOR POLE LINES, CONDUITS AND INCIDENTAL PURPOSES, RECORDED DECEMBER 21, 1926 IN BOOK 698 OF DEEDS, PAGE 313. IN FAVOR OF SOUTHERN SIERRAS POWER COMPANY EASEMENT IS ALONG PROPERTY LINES.
- 18. AN EASEMENT FOR POLE LINES, CONDUITS AND INCIDENTAL PURPOSES, RECORDED FEBRUARY 21, 1926 IN BOOK 698 OF DEEDS, PAGE 313. IN FAVOR OF: SOUTHERN SIERRAS POWER COMPANY THE EASEMENT IS ALONG PROPERTY LINES.
- 19. AN EASEMENT FOR POLE LINES AND INCIDENTAL PURPOSES, RECORDED SEPTEMBER 24, 1928 IN BOOK 779 OF DEEDS, PAGE 406. IN FAVOR OF: SOUTHERN SIERRAS POWER COMPANY.
- 20. COVENANTS, CONDITIONS, RESTRICTIONS AND EASEMENTS IN THE DOCUMENT RECORDED FEBRUARY 02, 1934 AS BOOK 152, PAGE 556 OF OFFICIAL RECORDS, BUT DELETING ANY COVENANT, CONDITION OR RESTRICTION INDICATING A PREFERENCE, LIMITATION OR DISCRIMINATION BASED ON RACE, COLOR, RELIGION, SEX, HANDICAP, FAMILIAL STATUS, NATIONAL ORIGIN, SEXUAL ORIENTATION, MARITAL STATUS, ANCESTRY, SOURCE OF INCOME OR DISABILITY, TO THE EXTENT THAT SUCH COVENANTS, CONDITIONS OR RESTRICTIONS VIOLATE TITLE 42, SECTION 3604(C), OF THE UNITED STATES CODES. LAWFUL RESTRICTIONS UNDER STATE AND FEDERAL LAW ON THE AGE OF OCCUPANTS IN SENIOR HOUSING OR HOUSING FOR OLDER PERSONS SHALL NOT BE CONSTRUED AS RESTRICTIONS BASED ON FAMILIAL STATUS. EASEMENT CAN NOT BE PLOTTED FROM RECORD INFORMATION.
- 21. AN EASEMENT FOR PIPELINE AND INCIDENTAL PURPOSES, RECORDED APRIL 13, 1953 AS BOOK 1460, PAGE 531 OF OFFICIAL RECORDS. IN FAVOR OF: SOUTHERN CALIFORNIA GAS COMPANY AFFECTS AS DESCRIBED THEREIN.

UTILITY NOTIFICATION

FRONTIER COMMUNICATIONS
9 S. 4TH STREET
REDLAND, CA 92373
PHONE: (909) 748-6676
CHARTER COMMUNICATIONS
7337 CENTRAL AVENUE
RIVERSIDE, CA 92504
PHONE: (951) 406-1666
ELECTRIC
MORENO VALLEY UTILITY
14331 FREDERICK STREET, STE. 2
MORENO VALLEY, CA 92553
PHONE: (951) 413-3500
SOUTHERN CALIFORNIA GAS COMPANY
1981 WEST LUGONIA AVENUE
REDLAND, CA 92373
PHONE: (909) 335-7550
SOUTHERN CALIFORNIA EDISON
28100 WENIFEE ROAD
ROMOLAND, CA 92585
PHONE: (951) 928-8334
EDGEMONT COMMUNITY SERVICES DISTRICT
5055 CANYON CREST DR.
RIVERSIDE, CA 92507
PHONE: (951) 784-2632
BOX SPRINGS MUTUAL WATER COMPANY
21740 CRACAEA AVE.
MORENO VALLEY, CA 92533
(951) 653-6419

LEGEND

- 1:30 PROPOSED CONTOUR
1:30 EXISTING CONTOUR
2:30X PROPOSED GRADE
E CENTERLINE
FH FIRE HYDRANT
R/W RIGHT OF WAY
P.L. PROPERTY LINE
PB UTILITY PULL BOX/AULT
SMH SEWER MANHOLE
GB GRADE BREAK
TC TOP OF CURB
VC TOP OF GRATE
VC VALVE COVER
FS FINISH SURFACE
FL FLOWLINE
XX.XX PROPOSED ELEVATION
XX.XX EXISTING ELEVATION
PP PROPOSED STREET LIGHT
PP PROPOSED PERIMETER FENCE
PP PROPOSED TRUCK DOCK
PP PROPOSED AC PAVING
PP PROPOSED PCC PAVING
PP PROPOSED BIOSWALE

GENERAL NOTES

- 1. ASSESSOR'S PARCEL NUMBER: 263-190-012, 014-019, 036
2. EXISTING GROSS AREA: 345,886 SF = 7.94 AC
3. EXISTING NET USABLE AREA: 299,713 SF = 6.88 AC
4. PROPOSED NET USABLE AREA: 307,433 SF = 7.06 AC
5. PROPOSED STREET VACATION AREA: 7,720 SF = 0.18 AC
6. EXISTING ZONE DESIGNATION: INDUSTRIAL/BUSINESS PARK
7. PROPOSED ZONE DESIGNATION: INDUSTRIAL/BUSINESS PARK
8. EXISTING LAND USE: VACANT
9. PROPOSED LAND USE: WAREHOUSE / OFFICE
10. PROJECT SITE IS LOCATED WITHIN ZONE "M" SHADOD - AREAS OF 0.28 ANNUAL CHANCE FLOOD; AREAS OF 18 ANNUAL CHANCE FLOOD WITH AVERAGE DEPTHS OF LESS THAN 1 FOOT OR WITH DRAINAGE AREAS LESS THAN 1 SQUARE MILE, AND AREAS PROTECTED BY LEVEES FROM 18 ANNUAL CHANCE FLOOD AS PER FLOOD INSURANCE RATE MAP COMMUNITY PANEL NUMBER 08065007465, DATED AUGUST 28, 2008
11. CONTIGUOUS OWNERSHIP
12. ALL EXISTING UTILITY POLES ON SITE WILL BE REMOVED/UNDERGROUND
13. EXISTING UTILITIES IN CONFLICT WILL BE RELOCATED
14. T.M. 38325

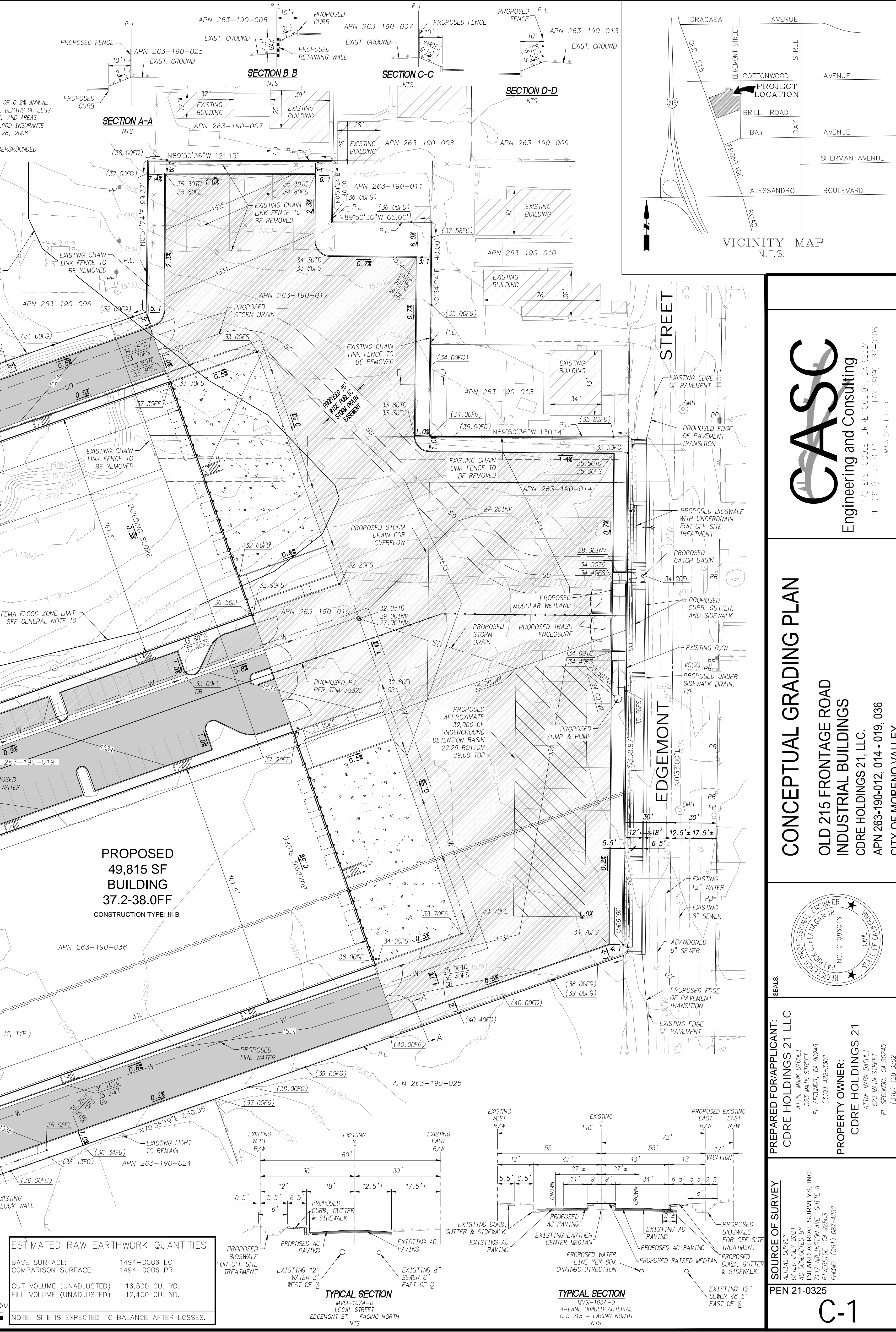

PROPOSED 49,815 SF BUILDING 36.5-37.3FF CONSTRUCTION TYPE III-B

PROPOSED 49,815 SF BUILDING 37.2-38.0FF CONSTRUCTION TYPE III-B

ESTIMATED RAW EARTHWORK QUANTITIES
BASE SURFACE: 1494-0006 EG
COMPARISON SURFACE: 1494-0006 PR
CUT VOLUME (UNADJUSTED): 16,500 CU. YD.
FILL VOLUME (UNADJUSTED): 12,400 CU. YD.
NOTE: SITE IS EXPECTED TO BALANCE AFTER LOSSES.

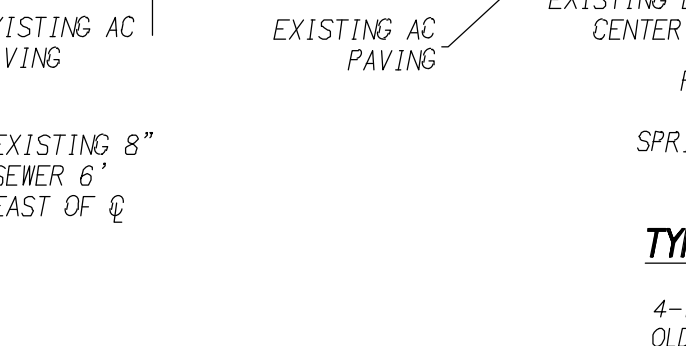
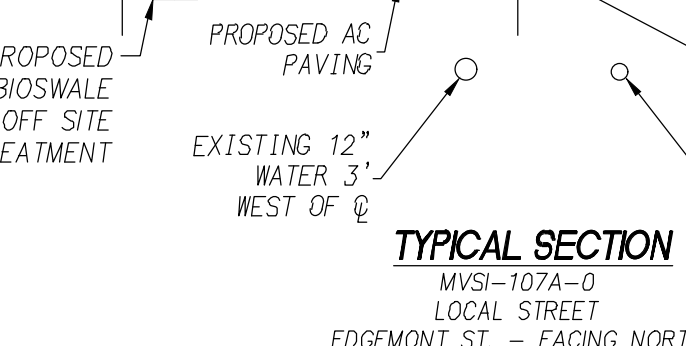

CASC Engineering and Consulting
1719 E. COLLEGE AVE. SUITE 100, PASADENA, CA 92369
TEL: (951) 345-4477 FAX: (951) 345-4478
WWW.CASC-CA.COM

CONCEPTUAL GRADING PLAN
OLD 215 FRONTAGE ROAD INDUSTRIAL BUILDINGS
CORE HOLDINGS 21, LLC.
APN 263-190-012, 014 - 019, 036
CITY OF MORENO VALLEY

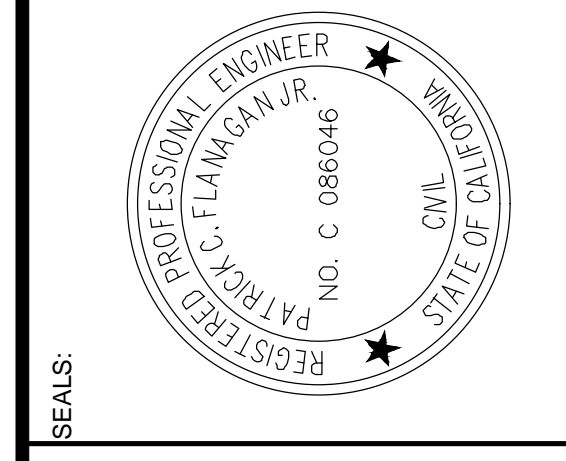

PREPARED FOR/APPLICANT: CORE HOLDINGS 21 LLC
ATTN: MARK BAGOLI
523 MAIN STREET
EL SEGUIO, CA 93745
(510) 428-3302
PROPERTY OWNER: CORE HOLDINGS 21
ATTN: MARK BAGOLI
523 MAIN STREET
EL SEGUIO, CA 93745
(510) 428-3302

SOURCE OF SURVEY: METAL SURVEY
DATE: JULY 2021
INLAND AERIAL SURVEYS, INC.
7177 ARLINGTON AVE. SUITE A
RIVERSIDE, CA 92503
PHONE: (951) 697-4252
DATE OF PLAN: March 17, 2022
PEN 21-0325

Appendix 3: Soils Information

Geotechnical Study and Other Infiltration Testing Data

**PRELIMINARY GEOTECHNICAL AND
INFILTRATION FEASIBILITY INVESTIGATION
PROPOSED INDUSTRIAL DEVELOPMENT
APNs 263-190-012, -014, -015, -016,
-017, -018, -019 AND -036
MORENO VALLEY, CALIFORNIA**

**PROJECT NO. 23756.1
SEPTEMBER 21, 2021**

Prepared For:

Compass Danbe Real Estate Partners LLC
523 Main Street
El Segundo, California 90245

Attention: Mr. Mark Bachli

September 21, 2021

Compass Danbe Real Estate Partners LLC
8151 Auto Drive
Riverside, California 92504

Project No. 23756.1

Attention: Mr. Mark Bachli

Subject: Preliminary Geotechnical and Infiltration Feasibility Investigation, Proposed Industrial Development, APNs 263-190-012, -014, -015, -016, -017, -018, -019, and -036, Moreno Valley, California.

LOR Geotechnical Group, Inc., is pleased to present this report of our geotechnical investigation for the subject project. In summary, it is our opinion that the proposed development is feasible from a geotechnical perspective, provided the recommendations presented in the attached report are incorporated into design and construction. However, the contents of this summary should not be solely relied upon.

To provide adequate support for the proposed structure, we recommend that a compacted fill mat be constructed beneath footings and slabs. The compacted fill mat will provide a dense, high-strength soil layer to uniformly distribute the anticipated foundation loads over the underlying soils. Any undocumented fill material and any loose alluvial materials should be removed from structural areas and areas to receive engineered compacted fills. The data developed during this investigation indicates that removals on the order of approximately 2 to 5 feet will be required from currently planned development areas. The given removal depths are preliminary and the actual depths of the removals should be determined during the grading operation by observation and/or in-place density testing.

Very low expansion potential, good R-value quality, and negligible soluble sulfate content generally characterize the onsite materials tested. Near completion and/or at the completion of site grading, additional foundation and subgrade soils should be tested as necessary, to verify their expansion potential, soluble sulfate content, and R-value quality.

Non-conductive infiltration rates were obtained for the soils tested.

LOR Geotechnical Group, Inc.

TABLE OF CONTENTS

	<u>Page No.</u>
INTRODUCTION.	1
PROJECT CONSIDERATIONS.	1
AERIAL PHOTO ANALYSIS.	2
EXISTING SITE CONDITIONS.	3
SUBSURFACE FIELD INVESTIGATION.	3
LABORATORY TESTING PROGRAM.	4
GEOLOGIC CONDITIONS.	4
Regional Geologic Setting.	4
Site Geologic Conditions.	5
Groundwater Hydrology.	5
Mass Movement.	6
Faulting.	6
Historical Seismicity.	7
Secondary Seismic Hazards.	8
Liquefaction.	8
Seiches/Tsunamis.	8
Flooding (Water Storage Facility Failure).	8
Seismically-Induced Landsliding.	8
Rockfalls.	8
Seismically-Induced Settlement.	8
SOILS AND SEISMIC DESIGN CRITERIA (California Building Code 2019).	9
Site Classification.	9
CBC Earthquake Deign Summary.	9
INFILTRATION TESTING AND TEST RESULTS.	9
Infiltration Testing.	9

TABLE OF CONTENTS

	<u>Page No.</u>
CONCLUSIONS.....	10
Foundation Support.....	11
Soil Expansiveness.....	11
Sulfate Protection.....	11
Infiltration.....	11
Geologic Mitigations.....	12
Seismicity.....	12
RECOMMENDATIONS.....	12
Geologic Recommendations.....	12
General Site Grading.....	12
Initial Site Preparation.....	13
Preparation of Fill Areas.....	14
Engineered Compacted Fill.....	14
Preparation of Foundation Areas.....	14
Short-Term Excavations.....	14
Slope Construction.....	15
Slope Protection.....	15
Soil Expansiveness.....	15
Foundation Design.....	16
Settlement.....	16
Building Area Slab-On-Grade.....	17
Exterior Flatwork.....	17
Wall Pressures.....	17
Preliminary Pavement Design.....	18
Infiltration.....	20
Construction Monitoring.....	20
LIMITATIONS.....	21
TIME LIMITATIONS.....	21
CLOSURE.....	22
REFERENCES.....	23

TABLE OF CONTENTS

Page No./Enclosures

APPENDICES

Appendix A

Index Map.....	A-1
Site Plan.....	A-2
Infiltration Location Map.....	A-3
Regional Geologic Map.	A-4
Historical Seismicity Maps.	A-5 and A-6

Appendix B

Field Investigation Program.....	B
Boring Log Legend.....	B-i
Soil Classification Chart.....	B-ii
Boring Logs.	B-1 through B-5

Appendix C

Laboratory Testing Program.....	C
Laboratory Test Results.....	C-1

Appendix D

Seismic Design Spectra.....	D
-----------------------------	---

Appendix E

Infiltration Test Results.....	E-1 and E-2
--------------------------------	-------------

INTRODUCTION

During September of 2021, a Preliminary Geotechnical and Infiltration Feasibility Investigation was performed by LOR Geotechnical Group, Inc., for the proposed industrial development of Assessor's Parcel Numbers (APNs) 263-190-012, -014, -015, -016, -017, -018, -019, and -036, Moreno Valley, California. The purpose of this investigation was to provide a technical evaluation of the geologic setting of the site and to provide geotechnical design recommendations for the proposed development. The scope of our services included:

- Review of available geotechnical literature, reports, maps, and agency information pertinent to the study area;
- Interpretation of aerial photographs of the site and surrounding regions dated 1966 through 2020;
- Geologic field reconnaissance mapping to verify the areal distribution of earth units and significance of surficial features as compiled from documents, literature, and reports reviewed;
- A subsurface field investigation to determine the physical soil conditions pertinent to the proposed development;
- Percolation testing via the borehole test method;
- Laboratory testing of selected soil samples obtained during the field investigation;
- Development of geotechnical recommendations for site grading and foundation design; and
- Preparation of this report summarizing our findings, and providing conclusions and recommendations for site development.

The approximate location of the site is shown on the attached Index Map, Enclosure A-1, within Appendix A.

PROJECT CONSIDERATIONS

To orient our investigation at the site, a Site Plan prepared by HPA Architecture, dated August 12, 2021, was furnished for our use. The current site conditions and proposed building configuration and associated driveways, parking, and landscape areas were

indicated on this plan. The Site Plan was utilized as a base map for our field investigation and is presented as Enclosure A-2, within Appendix A.

As noted on the site plan, development of the site will include a 84,388 ± square foot industrial type structure, with the remainder of the property used for driveways, parking, and landscape areas. The building is anticipated to be of concrete, masonry or similar type construction and light to moderate foundation loads are anticipated with this structure.

An infiltration location exhibit was provided for our use and was prepared by CASC Engineering & Consulting, dated August 18, 2021. This plan shows the current site conditions and the desired depths and locations of the requested infiltration testing. A copy of this plan is provided as Enclosure A-3 within Appendix A.

Grading plans have not yet been developed. However, based on the current topography of the site and adjacent areas, minor cuts and fills are anticipated to create level surfaces for the proposed development.

AERIAL PHOTO ANALYSIS

The aerial photographs reviewed consisted of vertical aerial photograph images of varying scales. We reviewed imagery available from Google Earth Pro (2021) computer software and from online Historic Aerials (2021).

To summarize briefly, the site was used for residential purposes since prior to 1948, through the early 1990's, the earliest photograph available. Numerous residences were present across the site at that time, primarily within the northwest, south, and northeast portions. Up to approximately 18 small residences were present. In 1966, a slightly larger, perhaps commercial structure was present along Old I-215. By 1994, all of the structures were no longer present. Some fill materials were placed in the far northwest corner in 2009. A roughly 'L' shaped area along Edgemont Street appears to have been created through the removal of soil (borrow) to a depth of approximately 5 feet. The previously noted fill in the far northwest corner has since been extended eastward approximately 150 feet. End dumped fill piles were present along Edgemont Street in 2018. No evidence for the presence of faults traversing the site area or mass movement features was noted during our review of the photographs covering the site and nearby vicinity.

EXISTING SITE CONDITIONS

The approximate 7-acre site is vacant land located between Edgemont Street on the east and Old I-215 on the west, approximately 300 feet south of Cottonwood Avenue in the northwest portion of the city of Moreno Valley. The northern portion of the site was being used as a storage yard for vehicles. End dumped piles of fill were present along Edgemont Street in the eastern portion of the site, along the east side of Old I-215 in the western portion of the site, and in the center portion of the site. Some landscape and concrete debris was intermixed with these end dumped piles. The remainder of the site was vacant, contained very sparse weeds and portions of the site were recently disced. Power lines were present along the east side of Old I-215 and another parallel set was present approximately 100 feet east of Old I-215. Topographically, the site is planar with a gentle fall to the north.

Old I-215, an asphalt-paved roadway, borders the site to the west, with commercial/industrial properties beyond. Edgemont Street, an asphalt-paved roadway, borders the site on the east with residential properties beyond. A commercial property and vacant land lie adjacent to the site on the south. A small earthen drainage channel and single family residences lie north of the site.

SUBSURFACE FIELD INVESTIGATION

Our subsurface field exploration program was conducted on September 7, 2021. The work consisted of advancing a total of 5 exploratory borings using a truck-mounted drill rig equipped with 8-inch diameter hollow stem augers. The approximate locations of our exploratory borings are presented on Enclosures A-2 and A-3, within Appendix A.

The subsurface conditions encountered in the exploratory borings were logged by a geologist from this firm. The borings were drilled to maximum depths of 21.5 to 51.5 feet below the existing ground surface. Relatively undisturbed and bulk samples were obtained at a maximum depth interval of 5 feet, and returned to our geotechnical laboratory in sealed containers for further testing and evaluation.

A detailed description of the subsurface field exploration program and the boring logs is presented in Appendix B.

LABORATORY TESTING PROGRAM

Selected soil samples obtained during the field investigation were subjected to geotechnical laboratory testing to evaluate their physical and engineering properties. Laboratory testing included in-place moisture content and dry density, laboratory compaction characteristics, direct shear, expansion index, sieve analysis, sand equivalent, R-value, expansion index, and soluble sulfate content. A detailed description of the geotechnical laboratory testing program and the test results are presented in Appendix C.

GEOLOGIC CONDITIONS

Regional Geologic Setting

The site is located within the northwestern portion of Moreno Valley which in turn lies within the northern end of the Perris Valley just south of the base of the Box Springs Mountains. This area is located on the Perris block within the northern Peninsular Ranges geologic province of southern California. While the Perris block is considered to be a relatively stable structural block, it is bounded by active faults. These include the Elsinore fault zone on the southwest, the San Jacinto fault zone on the east and the Cucamonga fault zone on the north. The Perris block is underlain predominately by a very large mass of crystalline igneous rocks of Cretaceous age and older metasedimentary and metavolcanic rocks.

The Perris block has a series of erosional surfaces, marked by low topographic relief and capped with unconsolidated alluvial sediments stripped from the surrounding highlands, such as the Box Springs Mountains. The Perris Valley is a long and narrow alluviated valley which drains to the southeast. This region of and around the site was mapped by the California Division of Mines and Geology as being underlain by deposits of slightly to well consolidated to indurated older alluvium (Morton and Matti, 2001).

The nearest known active fault zone is the San Jacinto fault zone located approximately 11.0 kilometers (7.0 miles) to the northeast. Other major faults within the region include the San Andreas fault zone located approximately 25 kilometers (15.5 miles) to the northeast, and the Elsinore fault zone located approximately 25.5 kilometers (16.0 miles) to the southwest.

The site and the regional geologic setting are shown on Enclosure A-3 within Appendix A.

Site Geologic Conditions

Fill: Fill materials were encountered within all of our exploratory borings to depths of approximately 1 to 5 feet. These materials are believed to be associated with past site development and current and past weed abatement (discing) practices at the site. As encountered, the fill materials were comprised of silty sand which was predominantly brown, dry, and in a loose state. Some asphalt grindings, concrete debris, and plastic was encountered within the fill. Locally, deeper fills are anticipated primarily associated with the past development in the various areas of the site noted during our aerial photograph review. Expansion index testing of these materials indicates a very low expansion potential.

Older Alluvium: Older alluvial materials were encountered underlying the fill materials described above within all of our exploratory borings to the maximum depths explored. These units were noted to mainly consist of silty sand with a minor unit of well graded sand with silt. These materials were typically red brown in color, damp to moist, and micaceous. The older alluvial materials were in a relatively medium dense to very dense state upon first encounter, becoming dense to very dense quickly with depth based on our equivalent Standard Penetration Test (SPT) data and in-place density testing.

A detailed description of the subsurface soil conditions as encountered within our exploratory borings, is presented on the Boring Logs within Appendix B.

Groundwater Hydrology

Groundwater was encountered within four of our exploratory borings, B-1, B-2, B-3, and B-5, at depths of approximately 18, 34, 19, and 18 feet below the existing ground surface, respectively.

In order to estimate the approximate depth to groundwater in the site area, a search was conducted for local groundwater (well) level measurements within the Cooperative Well Measuring Program, Spring 2021 (Watermaster Support Services et al., 2021). This database contains depth to groundwater measurements dating back to 1993. The closest well found is owned and/or operated by Box Springs Mutual Water Company, and are listed as the Local Well ID Box Springs Mutual #17, located approximately 0.7 kilometers (0.4 miles) to the northeast of the site. In this well, designated by the State Well Numbering System as 03S/04W-10A, groundwater was last measured at a depth of approximately 17 feet below the ground surface in March of 2021. Groundwater has risen over the time period for which data was available from a depth of approximately 116 feet in March of 1993 to a depth of approximately 17 feet in the latest measurement in the database.

We conducted a search of the water well database information provided in the California Department of Water Resources (CDWR) Water Library Data website (CDWR, 2021). This search did not indicate any wells nearby the project site.

Based on the information above, groundwater at the site appears to be at depths on the order of 17 to 19 feet below the ground surface.

Mass Movement

The site lies on a relatively flat surface. The occurrence of mass movement failures such as landslides, rockfalls, or debris flows within such areas is generally not considered common, and no evidence of mass movement was observed on the site.

Faulting

No active or potentially active faults are known to exist at the subject site. In addition, the subject site does not lie within a current State of California Earthquake Fault Zone (Hart and Bryant, 2003) nor does the site lie within a County of Riverside fault zone (CRTLMA, 2021). No evidence of faulting projecting into or crossing the site was noted during our aerial photograph review or our review of published geologic maps.

As previously mentioned, the closest known active earthquake fault with a documented location is the San Jacinto fault located approximately 11.0 kilometers (7.0 miles) to the northeast. In addition, other relatively close active faults include the San Andreas fault located approximately 25.0 kilometers (15.5 miles) to the northeast, and the Elsinore fault located approximately 25.5 kilometers (16.0 miles) to the southwest.

The San Jacinto fault zone is a sub-parallel branch of the San Andreas fault zone, extending from the northwestern San Bernardino area, southward into the El Centro region. This fault has been active in recent times with several large magnitude events. It is believed that the San Jacinto fault is capable of producing an earthquake magnitude on the order of 6.5 or larger.

The San Andreas fault is considered to be the major tectonic feature of California, separating the Pacific Plate and the North American Plate. While estimates vary, the San Andreas fault is generally thought to have an average slip rate on the order of 24mm/yr and capable of generating large magnitude events on the order of 7.5.

The Elsinore fault zone is one of the largest in southern California. At its northern end it splays into two segments and at its southern end it is cut by the Yuba Wells fault. The primary sense of slip along the Elsinore fault is right lateral strike-slip. It is believed that the Elsinore fault zone is capable of producing an earthquake magnitude on the order of 6.5 to 7.5.

Current standards of practice included a discussion of all potential earthquake sources within a 100 kilometer (62 mile) radius. However, while there are other large earthquake faults within a 100 kilometer (62-mile) radius of the site, none of these are considered as relevant to the site as the faults described above, due to their closer distance and larger anticipated magnitudes.

Historical Seismicity

In order to obtain a general perspective of the historical seismicity of the site and surrounding region a search was conducted for seismic events at and around the area within various radii. This search was conducted utilizing the historical seismic search website of the U.S.G.S. (2021). This website conducts a search of a user selected cataloged seismic events database, within a specified radius and selected magnitudes, and then plots the events onto a map. At the time of our search, the database contained data from January 1, 1932 through September 15, 2021.

In our first search, the general seismicity of the region was analyzed by selecting an epicenter map listing all events of magnitude 4.0 and greater, recorded since 1932, within a 100 kilometer (62 mile) radius of the site, in accordance with guidelines of the California Division of Mines and Geology. This map illustrates the regional seismic history of moderate to large events. As depicted on Enclosure A-5, within Appendix A, the site lies within a relatively active region associated with the San Jacinto fault to the northeast.

In the second search, the micro seismicity of the area lying within a 10 kilometer (6.2 miles) radius of the site was examined by selecting an epicenter map listing events on the order of 1.0 and greater since 1978. The results of this search is a map that presents the seismic history around the area of the site with much greater detail, not permitted on the larger map. The reason for limiting the time period for the events on the detail map is to enhance the accuracy of the map. Events recorded prior to the mid to late 1970's are generally considered to be less accurate due to advancements in technology. As depicted on this map, Enclosure A-6, the San Jacinto fault zone to the northeast appears to be the source of numerous events.

In summary, the historical seismicity of the site entails numerous small to medium magnitude earthquake events occurring in the region around the subject site. Any future developments at the subject site should anticipate that moderate to large seismic events could occur very near the site.

Secondary Seismic Hazards

Other secondary seismic hazards generally associated with severe ground shaking during an earthquake include liquefaction, seismic-induced settlement, seiches and tsunamis, earthquake induced flooding, landsliding, and rockfalls.

Liquefaction: The site lies within an area mapped by the County of Riverside as having a very low potential for liquefaction (CRTLMA, 2021). The potential for liquefaction generally occurs during strong ground shaking within granular loose sediments where the groundwater is usually less than 50 feet below the ground surface. Although groundwater lies less than 50 feet beneath the site, as found during this investigation, the site is underlain by relatively dense to very dense older alluvial materials. Therefore, the possibility of liquefaction at the site is considered very low.

Seiches/Tsunamis: The potential for the site to be affected by a seiche or tsunami (earthquake generated wave) is considered nil due to absence of any large bodies of water near the site.

Flooding (Water Storage Facility Failure): There are no large water storage facilities located on or near the site which could possibly rupture during an earthquake and affect the site by flooding.

Seismically-Induced Landsliding: Due to the low relief of the site and surrounding region, the potential for landslides to occur at the site is considered nil.

Rockfalls: No large, exposed, loose or unrooted boulders are present above the site that could affect the integrity of the site.

Seismically-Induced Settlement: Settlement generally occurs within areas of loose, granular soils with relatively low density. Since the site is underlain by relatively dense to very dense older alluvial materials, the potential for settlement is considered very low. In addition, the recommended earthwork operations to be conducted during the development of the site should mitigate any near surface loose soil conditions.

SOILS AND SEISMIC DESIGN CRITERIA (California Building Code 2019)

Design requirements for structures can be found within Chapter 16 of the 2019 California Building Code (CBC) based on building type, use, and/or occupancy. The classification of use and occupancy of all proposed structures at the site, shall be the responsibility of the building official.

Site Classification

Chapter 20 of the ASCE 7-16 defines six possible site classes for earth materials that underlie any given site. Bedrock is assigned one of three of these six site classes and these are: A, B, or C. Soil is assigned as C, D, E, or F. Per ASCE 7-16, Site Class A and Site Class B shall be measured on-site or estimated by a geotechnical engineer, engineering geologist or seismologist for competent rock with moderate fracturing and weathering. Site Class A and Site Class B shall not be used if more than 10 feet of soil is between the rock surface and bottom of the spread footing or mat foundation. Site Class C can be used for very dense soil and soft rock with N values greater than 50 blows per foot. Site Class D can be used for stiff soil with N values ranging from 15 to 50 blows per foot. Site Class E is for soft clay soils with N values less than 15 blows per foot. Our investigation, mapping by others, and our experience in the site region indicates that the materials beneath the site are considered Site Class D stiff soils.

CBC Earthquake Design Summary

Earthquake design criteria have been formulated in accordance with the 2019 CBC and ASCE 7-16 for the site based on the results of our investigation to determine the Site Class and an assumed Risk Category II. However, these values should be reviewed and the final design should be performed by a qualified structural engineer familiar with the region. In addition, the building official should confirm the Risk Category utilized in our design (Risk Category II). Our design values are provided within Appendix D.

INFILTRATION TESTING AND TEST RESULTS

Infiltration Testing

Four borehole infiltration tests were conducted in general accordance with the Shallow Percolation Test procedure as outlined in the Design Handbook for Low Impact Development Best Management Practices (CRFCWCD, 2011). The general locations of

our tests are illustrated on Enclosures A-2 and A-3 and were conducted at the requested locations. Test borings were drilled to depths of approximately 7 feet below the existing ground surface on September 7, 2021 due to the presence of groundwater in order to maintain the required separation of 10 feet below the proposed infiltration system and groundwater. Subsequent to drilling, a 3-inch diameter, perforated PVC pipe wrapped in filter fabric was placed within each test hole and 3/4-inch gravel was placed between the outside of the pipe and the hole wall. Test holes were pre-soaked the same day as drilling. Testing took place the next day, September 8, 2021, within 26 hours but not before 15 hours, of the pre-soak. The holes were filled using water from a 200 gallon water tank. Test periods consisted of allowing the water to drop in 30-minute intervals. After each reading, the hole was refilled. Testing was terminated after a total of 12 readings were recorded.

Infiltration test results are summarized in the following table:

Test No.	Depth*	Infiltration Rate** (in/hr)
P-1	7	0.03
P-2	7	0.05

* depth measured below existing ground surface
** Porchet Method determined rate

The results of this testing are presented as Enclosures E-1 and E-2 in Appendix E. The test results indicate non-conductive infiltration characteristics for the soils tested.

CONCLUSIONS

This investigation provides a broad overview of the geotechnical and geologic factors which are expected to influence future site planning and development. On the basis of our field investigation and testing program, it is the opinion of LOR Geotechnical Group, Inc., that the proposed development of the site for the proposed use is feasible from a geotechnical standpoint, provided the recommendations presented in this report are incorporated into design and implemented during grading and construction.

It should be noted that the subsurface conditions encountered in our exploratory borings are indicative of the locations explored and the subsurface conditions may vary. If conditions are encountered during the construction of the project that differ significantly from those presented in this report, this firm should be notified immediately so we may assess the impact to the recommendations provided.

Foundation Support

To provide adequate support for the proposed structure, we recommend that a compacted fill mat be constructed beneath footings and slabs. The compacted fill mat will provide a dense, high-strength soil layer to uniformly distribute the anticipated foundation loads over the underlying soils. The construction of this compacted fill mat will allow for the removal of the existing fill material which was loose and any current subsurface improvements, such as utilities, foundations, etc., that may be present locally.

Conventional foundation systems utilizing either individual spread footings and/or continuous wall footings will provide adequate support for the anticipated downward and lateral loads when utilized in conjunction with the recommended fill mat.

Soil Expansiveness

Our expansion index testing of a representative sample of the on-site soils indicates a very low expansion potential. For very low expansive soils, no specialized construction procedures to resist expansive soil activity are necessary.

Careful evaluation of onsite soils and any import fill for their expansion potential should be conducted during the grading operation.

Sulfate Protection

The results of the soluble sulfate tests conducted on selected subgrade soils expected to be encountered at foundation levels indicate that there is a negligible sulfate exposure to concrete elements in contact with the on site soils per the 2019 CBC. Therefore, no specific recommendations are given for concrete elements to be in contact with the onsite soils.

Infiltration

The results of our field investigation and test data indicates the site soils at the depths tested are not conducive to infiltration. Based on the results of this investigation, infiltration may not occur at deeper depths to the presence of groundwater. Shallow depth infiltration rates are anticipated to be similar to those found at the depths tested.

Geologic Mitigations

No special mitigation methods are deemed necessary at this time, other than the geotechnical recommendations provided in the following sections.

Seismicity

Seismic ground rupture is generally considered most likely to occur along pre-existing active faults. Since no known faults are known to exist at, or project into the site, the probability of ground surface rupture occurring at the site is considered nil.

Due to the site's close proximity to the faults described above, it is reasonable to expect a relatively strong ground motion seismic event to occur during the lifetime of the proposed development on the site. Large earthquakes could occur on other faults in the general area, but because of their lesser anticipated magnitude and/or greater distance, they are considered less significant than the faults described above from a ground motion standpoint.

The effects of ground shaking anticipated at the subject site should be mitigated by the seismic design requirements and procedures outlined in Chapter 16 of the California Building Code. However, it should be noted that the current building code requires the minimum design to allow a structure to remain standing after a seismic event, in order to allow for safe evacuation. A structure built to code may still sustain damage which might ultimately result in the demolishing of the structure (Larson and Slosson, 1992).

No secondary seismic hazards are anticipated to impact the proposed development.

RECOMMENDATIONS

Geologic Recommendations

No special geologic recommendations are deemed necessary at this time, other than the geotechnical recommendations provided in the following sections.

General Site Grading

It is imperative that no clearing and/or grading operations be performed without the presence of a qualified geotechnical engineer. An onsite, pre-job meeting with the developer, the contractor, the jurisdictional agency, and the geotechnical engineer should

occur prior to all grading related operations. Operations undertaken at the site without the geotechnical engineer present may result in exclusions of affected areas from the final compaction report for the project.

Grading of the subject site should be performed in accordance with the following recommendations as well as applicable portions of the California Building Code, and/or applicable local ordinances.

All areas to be graded should be stripped of significant vegetation and other deleterious materials.

Any undocumented fill encountered during grading should be completely removed, cleaned of significant deleterious materials, and may be reused as compacted fill. It is our recommendation that any existing fills under any proposed flatwork and paved areas be removed and replaced with engineered compacted fill. If this is not done, premature structural distress (settlement) of the flatwork and pavement may occur.

Cavities created by removal of subsurface obstructions, which are anticipated in areas of the site which were previously developed, should be thoroughly cleaned of loose soil, organic matter and other deleterious materials, shaped to provide access for construction equipment, and backfilled as recommended in the following Engineered Compacted Fill section of this report.

Initial Site Preparation

The existing fill material and any loose older alluvial soils, if encountered, should be removed from all proposed structural and/or fill areas. The data developed during this investigation indicates that removals on the order of 2 to 5 feet deep, exclusive of the end dump stockpiles, will be required from proposed development areas in order to encounter competent older alluvium upon which engineered compacted fill can be placed. The given removal depths are preliminary. Deeper fills are anticipated to be present, locally, primarily in areas of previous improvements. Removals should expose alluvial materials with an in-situ relative compaction of at least 85 percent (ASTM D 1557) or engineered compacted fill with an in-situ relative compaction of at least 90 percent (ASTM D 1557). The actual depths of the removals should be determined during the grading operation by observation and/or in-place density testing.

Preparation of Fill Areas

Prior to placing fill, the surfaces of all areas to receive fill should be scarified to a minimum depth of 12 inches. The scarified soil should be brought to near optimum moisture content and compacted to a relative compaction of at least 90 percent (ASTM D 1557).

Engineered Compacted Fill

The onsite soils should provide adequate quality fill material, provided they are free from oversized and/or organic matter and other deleterious materials. Unless approved by the geotechnical engineer, rock or similar irreducible material with a maximum dimension greater than 6 inches should not be buried or placed in fills.

If required, import fill should be inorganic, non-expansive granular soils free from rocks or lumps greater than 6 inches in maximum dimension. Sources for import fill should be approved by the geotechnical engineer prior to their use. Fill should be spread in maximum 8-inch uniform, loose lifts, each lift brought to near optimum moisture content, and compacted to a relative compaction of at least 90 percent in accordance with ASTM D 1557.

Preparation of Foundation Areas

All footings should rest upon at least 24 inches of properly compacted fill material placed over competent alluvium. In areas where the required fill thickness is not accomplished by the recommended removals or by site rough grading, the footing areas should be further subexcavated to a depth of at least 24 inches below the proposed footing base grade, with the subexcavation extending at least 5 feet beyond the footing lines. The bottom of all excavations should be scarified to a depth of 12 inches, brought to near optimum moisture content, and recompacted to at least 90 percent relative compaction (ASTM D 1557) prior to the placement of compacted fill.

Concrete floor slabs should bear on a minimum of 24 inches of compacted soil. This should be accomplished by the recommendations provided above. The final pad surfaces should be rolled to provide smooth, dense surfaces upon which to place the concrete.

Short-Term Excavations

Following the California Occupational and Safety Health Act (CAL-OSHA) requirements, excavations 5 feet deep and greater should be sloped or shored. All excavations and

shoring should conform to CAL-OSHA requirements. Short-term excavations of 5 feet deep and greater shall conform to Title 8 of the California Code of Regulations, Construction Safety Orders, Section 1504 and 1539 through 1547. Based on our exploratory borings, it appears that Type C soils are the predominant type of soil on the project and all short-term excavations should be based on this type of soil.

Deviation from the standard short-term slopes are permitted using option 4, Design by a Registered Professional Engineer (Section 1541.1).

Short-term excavation construction and maintenance are the responsibility of the contractor and should be a consideration of his methods of operation and the actual soil conditions encountered.

Slope Construction

Preliminary data indicates that cut and fill slopes should be constructed no steeper than two horizontal to one vertical. Fill slopes should be overfilled during construction and then cut back to expose fully compacted soil. A suitable alternative would be to compact the slopes during construction, then roll the final slopes to provide dense, erosion-resistant surfaces.

Slope Protection

Since the site soil materials are susceptible to erosion by running water, measures should be provided to prevent surface water from flowing over slope faces. Slopes at the project should be planted with a deep rooted ground cover as soon as possible after completion. The use of succulent ground covers such as iceplant or sedum is not recommended. If watering is necessary to sustain plant growth on slopes, then the watering operation should be monitored to assure proper operation of the irrigation system and to prevent over watering.

Soil Expansiveness

The upper materials encountered during this investigation were tested and found to have a very low expansion potential. Therefore, specialized construction procedures to specifically resist expansive soil activity are not anticipated at this time.

Additional evaluation of on-site and any imported soils for their expansion potential should be conducted following completion of the grading operation.

Foundation Design

If the site is prepared as recommended, the proposed structure may be safely founded on conventional shallow foundations, either individual spread footings and/or continuous wall footings, bearing on a minimum of 24 inches of engineered compacted fill placed over competent older alluvial materials. Foundations should have a minimum width of 12 inches and should be established a minimum of 12 inches below lowest adjacent grade.

For the minimum width and depth, footings may be designed using a maximum soil bearing pressure of 1,800 pounds per square foot (psf) for dead plus live loads. Footings at least 15 inches wide, placed at least 18 inches below the lowest adjacent final grade, may be designed for a maximum soil bearing pressure of 2,100 psf for dead plus live loads.

The above values are net pressures; therefore, the weight of the foundations and the backfill over the foundations may be neglected when computing dead loads. The values apply to the maximum edge pressure for foundations subjected to eccentric loads or overturning. The recommended pressures apply for the total of dead plus frequently applied live loads, and incorporate a factor of safety of at least 3.0. The allowable bearing pressures may be increased by one-third for temporary wind or seismic loading. The resultant of the combined vertical and lateral seismic loads should act within the middle one-third of the footing width. The maximum calculated edge pressure under the toe of foundations subjected to eccentric loads or overturning should not exceed the increased allowable pressure. The buildings should be setback from slopes as indicted within the California Building Code (2019).

Resistance to lateral loads will be provided by passive earth pressure and base friction. For footings bearing against compacted fill, passive earth pressure may be considered to be developed at a rate of 300 pounds per square foot per foot of depth. Base friction may be computed at 0.30 times the normal load. Base friction and passive earth pressure may be combined without reduction. These values are for dead load plus live load and may be increased by one-third for wind or seismic loading.

Settlement

Total settlement of individual foundations will vary depending on the width of the foundation and the actual load supported. Maximum settlement of shallow foundations designed and constructed in accordance with the preceding recommendations are estimated to be on the order of 0.5 inch. Differential settlements between adjacent footings should be about one-half of the total settlement. Settlement of all foundations is expected to occur rapidly,

primarily as a result of elastic compression of supporting soils as the loads are applied, and should be essentially completed shortly after initial application of the loads.

Building Area Slab-on-Grade

To provide adequate support, concrete floor slabs-on-grade should bear on a minimum of 24 inches of engineered fill compacted soil. The final pad surfaces should be rolled to provide smooth, dense surfaces.

Slabs to receive moisture-sensitive coverings should be provided with a moisture vapor retarder/barrier. We recommend that a vapor retarder/barrier be designed and constructed according to the American Concrete Institute 302.1R, Concrete Floor and Slab Construction, which addresses moisture vapor retarder/barrier construction. At a minimum, the vapor retarder/barrier should comply with ASTM E1745 and have a nominal thickness of at least 10 mils. The vapor retarder/barrier should be properly sealed, per the manufacturer's recommendations, and protected from punctures and other damage. Per the Portland Cement Association, for slabs with vapor-sensitive coverings, a layer of dry, granular material (sand) should be placed under the vapor retarder/barrier.

For slabs in humidity-controlled areas, a layer of dry, granular material (sand) should be placed above the vapor retarder/barrier.

The slabs should be protected from rapid and excessive moisture loss which could result in slab curling. Careful attention should be given to slab curing procedures, as the site area is subject to large temperature extremes, humidity, and strong winds.

Exterior Flatwork

To provide adequate support, exterior flatwork improvements should rest on a minimum of 12 inches of soil compacted to at least 90 percent (ASTM D 1557).

Flatwork surface should be sloped a minimum of 1 percent away from buildings and slopes, to approved drainage structures.

Wall Pressures

The design of footings for retaining walls should be performed in accordance with the recommendations described earlier under Preparation of Foundation Areas and Foundation Design. For design of retaining wall footings, the resultant of the applied loads

should act in the middle one-third of the footing, and the maximum edge pressure should not exceed the basic allowable value without increase.

For design of retaining walls unrestrained against movement at the top, we recommend an active pressure of 49 pounds per square foot (psf) per foot of depth be used.

This assumes level backfill consisting of compacted, non-expansive, on-site soils placed against the structures and within the back cut slope extending upward from the base of the stem at 35 degrees from the vertical or flatter.

Retaining structures subject to uniform surcharge loads within a horizontal distance behind the structures equal to the structural height should be designed to resist additional lateral loads equal to 0.47 times the surcharge load. Any isolated or line loads from adjacent foundations or vehicular loading will impose additional wall loads and should be considered individually.

To avoid over stressing or excessive tilting during placement of backfill behind walls, heavy compaction equipment should not be allowed within the zone delineated by a 45 degree line extending from the base of the wall to the fill surface. The backfill directly behind the walls should be compacted using light equipment such as hand operated vibrating plates and rollers. No material larger than three inches in diameter should be placed in direct contact with the wall.

Wall pressures should be verified prior to construction, when the actual backfill materials and conditions have been determined. Recommended pressures are applicable only to level, non-expansive, properly drained backfill with no additional surcharge loadings. If inclined backfills are proposed, this firm should be contacted to develop appropriate active earth pressure parameters.

Preliminary Pavement Design

Testing and design for preliminary onsite pavement was conducted in accordance with the California Highway Design Manual.

Based upon our preliminary sampling and testing, and upon an assumed Traffic Index generally used for similar projects, it appears that the structural sections tabulated below should provide satisfactory pavements for the subject on-site pavement improvements:

AREA	T.I.	DESIGN R-VALUE	PRELIMINARY SECTION
On site vehicular parking with occasional truck traffic (ADTT=10)	6.0	40	0.25' AC / 0.50' AB or 5" JPCP / 4" AB
Light to moderate truck traffic (ADTT=25)	7.0	40	0.30'AC / 0.65'AB or 6" JPCP / 4" AB
AC - Asphalt Concrete AB - Class 2 Aggregate Base JPCP - Jointed Plain Concrete Pavement with MR \geq 550 psi			

The above structural sections are predicated upon 90 percent relative compaction (ASTM D 1557) of all utility trench backfills and 95 percent relative compaction (ASTM D 1557) of the upper 12 inches of pavement subgrade soils and of any aggregate base utilized. In addition, the aggregate base should meet Caltrans specifications for Class 2 Aggregate Base.

In areas of the pavement which will receive high abrasion loads due to start-ups and stops, or where trucks will move on a tight turning radius, consideration should be given to installing concrete pads. Such pads should be a minimum of 5 inch thick concrete, with a 6 inch thick aggregate base. Concrete pads are also recommended in areas adjacent to trash storage areas where heavier loads will occur due to operation of trucks lifting trash dumpsters.

The recommended concrete pavement sections should have a minimum modulus of rupture (MR) of 550 pounds per square inch (psi). Transverse joints should be sawcut in the pavement at approximately 12 to 15-foot intervals within 4 to 6 hours of concrete placement, or preferably sooner. Sawcut depth should be equal to approximately one quarter of slab thickness. Construction joints should be constructed such that adjacent sections butt directly against each other and are keyed into each other. Parallel pavement sections should also be keyed into each other.

It should be noted that all of the above pavement design was based upon the results of preliminary sampling and testing, and should be verified by additional sampling and testing during construction when the actual subgrade soils are exposed.

Infiltration

The results of our field investigation and test data indicates the site soils at the depths tested are not conducive to infiltration. Therefore, shallow water quality storm water systems should not incorporate on-site infiltration when determining storm water treatment capacity.

Construction Monitoring

Post investigative services are an important and necessary continuation of this investigation. Project plans and specifications should be reviewed by the project geotechnical consultant prior to construction to confirm that the intent of the recommendations presented in this report have been incorporated into the design. Additional R-value, expansion, and soluble sulfate content testing may be needed after/during site rough grading.

During construction, sufficient and timely geotechnical observation and testing should be provided to correlate the findings of this investigation with the actual subsurface conditions exposed during construction. Items requiring observation and testing include, but are not necessarily limited to, the following:

1. Site preparation-stripping and removals.
2. Excavations, including approval of the bottom of excavations prior to the processing and preparation of the bottom areas for fill placement.
3. Scarifying and recompacting prior to fill placement.
4. Foundation excavations.
5. Subgrade preparation for pavements and slabs-on-grade.
6. Placement of engineered compacted fill and backfill, including approval of fill materials and the performance of sufficient density tests to evaluate the degree of compaction being achieved.

LIMITATIONS

This report contains geotechnical conclusions and recommendations developed solely for use by Compass Danbe Real Estate Partners, LLC and their design consultants for the purposes described earlier. It may not contain sufficient information for other uses or the purposes of other parties. The contents should not be extrapolated to other areas or used for other facilities without consulting LOR Geotechnical Group, Inc.

The recommendations are based on interpretations of the subsurface conditions concluded from information gained from subsurface explorations and a surficial site reconnaissance. The interpretations may differ from actual subsurface conditions, which can vary horizontally and vertically across the site. If conditions are encountered during the construction of the project, which differ significantly from those presented in this report, this firm should be notified immediately so we may assess the impact to the recommendations provided. Due to possible subsurface variations, all aspects of field construction addressed in this report should be observed and tested by the project geotechnical consultant.

If parties other than LOR Geotechnical Group, Inc., provide construction monitoring services, they must be notified that they will be required to assume responsibility for the geotechnical phase of the project being completed by concurring with the recommendations provided in this report or by providing alternative recommendations.

The report was prepared using generally accepted geotechnical engineering practices under the direction of a state licensed geotechnical engineer. No warranty, expressed or implied, is made as to conclusions and professional advice included in this report. Any persons using this report for bidding or construction purposes should perform such independent investigations as deemed necessary to satisfy themselves as to the surface and subsurface conditions to be encountered and the procedures to be used in the performance of work on this project.

TIME LIMITATIONS

The findings of this report are valid as of this date. Changes in the condition of a property can, however, occur with the passage of time, whether they be due to natural processes or the work of man on this or adjacent properties. In addition, changes in the Standards-of-Practice and/or Governmental Codes may occur. Due to such changes, the findings of this report may be invalidated wholly or in part by changes beyond our control. Therefore, this report should not be relied upon after a significant amount of time without a review by LOR Geotechnical Group, Inc., verifying the suitability of the conclusions and recommendations.

CLOSURE

It has been a pleasure to assist you with this project. We look forward to being of further assistance to you as construction begins. Should conditions be encountered during construction that appear to be different than indicated by this report, please contact this office immediately in order that we might evaluate their effect.

Should you have any questions regarding this report, please do not hesitate to contact our office at your convenience.

Respectfully submitted,
LOR Geotechnical Group, Inc.

Andrew A. Tardie
Staff Geologist

Robert M. Markoff, CEG
Engineering Geologist

John P. Leuer, GE 2030
President

AAT:RMM:JPL:ss

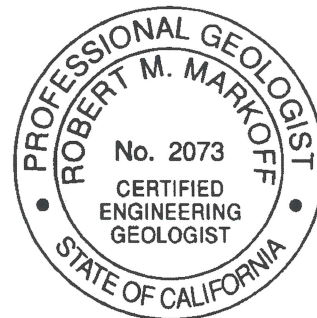

Distribution: Addressee (4) and PDF via email mbachli@danbe.com

REFERENCES

American Society of Civil Engineers, 2016, Minimum Design Load for Buildings and Other Structures, ASCE 7-16.

California Building Standards Commission and International Conference of Building Officials, 2019, California Building Code, 2019 Edition.

California Department of Water Resources, 2021, Online Water Data Library (WDL), <https://wdl.water.ca.gov/waterdatalibrary/Map.aspx>, accessed August 2021.

County of Riverside, Flood Control and Water Conservation District (CRFCWCD), 2011, Design Handbook for Low Impact Development Best Management Practices, dated September 2011.

County of Riverside, Transportation and Land Management Agency (CRTLMA), 2021, Geographic Information System, <http://www3.tlma.co.riverside.ca.us>, accessed August 2021.

Google Earth, 2021, Imagery from various years, www.google.com/earth.

Hart, E.W. and W.A. Bryant, 2010, Fault-Rupture Hazard Zones in California, California Dept. of Conservation Division of Mines and Geology Special Publication 42.

Historic Aerials (Nationwide Environmental Title Research, LLC), 2021, Imagery from Various Years, <https://www.historicaerials.com/>, accessed August 2021.

Larson, R., and Slosson, J., 1992, The Role of Seismic Hazard Evaluation in Engineering Reports, in Engineering Geology Practice in Southern California, AEG Special Publication Number 4, pp 191-194.

Morton, D.M. and B. Cox, 2001, Geologic Map of the Riverside East 7.5' Quadrangle, Riverside County, California, Open-File Report 01-452.

USGS, 2021, <https://earthquake.usgs.gov/earthquakes/map/>.

Watermaster Support Services, Western Municipal Water District, and San Bernardino Valley Water Conservation District, 2021, Cooperative Well Measuring Program, Spring 2021, Covering the Upper Santa Ana River Watershed, San Jacinto Watershed, and Santa Margarita Watershed, July 1, 2021.

APPENDIX A

**Index Map, Site Plan, Infiltration Location Map,
Regional Geologic Map, and
Historical Seismicity Maps**

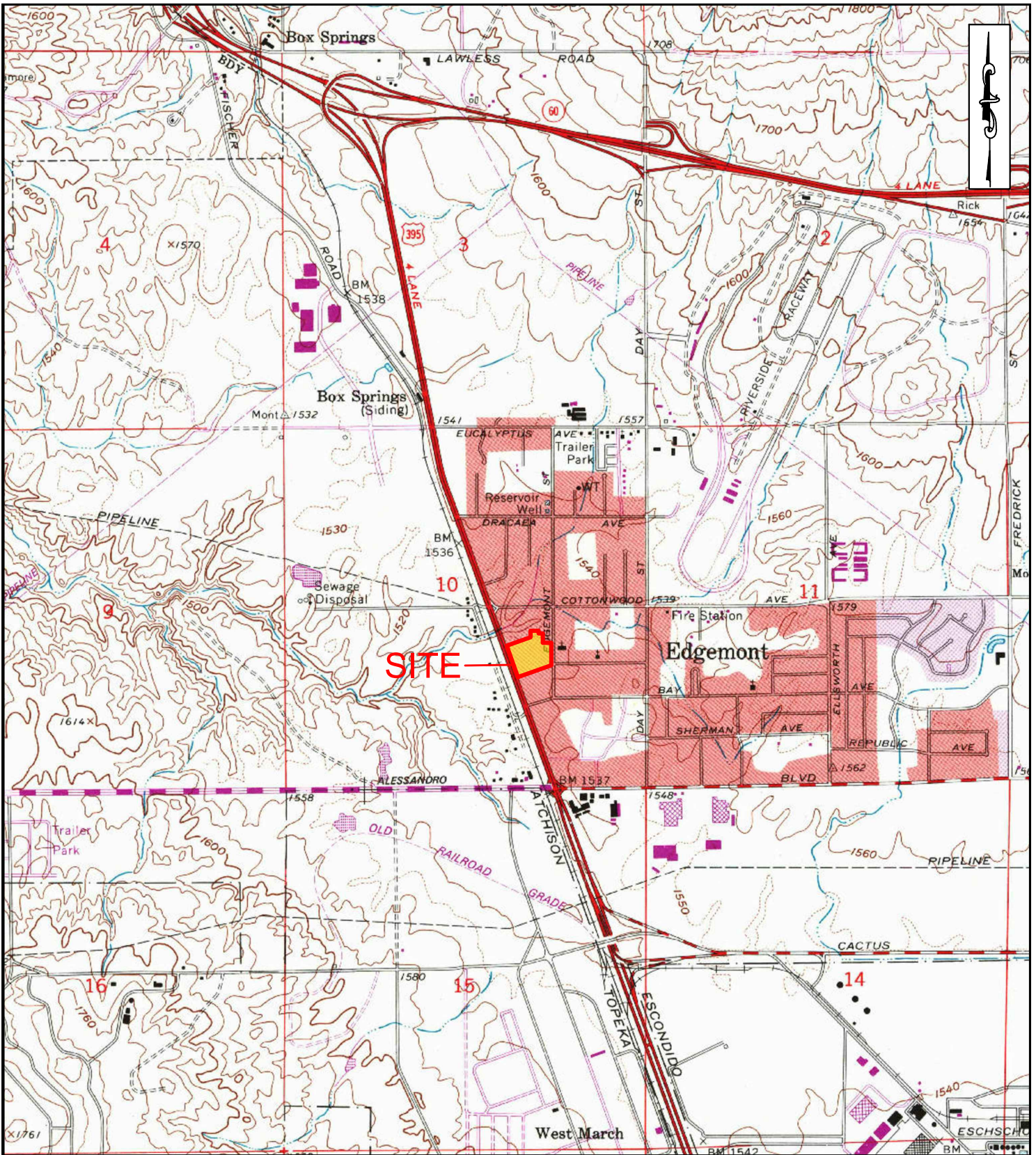

INDEX MAP

PROJECT: APNS 263-190-012, -014 THROUGH -019, AND -036, MORENO VALLEY, CALIFORNIA	PROJECT NO: 23756.1
CLIENT: COMPASS DANBE REAL ESTATE PARTNERS LLC	ENCLOSURE: A-1
LOR Geotechnical Group, Inc.	DATE: SEPTEMBER 2021
	SCALE: 1" ≈ 2,000'

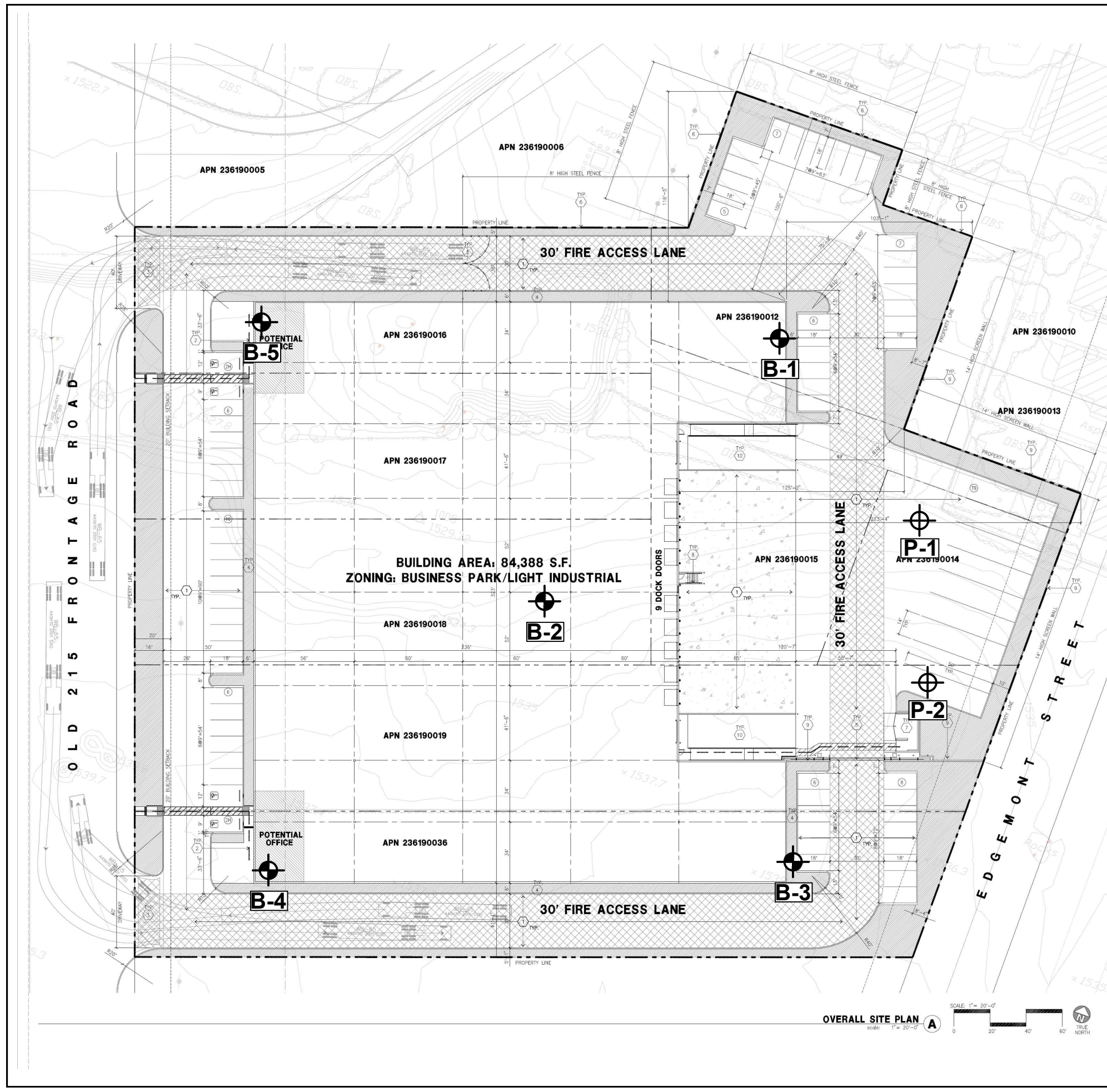

- SITE PLAN KEYNOTES**
- 1 HEAVY BRDM FINISH CONC. PAVEMENT,
 - 2 CONCRETE WALKWAY
 - 3 DECORATIVE DRIVEWAY APRONS MIN. 20' DEPTH
 - 4 CONCRETE EXTERIOR LANDING PAD TYP. AT ALL EXTERIOR MAN DOORS TO LANDSCAPE AREAS.
 - 5 PROVIDE 8" H METAL TUBULAR MANUALLY OPERATED GATES W/ KNOX-PAD LOCK PER FIRE DEPARTMENT STANDARDS.
 - 6 8" H TUBE STEEL FENCE
 - 7 TRASH ENCLOSURE
 - 8 EXTERIOR CONC. STAIR.
 - 9 CONCRETE TLT-UP SCREEN WALL.
 - 10 DRIVE THRU CONCRETE RAMP.

- SITE LEGEND**
- [Hatched Box] LANDSCAPED AREA
 - [Dotted Box] SITE PAVEMENT
 - [Cross-hatched Box] FIRE LANE
 - [Dashed Line] PROPERTY LINE
 - [Dotted Line] LOT LINE
 - [Empty Box] PARKING STALL (9' X 18')
 - [Hatched Box] HANDICAP PARKING STALL (9' X 18')
 - [Dashed Line] PATH OF TRAVEL

Legend
(Locations Approximate)

Map Symbols

- B-5** - Exploratory Boring
- P-2** - Percolation Test

hpa, inc.
18831 bardeen avenue, -ste. #100
Irvine, ca
92612
tel: 949-963-1770
fax: 949-963-0851
email: hpa@hparchs.com

Owner:

Project:

COTTONWOOD & EDMONT

MORENO VALLEY CA

Consultants:

CIVIL
STRUCTURAL
MECHANICAL
PLUMBING
ELECTRICAL
LANDSCAPE
FIRE PROTECTION
SOILS ENGINEER

Title: **OVERALL SITE PLAN**

Project Number: 21419
 Drawn by: CC
 Date: 08/12/21
 Revision:

SITE PLAN

PROJECT: APNS 263-190-012, -014 THROUGH -019, AND -036, MORENO VALLEY, CALIFORNIA	PROJECT NO.: 23756.1
CLIENT: COMPASS DANBE REAL ESTATE PARTNERS LLC	ENCLOSURE: A-2
LOR Geotechnical Group, Inc.	
DATE: SEPTEMBER 2021	SCALE: 1" ≈ 60'

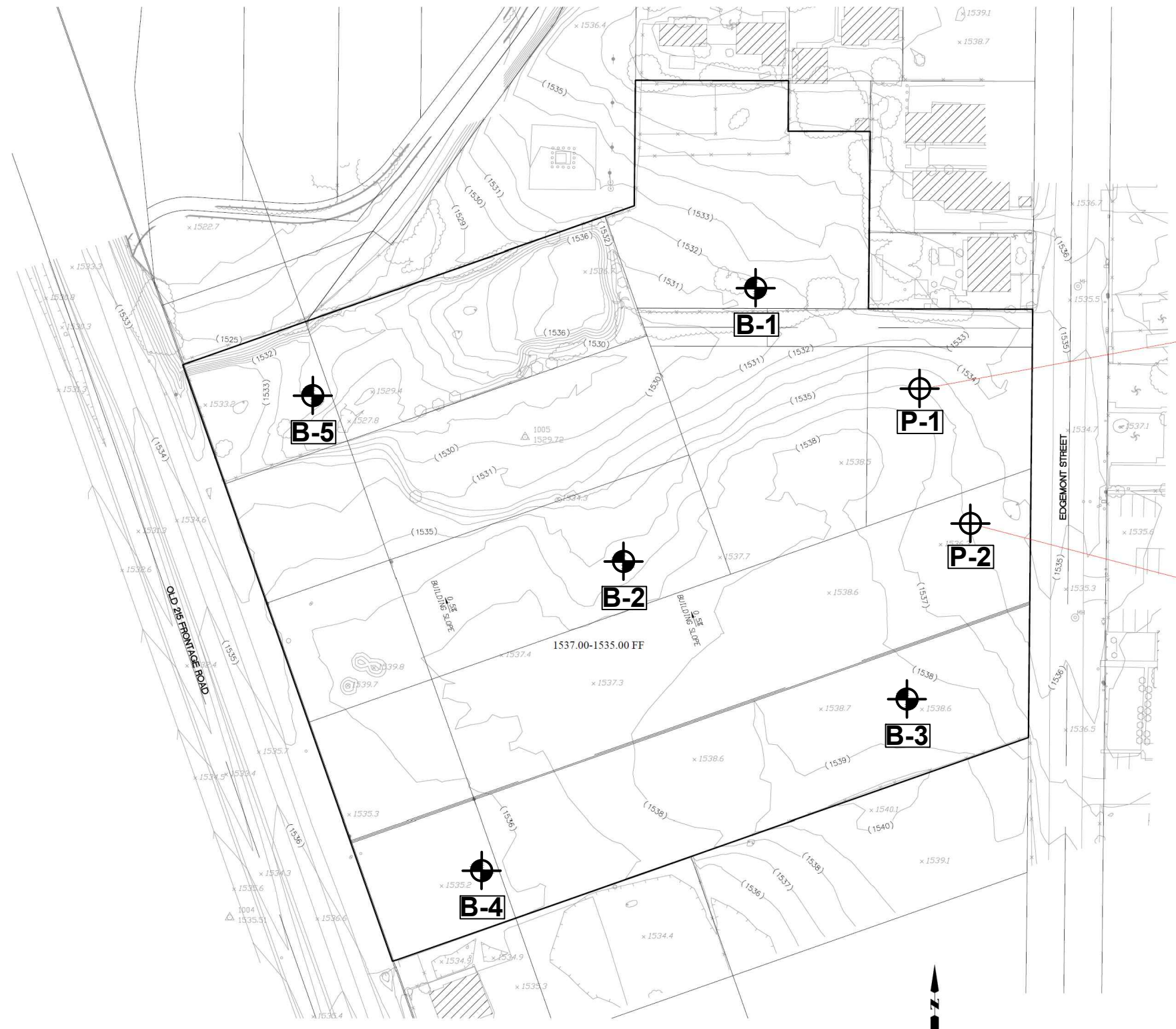

Legend

(Locations Approximate)

Map Symbols

- B-5** - Exploratory Boring
- P-2** - Percolation Test

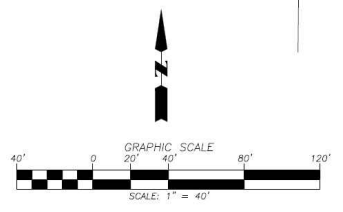

INFILTRATION LOCATION EXHIBIT
 APN 263-190-012, 014 to 019, 036
 OLD 215 / EDMONT STREET
 CITY OF MORENO VALLEY

8/18/2021

1470 EAST COOLEY DRIVE, COLTON, CA 92324
 PH. (909) 783-0101 FAX (909) 783-0108
 www.aei-casc.com

INFILTRATION LOCATION

PROJECT: APNS 263-190-012, -014 THROUGH -019, AND -036, MORENO VALLEY, CALIFORNIA	PROJECT NO.: 23756.1	ENCLOSURE: A-3
CLIENT: COMPASS DANBE REAL ESTATE PARTNERS LLC	DATE: SEPTEMBER 2021	SCALE: 1" ≈ 100'

LOR Geotechnical Group, Inc.

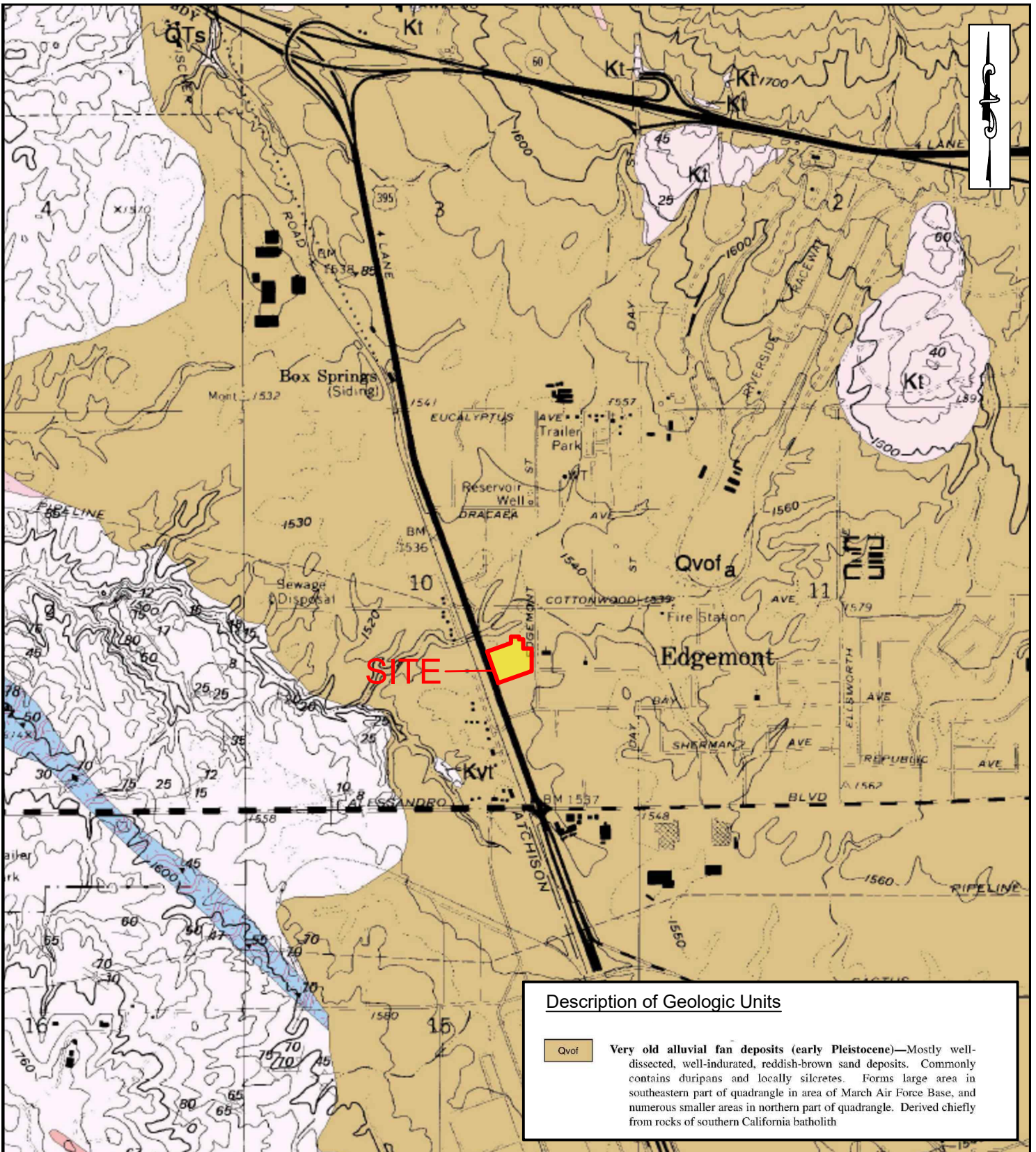

REGIONAL GEOLOGIC MAP

(Morton and Cox, 2001)

PROJECT: APNS 263-190-012, -014 THROUGH -019, AND -036, MORENO VALLEY, CALIFORNIA	PROJECT NO: 23756.1
CLIENT: COMPASS DANBE REAL ESTATE PARTNERS LLC	ENCLOSURE: A-4
LOR Geotechnical Group, Inc.	DATE: SEPTEMBER 2021
	SCALE: 1" ≈ 2,000'

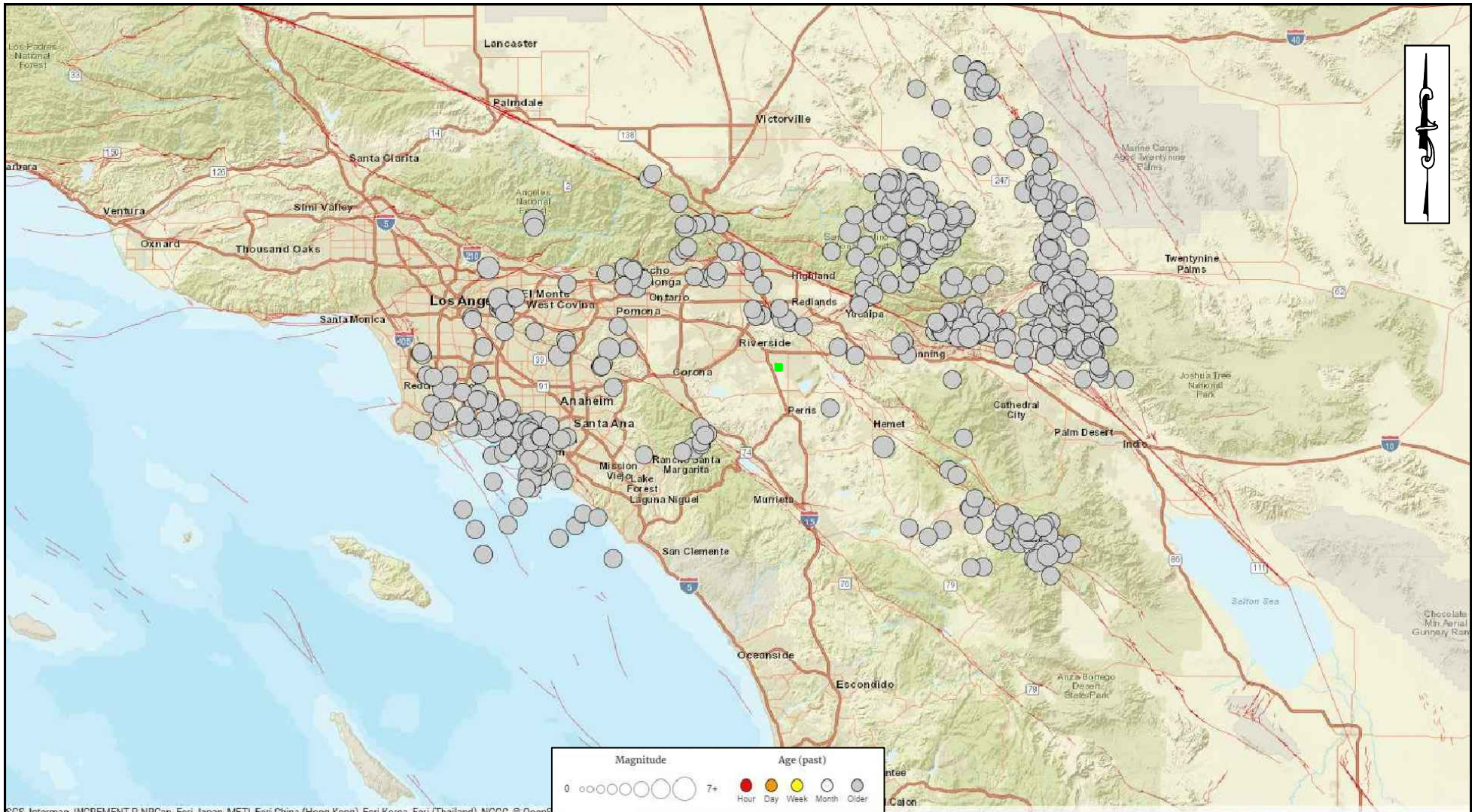

U.S. Geologic Survey (2021) real-time earthquake epicenter map. Plotted are 535 epicenters of instrument-recorded events from 1932 to present (09/15/21) of local magnitude of M4.0 and greater within a radius of ~62 miles (100 kilometers) of the site. Location accuracy varies. The site is indicated by the green square. The selected magnitude corresponds to a threshold intensity value where very light damage potential begins. These events are also generally widely felt by persons. Red lines mark the surface traces of known Quaternary-age faults.

HISTORICAL SEISMICITY MAP - 100km Radius

PROJECT:	APNS 263-190-012, -014 THROUGH -019, AND -036, MORENO VALLEY, CALIFORNIA	PROJECT NO:	23756.1
CLIENT:	COMPASS DANBE REAL ESTATE PARTNERS LLC	ENCLOSURE:	A-5
LOR Geotechnical Group, Inc.		DATE:	SEPTEMBER 2021
		SCALE:	1" ≈ 40km

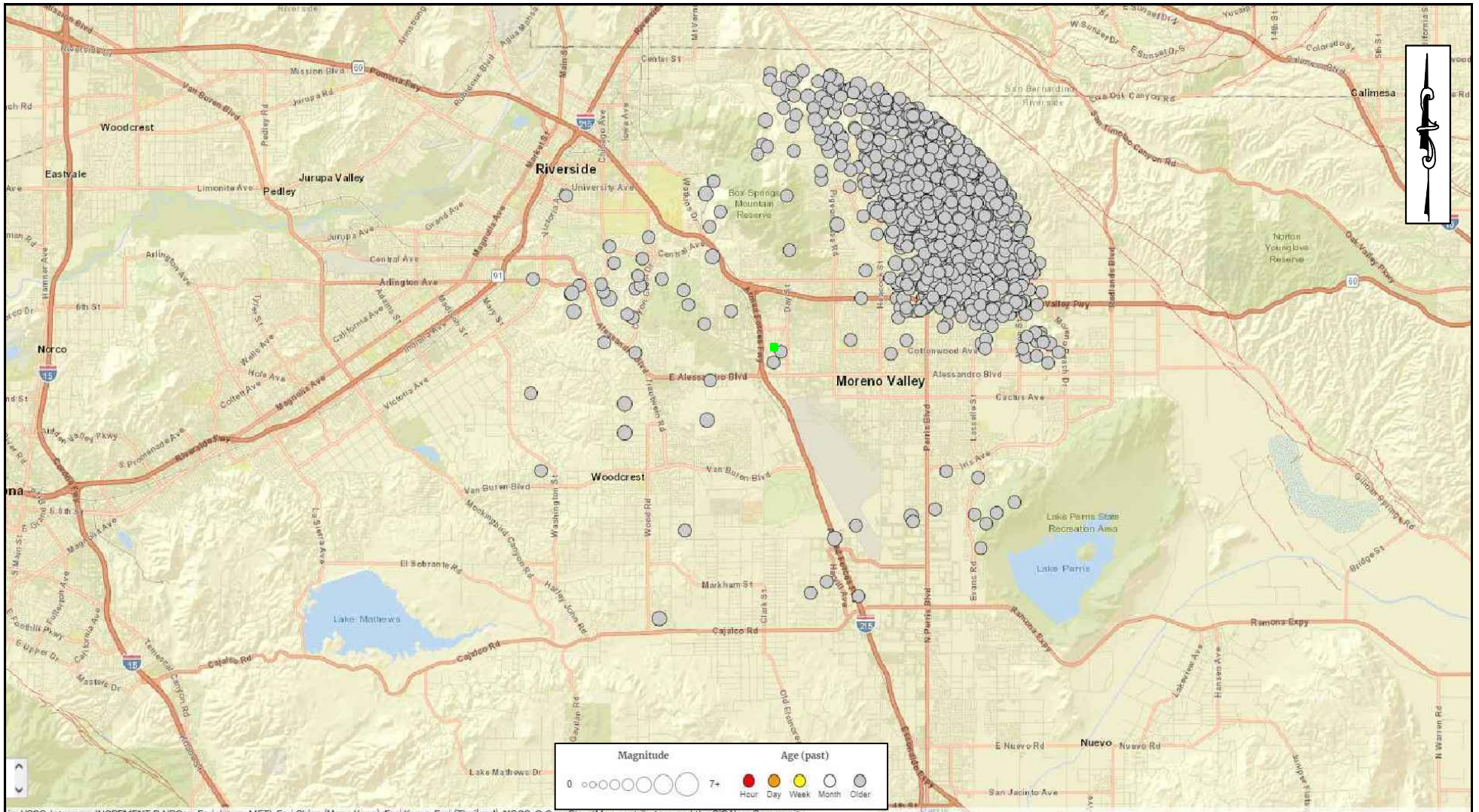

U.S. Geologic Survey (2021) real-time earthquake epicenter map. Plotted are 1096 epicenters of instrument-recorded events from 1978 to present (09/15/21) of local magnitude of M1.0 and greater within a radius of ~6.2 miles (10 kilometers) of the site. Location accuracy varies. The site is indicated by the green square. The selected magnitude corresponds to a threshold intensity value where very light damage potential begins. These events are also generally widely felt by persons. Red lines mark the surface traces of known Quaternary-age faults.

HISTORICAL SEISMICITY MAP - 10km Radius

PROJECT:	APNS 263-190-012, -014 THROUGH -019, AND -036, MORENO VALLEY, CALIFORNIA	PROJECT NO:	23756.1
CLIENT:	COMPASS DANBE REAL ESTATE PARTNERS LLC	ENCLOSURE:	A-6
LOR Geotechnical Group, Inc.		DATE:	SEPTEMBER 2021
		SCALE:	1" ≈ 6km

APPENDIX B

Field Investigation Program and Boring Logs

APPENDIX B **FIELD INVESTIGATION**

Subsurface Exploration

Our subsurface exploration of the site consisted of drilling 5 exploratory borings to depths between approximately 21.5 and 51.5 feet below the existing ground surface using a Mobile B-61 drill rig on September 7, 2021. The approximate locations of the borings are shown on Enclosures A-2 and A-3 within Appendix A.

The drilling exploration was conducted using a Mobile B-61 drill rig equipped with 8-inch diameter hollow stem augers. The soils were continuously logged by a geologist from this firm who inspected the site, created detailed logs of the borings, obtained undisturbed, as well as disturbed, soil samples for evaluation and testing, and classified the soils by visual examination in accordance with the Unified Soil Classification System.

Relatively undisturbed samples of the subsoils were obtained at a maximum interval of 5 feet. The samples were recovered by using a California split barrel sampler of 2.50 inch inside diameter and 3.25 inch outside diameter or a Standard Penetration Sampler (SPT) from the ground surface to the total depth explored. The samplers were driven by a 140 pound automatic trip hammer dropped from a height of 30 inches. The number of hammer blows required to drive the sampler into the ground the final 12 inches were recorded and further converted to an equivalent SPT N-value. Factors such as efficiency of the automatic trip hammer used during this investigation (80%), borehole diameter (8"), and rod length at the test depth were considered for further computing of equivalent SPT N-values corrected for field procedures (N₆₀) which are included in the boring logs, Enclosures B-1 through B-5.

The undisturbed soil samples were retained in brass sample rings of 2.42 inches in diameter and 1.00 inch in height, and placed in sealed plastic containers. Disturbed soil samples were obtained at selected levels within the borings and placed in sealed containers for transport to our geotechnical laboratory.

All samples obtained were taken to our geotechnical laboratory for storage and testing. Detailed logs of the borings are presented on the enclosed Boring Logs, Enclosures B-1 through B-5. A Boring Log Legend is presented on Enclosure B-i. A Soil Classification Chart is presented as Enclosure B-ii.

CONSISTENCY OF SOIL

SAMPLE KEY

SANDS

SPT BLOWS

CONSISTENCY

0-4	Very Loose
4-10	Loose
10-30	Medium Dense
30-50	Dense
Over 50	Very Dense

COHESIVE SOILS

SPT BLOWS

CONSISTENCY

0-2	Very Soft
2-4	Soft
4-8	Medium
8-15	Stiff
15-30	Very Stiff
30-60	Hard
Over 60	Very Hard

Symbol

Description



INDICATES CALIFORNIA
SPLIT SPOON SOIL
SAMPLE

INDICATES BULK SAMPLE

INDICATES SAND CONE
OR NUCLEAR DENSITY
TEST

INDICATES STANDARD
PENETRATION TEST (SPT)
SOIL SAMPLE













TYPES OF LABORATORY TESTS

- 1 Atterberg Limits
- 2 Consolidation
- 3 Direct Shear (undisturbed or remolded)
- 4 Expansion Index
- 5 Hydrometer
- 6 Organic Content
- 7 Proctor (4", 6", or Cal216)
- 8 R-value
- 9 Sand Equivalent
- 10 Sieve Analysis
- 11 Soluble Sulfate Content
- 12 Swell
- 13 Wash 200 Sieve

BORING LOG LEGEND

PROJECT: PROPOSED INDUSTRIAL BUILDING, MORENO VALLEY, CALIFORNIA	PROJECT NO.: 23756.1
CLIENT: COMPASS DANBE REAL ESTATE PARTNERS, LLC	ENCLOSURE: B-i
LOR Geotechnical Group, Inc.	DATE: SEPTEMBER 2021

SOIL CLASSIFICATION CHART

MAJOR DIVISIONS			SYMBOLS		TYPICAL DESCRIPTIONS
			GRAPH	LETTER	
COARSE GRAINED SOILS MORE THAN 50% OF MATERIAL IS LARGER THAN NO. 200 SIEVE SIZE	GRAVEL AND GRAVELLY SOILS MORE THAN 50% OF COARSE FRACTION RETAINED ON NO. 4 SIEVE	CLEAN GRAVELS <small>(LITTLE OR NO FINES)</small>		GW	WELL-GRADED GRAVELS, GRAVEL - SAND MIXTURES, LITTLE OR NO FINES
		GRAVELS WITH FINES <small>(APPRECIABLE AMOUNT OF FINES)</small>		GP	POORLY-GRADED GRAVELS, GRAVEL - SAND MIXTURES, LITTLE OR NO FINES
		GRAVELS WITH FINES <small>(APPRECIABLE AMOUNT OF FINES)</small>		GM	SILTY GRAVELS, GRAVEL - SAND - SILT MIXTURES
	SAND AND SANDY SOILS MORE THAN 50% OF COARSE FRACTION PASSING ON NO. 4 SIEVE	CLEAN SANDS <small>(LITTLE OR NO FINES)</small>		SW	WELL-GRADED SANDS, GRAVELLY SANDS, LITTLE OR NO FINES
		SANDS WITH FINES <small>(APPRECIABLE AMOUNT OF FINES)</small>		SP	POORLY-GRADED SANDS, GRAVELLY SAND, LITTLE OR NO FINES
		SANDS WITH FINES <small>(APPRECIABLE AMOUNT OF FINES)</small>		SM	SILTY SANDS, SAND - SILT MIXTURES
FINE GRAINED SOILS MORE THAN 50% OF MATERIAL IS SMALLER THAN NO. 200 SIEVE SIZE	SILTS AND CLAYS LIQUID LIMIT LESS THAN 50	SILTS AND CLAYS		ML	INORGANIC SILTS AND VERY FINE SANDS, ROCK FLOUR, SILTY OR CLAYEY FINE SANDS OR CLAYEY SILTS WITH SLIGHT PLASTICITY
		SILTS AND CLAYS		CL	INORGANIC CLAYS OF LOW TO MEDIUM PLASTICITY, GRAVELLY CLAYS, SANDY CLAYS, SILTY CLAYS, LEAN CLAYS
		SILTS AND CLAYS		OL	ORGANIC SILTS AND ORGANIC SILTY CLAYS OF LOW PLASTICITY
	SILTS AND CLAYS LIQUID LIMIT GREATER THAN 50	SILTS AND CLAYS		MH	INORGANIC SILTS, MICACEOUS OR DIATOMACEOUS FINE SAND OR SILTY SOILS
		SILTS AND CLAYS		CH	INORGANIC CLAYS OF HIGH PLASTICITY
		SILTS AND CLAYS		OH	ORGANIC CLAYS OF MEDIUM TO HIGH PLASTICITY, ORGANIC SILTS
HIGHLY ORGANIC SOILS				PT	PEAT, HUMUS, SWAMP SOILS WITH HIGH ORGANIC CONTENTS

NOTE: DUAL SYMBOLS ARE USED TO INDICATE BORDERLINE SOIL CLASSIFICATIONS

PARTICLE SIZE LIMITS

BOULDERS	COBBLES	GRAVEL		SAND			SILT OR CLAY
		COARSE	FINE	COARSE	MEDIUM	FINE	
12"	3"	3/4"	No. 4	No. 10	No. 40	200	
(U.S. STANDARD SIEVE SIZE)							

SOIL CLASSIFICATION CHART

PROJECT PROPOSED INDUSTRIAL BUILDING, MORENO VALLEY, CALIFORNIA	PROJECT NO. 23756.1
CLIENT: COMPASS DANBE REAL ESTATE PARTNERS, LLC	ENCLOSURE: B-ii
LOR Geotechnical Group, Inc.	DATE: SEPTEMBER 2021

LOG OF BORING B-1

TEST DATA

DEPTH IN FEET	SPT BLOW COUNTS	LABORATORY TESTS	MOISTURE CONTENT (%)	DRY DENSITY (PCF)	SAMPLE TYPE	LITHOLOGY	U.S.C.S.	DESCRIPTION
0							SM	@ 0 feet, <u>FILL</u> : SILTY SAND, trace gravel to 3/4", approximately 10% coarse grained sand, 30% medium grained sand, 40% fine grained sand, 20% silty fines, brown, dry.
14	14		6.9	118.4	█			@ 2 feet, <u>ALLUVIUM</u> : SILTY SAND, approximately 10% coarse grained sand, 25% medium grained sand, 35% fine grained sand, 30% silty fines with trace of clay, brown, damp, trace pinhole porosity.
5	15		5.3	112.5	█			@ 5 feet, trace root hairs, trace pinhole porosity remains.
	43		11.6	120.7	█			@ 7 feet, <u>OLDER ALLUVIUM</u> : SILTY SAND, approximately 20% coarse grained sand, 25% medium grained sand, 30% fine grained sand, 25% silty fines with trace of clay, red brown, damp to moist, micaceous.
10	60		9.9	126.0	█			@ 10 feet, slightly coarser grained.
15	51		12.4	120.7	█			
					▽			@ 18 feet, groundwater.
20	85		10.5	122.1	█			
25	47		10.8	123.5	█			@ 25 feet, SILTY SAND, approximately 15% coarse grained sand, 20% medium grained sand, 40% fine grained sand, 25% silty fines with trace of clay, red, moist, micaceous.
								END OF BORING @ 26.5'
30								Fill to 2' Groundwater @ 18' No bedrock

PROJECT:	Proposed Industrial Building	PROJECT NUMBER:	23756.1
CLIENT:	Compass Danbe Real Estate Partners, LLC	ELEVATION:	1532
LOR GEOTECHNICAL GROUP INC.		DATE DRILLED:	September 7, 2021
		EQUIPMENT:	Mobile B-61
	HOLE DIA.:	8"	ENCLOSURE:

LOG OF BORING B-2

TEST DATA

DEPTH IN FEET	SPT BLOW COUNTS	LABORATORY TESTS	MOISTURE CONTENT (%)	DRY DENSITY (PCF)	SAMPLE TYPE	LITHOLOGY	U.S.C.S.
0	22	3, 4, 7 8, 9, 10 11	9.2	124.3	█	█	SM
5	19		9.0	125.7	█	█	SC
	75 for 11"		9.9	121.7	█	█	SM
10	83 for 10"		10.2	121.8	█	█	
15	62		10.6	122.6	█	█	
20	61		11.6			█	
25	52		12.2			█	
30	57		15.5			█	
35	71		14.2			█	
40	90		14.3			█	SW SM
45	84		15.1			█	
50	64		14.3			█	SM
55						█	

DESCRIPTION

@ 0 feet, **FILL: SILTY SAND**, approximately 5% gravel to 3/4", 15% coarse grained sand, 15% medium grained sand, 25% fine grained sand, 40% silty fines, light brown, dry, loose.

@ 2 feet, some asphalt concrete (AC) grindings, damp.

@ 3 feet, **OLDER ALLUVIUM: SILTY SAND**, approximately 10% coarse grained sand, 30% medium grained sand, 30% fine grained sand, 30% silty fines with trace of clay, red brown, damp.

@ 5 feet, **CLAYEY SAND**, approximately 5% coarse grained sand, 25% medium grained sand, 30% fine grained sand, 40% clayey fines of low plasticity, red brown, damp.

@ 7 feet, **SILTY SAND**, approximately 20% coarse grained sand, 25% medium grained sand, 35% fine grained sand, 20% silty fines with trace of clay, red brown, moist, slightly micaceous.

@ 10 feet, becomes slightly coarser grained, yellow brown.

@ 15 feet, **SILTY SAND**, approximately 15% coarse grained sand, 25% medium grained sand, 35% fine grained sand, 25% silty fines with trace of clay, red brown, moist, micaceous.

@ 20 feet, becomes slightly finer grained.

@ 34 feet, groundwater.

@ 35 feet, **SILTY SAND**, approximately 15% coarse grained sand, 30% medium grained sand, 35% fine grained sand, 20% silty fines, strong brown, moist, micaceous.

@ 40 feet, **WELL GRADED SAND WITH SILT**, approximately 25% coarse grained sand, 30% medium grained sand, 35% fine grained sand, 10% silty fines, brown, wet.

@ 50 feet, **SILTY SAND**, approximately 15% coarse grained sand, 25% medium grained sand, 35% fine grained sand, 25% silty fines, red brown, moist, micaceous.

END OF BORING @ 51.5'

Fill to 3'
Groundwater @ 34'
No bedrock

PROJECT: Proposed Industrial Building	PROJECT NUMBER: 23756.1
CLIENT: Compass Danbe Real Estate Partners, LLC	ELEVATION: 1535
LOR GEOTECHNICAL GROUP INC.	DATE DRILLED: September 7, 2021
	EQUIPMENT: Mobile B-61
	HOLE DIA.: 8" ENCLOSURE: B-2

LOG OF BORING B-3

TEST DATA

DEPTH IN FEET	SPT BLOW COUNTS	LABORATORY TESTS	MOISTURE CONTENT (%)	DRY DENSITY (PCF)	SAMPLE TYPE	LITHOLOGY	U.S.C.S.	DESCRIPTION
0		9, 10 11					SM	@ 0 feet, <u>FILL</u> : SILTY SAND, approximately 5% gravel to 3/4", 15% coarse grained sand, 25% medium grained sand, 30% fine grained sand, 25% silty fines with trace of clay, red brown, dry, loose. @ 1 foot, <u>OLDER ALLUVIUM</u> : SILTY SAND, approximately 5% gravel to 3/4", 25% coarse grained sand, 25% medium grained sand, 30% fine grained sand, 15% silty fines, yellow brown, moist.
56 for 11"		11.1		110.6				
5	56 for 11"		12.4	111.6				@ 5 feet, becomes red brown, slightly micaceous.
10	71		8.7	125.2				@ 10 feet, SILTY SAND, approximately 10% coarse grained sand, 30% medium grained sand, 30% fine grained sand, 30% silty fines with trace of clay, red brown, damp, micaceous.
15	59		11.0	125.3				@ 15 feet, increase in moisture.
20	63		11.2	121.2				@ 19 feet, groundwater.
END OF BORING @ 21.5'								
Fill to 1'								
Groundwater @ 19'								
No bedrock								

PROJECT: Proposed Industrial Building	PROJECT NUMBER: 23756.1
CLIENT: Compass Danbe Real Estate Partners, LLC	ELEVATION: 1538
LOR GEOTECHNICAL GROUP INC.	DATE DRILLED: September 7, 2021
	EQUIPMENT: Mobile B-61
	HOLE DIA.: 8" ENCLOSURE: B-3

LOG OF BORING B-4







TEST DATA

DEPTH IN FEET	TEST DATA					LITHOLOGY	U.S.C.S.	DESCRIPTION
	SPT BLOW COUNTS	LABORATORY TESTS	MOISTURE CONTENT (%)	DRY DENSITY (PCF)	SAMPLE TYPE			
0							SM	<p>@ 0 feet, <u>FILL</u>: SILTY SAND, approximately 15% coarse grained sand, 25% medium grained sand, 35% fine grained sand, 25% silty fines with trace of clay, red brown, dry, loose.</p> <p>@ 1 foot, some concrete debris present to 4' (no sample driven at 2').</p>
5	62		10.1	114.7	█			<p>@ 4 feet, <u>OLDER ALLUVIUM</u>: SILTY SAND, approximately 10% coarse grained sand, 30% medium grained sand, 40% fine grained sand, 20% silty fines, red brown, moist.</p>
10	72		8.2	125.0	█			<p>@ 10 feet, SILTY SAND, approximately 15% coarse grained sand, 30% medium grained sand, 40% fine grained sand, 15% silty fines, strong brown, damp, micaceous.</p>
15	74		12.2	123.3	█			<p>@ 15 feet, becomes moist.</p>
20	65		13.8	118.8	█			
END OF BORING @ 21.5'								<p>Fill to 4'</p> <p>No groundwater</p> <p>No bedrock</p>

PROJECT:	Proposed Industrial Building	PROJECT NUMBER:	23756.1
CLIENT:	Compass Danbe Real Estate Partners, LLC	ELEVATION:	1536
LOR GEOTECHNICAL GROUP INC.	DATE DRILLED:	September 7, 2021	
	EQUIPMENT:	Mobile B-61	
	HOLE DIA.: 8"	ENCLOSURE:	B-4

LOG OF BORING B-5

TEST DATA

DEPTH IN FEET	TEST DATA						DESCRIPTION	
	SPT BLOW COUNTS	LABORATORY TESTS	MOISTURE CONTENT (%)	DRY DENSITY (PCF)	SAMPLE TYPE	LITHOLOGY		U.S.C.S.
0		9, 10 11					SM	@ 0 feet, <u>FILL</u> : SILTY SAND with GRAVEL, approximately 15% gravel to 1", 10% coarse grained sand, 20% medium grained sand, 25% fine grained sand, 30% silty fines, brown, dry, loose. @ 1 foot, some debris (plastic).
27	27		4.2	119.1				
5	29		8.2	125.1				@ 5 feet, <u>OLDER ALLUVIUM</u> : SILTY SAND, approximately 5% coarse grained sand, 15% medium grained sand, 45% fine grained sand, 35% silty fines with trace of clay, brown, damp, trace pinhole porosity, some thin calcite stringers.
10	78		9.6	125.4				@ 10 feet, SILTY SAND, approximately 5% coarse grained sand, 25% medium grained sand, 40% fine grained sand, 30% silty fines with trace of clay, red brown, damp, micaceous.
15	62		10.9	124.8				
								@ 18 feet, groundwater.
20	60		10.9	122.0				
							END OF BORING @ 21.5'	
							Fill to 5'	
							Groundwater @ 18'	
							No bedrock	

PROJECT: Proposed Industrial Building	PROJECT NUMBER: 23756.1
CLIENT: Compass Danbe Real Estate Partners, LLC	ELEVATION: 1531
LOR GEOTECHNICAL GROUP INC.	DATE DRILLED: September 7, 2021
	EQUIPMENT: Mobile B-61
	HOLE DIA.: 8" ENCLOSURE: B-5

APPENDIX C

Laboratory Testing Program and Test Results

APPENDIX C LABORATORY TESTING

General

Selected soil samples obtained from the borings were tested in our geotechnical laboratory to evaluate the physical properties of the soils affecting foundation design and construction procedures. The laboratory testing program performed in conjunction with our investigation included moisture content, dry density, laboratory compaction characteristics, direct shear, sieve analysis, sand equivalent, R-value, expansion index, and soluble sulfate content. Descriptions of the laboratory tests are presented in the following paragraphs:

Moisture Density Tests

The moisture content and dry density information provides an indirect measure of soil consistency for each stratum, and can also provide a correlation between soils on this site. The dry unit weight and field moisture content were determined for selected undisturbed samples, in accordance with ASTM D 2921 and ASTM D 2216, respectively, and the results are shown on the boring logs, Enclosures B-1 through B-9 for convenient correlation with the soil profile.

Laboratory Compaction

A selected soil sample was tested in the laboratory to determine compaction characteristics using the ASTM D 1557 compaction test method. The results are presented in the following table:

LABORATORY COMPACTION				
Boring Number	Sample Depth (feet)	Soil Description (U.S.C.S.)	Maximum Dry Density (pcf)	Optimum Moisture Content (percent)
B-2	0-3	(SM) Silty Sand	136.5	6.5

Direct Shear Test

Shear tests are performed in general accordance with ASTM D 3080 with a direct shear machine at a constant rate-of-strain (0.04 inches/minute). The machine is designed to test a sample partially extruded from a sample ring in single shear. Samples are tested at varying normal loads in order to evaluate the shear strength parameters, angle of internal friction and cohesion. Samples are tested in remolded condition (90 percent relative compaction per ASTM D 1557) and soaked, to represent the worse case conditions expected in the field.

The results of the shear test on a selected soil sample is presented in the following table:

DIRECT SHEAR TEST				
Boring Number	Sample Depth (feet)	Soil Description (U.S.C.S.)	Apparent Cohesion (psf)	Angle of Internal Friction (degrees)
B-2	0-3	(SM) Silty Sand	500	22

Sieve Analysis

A quantitative determination of the grain size distribution was performed for selected samples in accordance with the ASTM D 422 laboratory test procedure. The determination is performed by passing the soil through a series of sieves, and recording the weights of retained particles on each screen. The results of the grain size distribution analyses are presented graphically on Enclosure C-1.

Sand Equivalent

The sand equivalent of selected soils were evaluated using the California Sand Equivalent Test Method, Caltrans Number 217. The results of the sand equivalent tests are presented with the grain size distribution analyses on Enclosure C-1.

R-Value Test

A soil sample was obtained at probable pavement subgrade level, and was tested to determine its R-value using the California R-Value Test Method, Caltrans Number 301. The results of the R-value test is presented on Enclosure C-1.

Expansion Index Test

Remolded samples are tested to determine their expansion potential in accordance with the Expansion Index (EI) test. The test is performed in accordance with the Uniform Building Code Standard 18-2. The test result for a select soil sample is presented in the following table:

EXPANSION INDEX TEST				
Boring Number	Sample Depth (feet)	Soil Description (U.S.C.S.)	Expansion Index (EI)	Expansion Potential
B-2	0-3	(SM) Silty Sand	9	Very Low
Expansion Index:				
	0-20 Very low	21-50 Low	51-90 Medium	91-130 High

Soluble Sulfate Content Test

The soluble sulfate content of a selected subgrade soil was evaluated. The concentration of soluble sulfates in the soil was determined by measuring the optical density of a barium sulfate precipitate. The precipitate results from a reaction of barium chloride with water extractions from the soil sample. The measured optical density is correlated with readings on precipitates of known sulfate concentrations. The test result is presented in the following table:

SOLUBLE SULFATE CONTENT TEST			
Boring Number	Sample Depth (feet)	Soil Description (U.S.C.S.)	Sulfate Content (% by weight)
B-2	0-3	(SM) Silty Sand	< 0.005
B-3	0-3	(SM) Silty Sand	< 0.005
B-5	0-3	(SM) Silty Sand	0.015

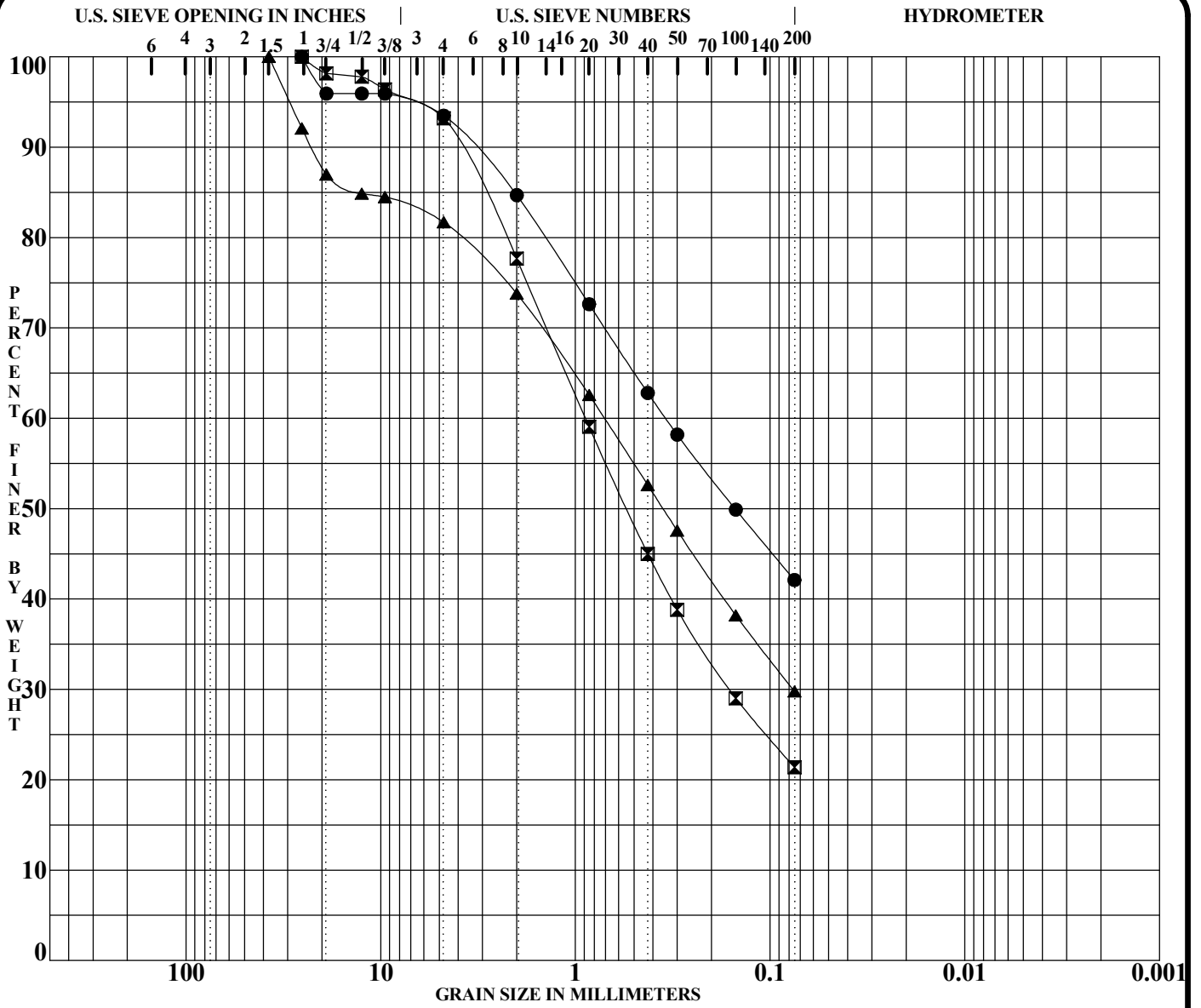

COBBLES	GRAVEL		SAND			SILT OR CLAY
	coarse	fine	coarse	medium	fine	

Specimen Identification	Soil Classification	SE	RV	PL	PI	Cc	Cu
● B-2 @ 0-3'	(SM) Silty Sand	15	39				
⊠ B-3 @ 0-3'	(SM) Silty Sand	28	--				
▲ B-5 @ 0-3'	(SM) Silty Sand with Gravel	18	--				

Specimen Identification	D100	D60	D30	D10	%Gravel	%Sand	%Silt	%Clay
● B-2 @ 0-3'	25.40	0.34			6.5	51.4	42.1	
⊠ B-3 @ 0-3'	25.40	0.89	0.161		6.8	71.8	21.4	
▲ B-5 @ 0-3'	37.50	0.71	0.076		18.3	51.9	29.8	

PROJECT: Proposed Industrial Building

PROJECT NO.: 23756.1

DATE: 9/17/21

GRADATION CURVES
 LOR Geotechnical Group, Inc.
 Riverside, CA 92507

ENCLOSURE C-1

APPENDIX D

Seismic Design Spectra

Project: Old 215 Industrial Development, Moreno Valley, California
Project Number: 23756.1
Client: Compass Danbe Real Estate Partners LP
Site Lat/Long: 33.92270 / -117.28452
Controlling Seismic Source: San Jacinto

REFERENCE	NOTATION	VALUE	REFERENCE	NOTATION	VALUE
Site Class	C, D, D default, or E	D measured	Fv (Table 11.4-2)[Used for General Spectrum]	F _v	1.7
Site Class D - Table 11.4-1	F _a	1.0	Design Maps	S _s	1.500
Site Class D - 21.3(ii)	F _v	2.5	Design Maps	S ₁	0.600
0.2*(S _{D1} /S _{DS})	T ₀	0.136	Equation 11.4-1 - F _A *S _s	S _{MS}	1.500*
S _{D1} /S _{DS}	T _s	0.680	Equation 11.4-3 - 2/3*S _{MS}	S _{DS}	1.00*
Fundamental Period (12.8.2)	T	Period	Design Maps	PGA	0.574
Seismic Design Maps or Fig 22-14	T _L	8	Table 11.8-1	F _{PGA}	1.1
Equation 11.4-4 - 2/3*S _{M1}	S _{D1}	0.680*	Equation 11.8-1 - F _{PGA} *PGA	PGA _M	0.631*
Equation 11.4-2 - F _v *S ₁	S _{M1}	1.020*	Section 21.5.3	80% of PGA _M	0.505
			Design Maps	C _{RS}	0.932
			Design Maps	C _{R1}	9.08
<u>RISK COEFFICIENT</u>					
Cr - At Periods <=0.2, Cr=C _{RS}	C _{RS}	0.932	Cr - At Periods between 0.2 and 1.0 use trendline formula to complete	Period	Cr
Cr - At Periods >=1.0, Cr=C _{R1}	C _{R1}	9.08		0.200	0.932
				0.300	1.951
				0.400	2.969
				0.500	3.988
				0.600	5.006
				0.680	5.821
				1.000	9.08

* Code based design value. See accompanying data for Site Specific Design values.

Mapped values from <https://seismicmaps.org/>

PROBABILISTIC SPECTRA¹
2% in 50 year Exceedence

Project No: 23756.1

Period	UGHM	RTHM	Max Directional Scale Factor ²	Probabilistic MCE
0.010	0.810	0.799	1.19	0.951
0.100	1.042	1.402	1.19	1.668
0.200	1.811	1.835	1.20	2.202
0.300	2.033	1.995	1.22	2.434
0.500	1.952	1.858	1.23	2.285
0.750	1.598	1.489	1.24	1.846
1.000	1.341	1.231	1.24	1.526
2.000	0.778	0.698	1.24	0.866
3.000	0.544	0.482	1.25	0.603
4.000	0.410	0.360	1.25	0.450
5.000	0.319	0.280	1.26	0.353

¹ Data Sources:

<https://earthquake.usgs.gov/hazards/interactive/>
<https://earthquake.usgs.gov/designmaps/rtgm/>

² Shahi-Baker RotD100/RotD50 Factors (2014)

Probabilistic PGA: 0.810
 Is Probabilistic $S_{a(max)} < 1.2F_a$? **NO**

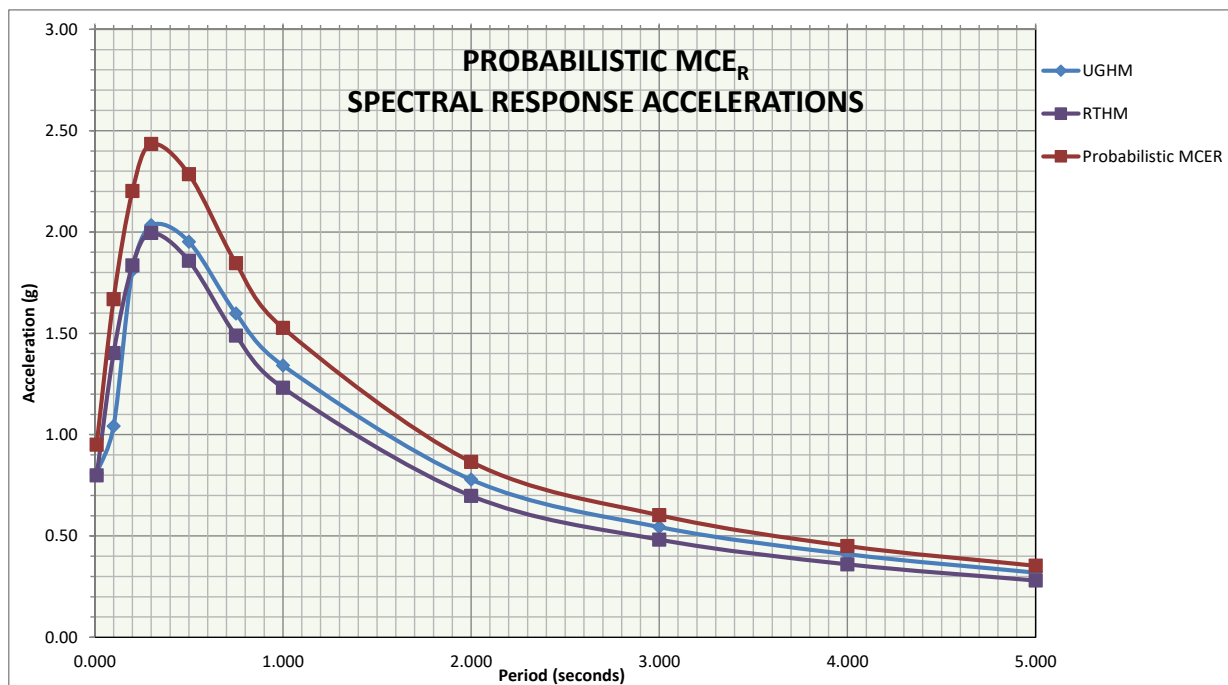

DETERMINISTIC SPECTRUM

Largest Amplitudes of Ground Motions Considering All Sources Calculated using Weighted Mean of Attenuation Equations¹

Controlling Source: San Jacinto

Is Probabilistic $S_{a(max)} < 1.2F_a$? **NO**

Period	Deterministic PSa Median + 1.σ for 5% Damping	Max Directional Scale Factor ²	Deterministic MCE	Section 21.2.2 Scaling Factor Applied
0.010	0.603	1.19	0.717	0.717
0.020	0.605	1.19	0.720	0.720
0.030	0.617	1.19	0.734	0.734
0.050	0.663	1.19	0.788	0.788
0.075	0.800	1.19	0.952	0.952
0.100	0.955	1.19	1.136	1.136
0.150	1.182	1.20	1.419	1.419
0.200	1.323	1.20	1.587	1.587
0.250	1.408	1.21	1.704	1.704
0.300	1.448	1.22	1.766	1.766
0.400	1.441	1.23	1.772	1.772
0.500	1.380	1.23	1.697	1.697
0.750	1.102	1.24	1.366	1.366
1.000	0.914	1.24	1.133	1.133
1.500	0.647	1.24	0.802	0.802
2.000	0.489	1.24	0.606	0.606
3.000	0.330	1.25	0.412	0.412
4.000	0.231	1.25	0.289	0.289
5.000	0.171	1.26	0.215	0.215

Project No: 23756.1

Is Deterministic $S_{a(max)} < 1.5*F_a$? **NO**
 Section 21.2.2 Scaling Factor: **N/A**
 Deterministic PGA: **0.603**
 Is Deterministic PGA $\geq F_{PGA} * 0.5$? **YES**

¹ NGAWest 2 GMPE worksheet and Uniform California Earthquake Rupture Forecast, Version 3 (UCERF3) - Time Dependent Model

² Shahi-Baker RotD100/RotD50 Factors (2014)

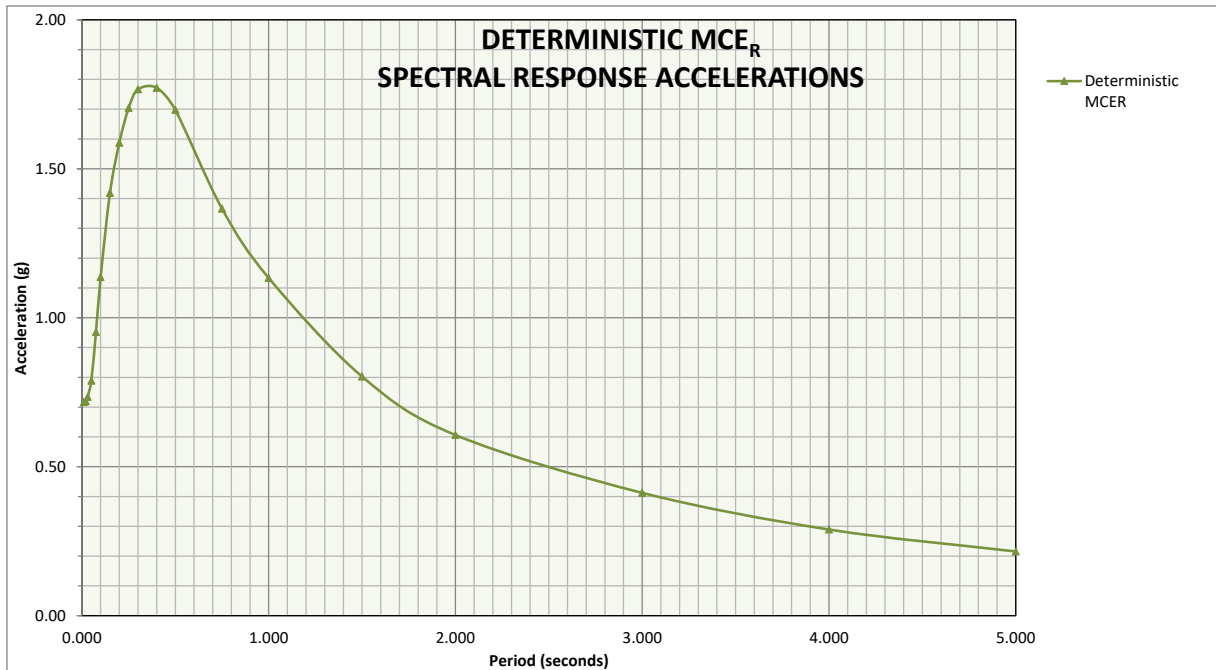

SITE SPECIFIC SPECTRA

Period	Probabilistic MCE	Deterministic MCE	Site-Specific MCE	Design Response Spectrum (Sa)
0.010	0.951	0.717	0.717	0.478
0.100	1.668	1.136	1.136	0.758
0.200	2.202	1.587	1.587	1.058
0.300	2.434	1.766	1.766	1.178
0.500	2.285	1.697	1.697	1.131
0.750	1.846	1.366	1.366	0.911
1.000	1.526	1.133	1.133	0.756
2.000	0.866	0.606	0.606	0.404
3.000	0.603	0.412	0.412	0.275
4.000	0.450	0.289	0.289	0.193
5.000	0.353	0.215	0.215	0.144

Period	ASCE 7 SECTION 11.4.6 General Spectrum	80% General Response Spectrum
0.005	0.422	0.338
0.010	0.444	0.355
0.020	0.488	0.391
0.030	0.532	0.426
0.050	0.621	0.496
0.060	0.665	0.532
0.075	0.731	0.585
0.090	0.797	0.638
0.100	0.841	0.673
0.110	0.885	0.708
0.120	0.929	0.744
0.136	1.000	0.800
0.150	1.000	0.800
0.160	1.000	0.800
0.170	1.000	0.800
0.180	1.000	0.800
0.200	1.000	0.800
0.250	1.000	0.800
0.300	1.000	0.800
0.400	1.000	0.800
0.500	1.000	0.800
0.600	1.000	0.800
0.640	1.000	0.800
0.750	0.907	0.725
0.850	0.800	0.640
0.900	0.756	0.604
0.950	0.716	0.573
1.000	0.680	0.544
1.500	0.453	0.363
2.000	0.340	0.272
3.000	0.227	0.181
4.000	0.170	0.136
5.000	0.136	0.109

**ASCE 7-16: Section 21.4
Site Specific**

	Calculated Value	Design Value
SDS:	1.060	1.060
SD1:	0.824	0.824
SMS:	1.590	1.590
SM1:	1.237	1.237
Site Specific PGAm:	0.603	0.603
Site Class:	D measured	

Seismic Design Category - Short* D

Seismic Design Category - 1s* D

* Risk Categories I, II, or III

Project No: 23756.1

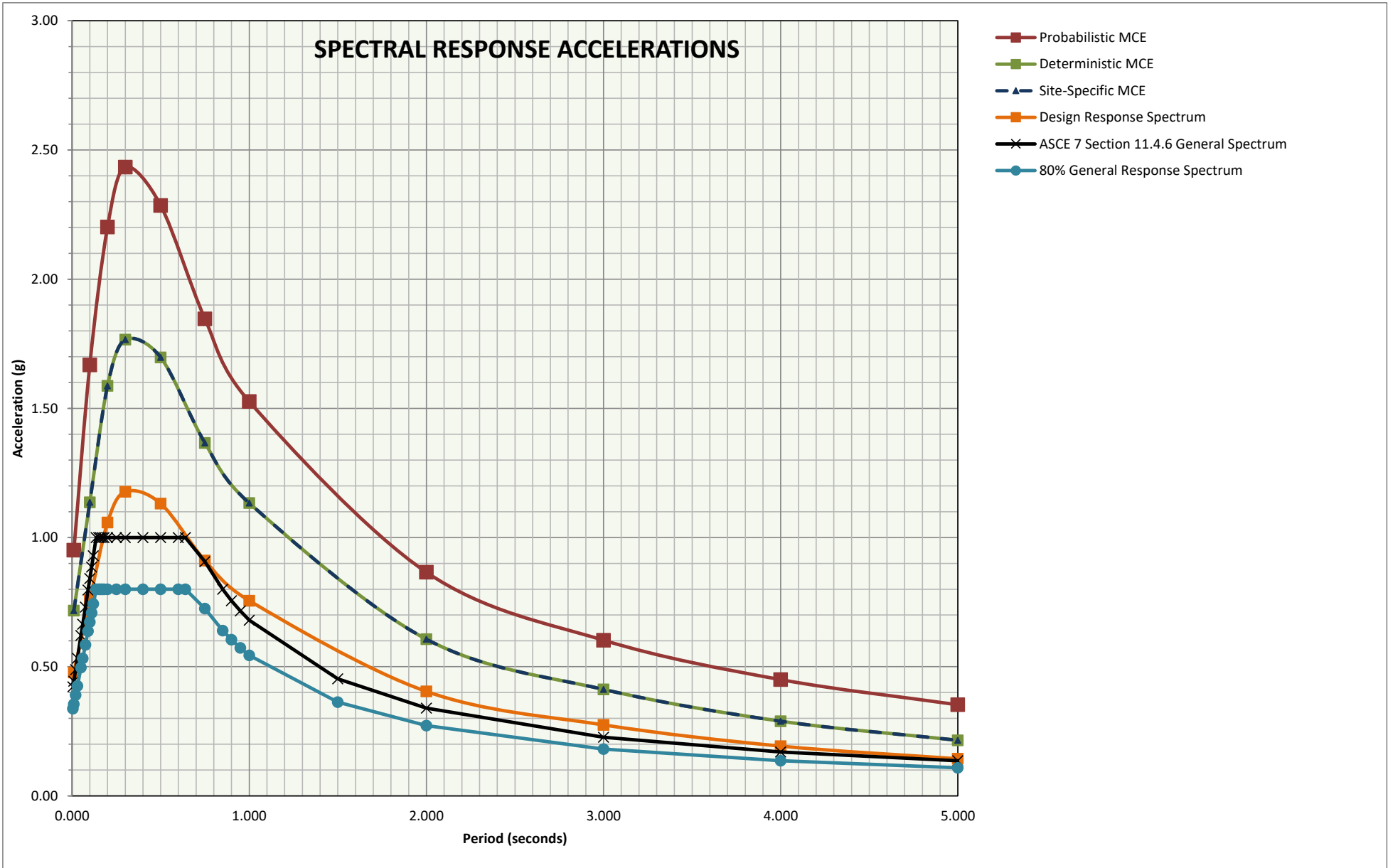

APPENDIX E

Infiltration Test Results

BOREHOLE METHOD PERCOLATION TEST RESULTS

Project: Old 215, Moreno Valley
 Project No.: 23756.1
 Soil Classification: (SM) Silty sand
 Depth of Test Hole: 7.0 ft.
 Tested By: A.L.

Test Date: September 8, 2021
 Test Hole No.: P-1
 Test Hole Diameter: 8.0 in.
 Date Excavated: September 7, 2021

READING	TIME START	TIME STOP	TIME INTERVAL		TOTAL TIME hr.	INITIAL WATER LEVEL in.	FINAL WATER LEVEL in.	INITIAL HOLE DEPTH in.	FINAL HOLE DEPTH in.	CHANGE IN WATER LEVEL in.	AVERAGE WETTED DEPTH in.	PERCOLATION RATE in/hr
			min	hr.								
1	9:10 AM	9:40 AM	30	0.50	0.50	23.00	23.50	84.00	84.00	0.50	60.75	1.0
2	9:40 AM	10:10 AM	30	0.50	1.00	23.50	23.50	84.00	84.00	0.00	60.50	0.0
3	10:10 AM	10:40 AM	30	0.50	1.50	23.50	24.00	84.00	84.00	0.50	60.25	1.0
4	10:40 AM	11:10 AM	30	0.50	2.00	24.00	24.50	84.00	84.00	0.50	59.75	1.0
5	11:10 AM	11:40 AM	30	0.50	2.50	24.50	25.00	84.00	84.00	0.50	59.25	1.0
6	11:40 AM	12:10 PM	30	0.50	3.00	25.00	25.50	84.00	84.00	0.50	58.75	1.0
7	12:10 PM	12:40 PM	30	0.50	3.50	25.50	26.00	84.00	84.00	0.50	58.25	1.0
8	12:40 PM	1:10 PM	30	0.50	4.00	26.00	26.50	84.00	84.00	0.50	57.75	1.0
9	1:10 PM	1:40 PM	30	0.50	4.50	26.50	27.00	84.00	84.00	0.50	57.25	1.0
10	1:40 PM	2:10 PM	30	0.50	5.00	27.00	27.50	84.00	84.00	0.50	56.75	1.0
11	2:10 PM	2:40 PM	30	0.50	5.50	27.50	28.00	84.00	84.00	0.50	56.25	1.0
12	2:40 PM	3:10 PM	30	0.50	6.00	28.00	28.50	84.00	84.00	0.50	55.75	1.0

PERCOLATION RATE CONVERSION (Porchet Method):

H_o 56.00
 H_f 55.50
 H 0.50
 H_{avg} 55.75
 I_t **0.03** in/hr (clear water rate)

BOREHOLE METHOD PERCOLATION TEST RESULTS

Project: Old 215, Moreno Valley
 Project No.: 23756.1
 Soil Classification: (SM) Silty sand
 Depth of Test Hole: 7.0 ft.
 Tested By: A.L.

Test Date: September 8, 2021
 Test Hole No.: P-2
 Test Hole Diameter: 8.0 in.
 Date Excavated: September 7, 2021

READING	TIME START	TIME STOP	TIME INTERVAL		TOTAL TIME hr.	INITIAL WATER LEVEL in.	FINAL WATER LEVEL in.	INITIAL HOLE DEPTH in.	FINAL HOLE DEPTH in.	CHANGE IN WATER LEVEL in.	AVERAGE WETTED DEPTH in.	PERCOLATION RATE in/hr
			min	hr.								
1	9:12 AM	9:42 AM	30	0.50	0.50	38.00	38.50	84.00	84.00	0.50	45.75	1.0
2	9:42 AM	10:12 AM	30	0.50	1.00	38.50	38.50	84.00	84.00	0.00	45.50	0.0
3	10:12 AM	10:42 AM	30	0.50	1.50	38.50	39.00	84.00	84.00	0.50	45.25	1.0
4	10:42 AM	11:12 AM	30	0.50	2.00	39.00	40.00	84.00	84.00	1.00	44.50	2.0
5	11:12 AM	11:42 AM	30	0.50	2.50	40.00	41.00	84.00	84.00	1.00	43.50	2.0
6	11:42 AM	12:12 PM	30	0.50	3.00	41.00	41.50	84.00	84.00	0.50	42.75	1.0
7	12:12 PM	12:42 PM	30	0.50	3.50	41.50	42.00	84.00	84.00	0.50	42.25	1.0
8	12:42 PM	1:12 PM	30	0.50	4.00	42.00	42.50	84.00	84.00	0.50	41.75	1.0
9	1:12 PM	1:42 PM	30	0.50	4.50	42.50	43.00	84.00	84.00	0.50	41.25	1.0
10	1:42 PM	2:12 PM	30	0.50	5.00	43.00	43.50	84.00	84.00	0.50	40.75	1.0
11	2:12 PM	2:42 PM	30	0.50	5.50	43.50	44.00	84.00	84.00	0.50	40.25	1.0
12	2:42 PM	3:12 PM	30	0.50	6.00	44.00	44.50	84.00	84.00	0.50	39.75	1.0

PERCOLATION RATE CONVERSION (Porchet Method):

H_o 40.00
 H_f 39.50
 H 0.50
 H_{avg} 39.75
 I_t **0.05** in/hr (clear water rate)

Appendix 4: Historical Site Conditions

Phase I Environmental Site Assessment or Other Information on Past Site Use

The project site is currently vacant and undeveloped. Topographically, site elevations range from approximately 1540.00 feet to 1526.00 feet above Mean Sea Level (MSL). The project site generally drains from the south to the north to Edgemont Channel at an approximate grade of 1.20%. A small area from the neighboring single family residences to the north is tributary to the project site. These flows will be honored, but will be left out of the pre and post development analysis.

Appendix 5: LID Infeasibility

LID Technical Infeasibility Analysis

Infiltration is not feasible on this site due to infiltration rates of 0.03 and 0.05 in/hr. Due to infiltration rates falling under the 1.6 in/hr threshold, infiltration is not feasible. Furthermore, due to infiltration rates falling under the 0.3 in/hr threshold, perforated underdrains are required in the bioswales, and a Modular Wetlands System is used to treat DMA 5.

Harvest and Use is not feasible on this site due to the limited landscaping on the property, thus not meeting Harvest and Use requirements.

Appendix 6: BMP Design Details

BMP Sizing, Design Details and other Supporting Documentation

Santa Ana Watershed - BMP Design Volume, V_{BMP}

(Rev. 10-2011)

Legend:

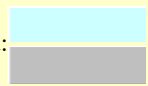

Required Entries

Calculated Cells

*(Note this worksheet shall **only** be used in conjunction with BMP designs from the **LID BMP Design Handbook**)*

Company Name	CASC	Date	3/17/2022
Designed by	CS	Case No	
Company Project Number/Name	Old 215 Industrial Buildings		

BMP Identification

BMP NAME / ID **BMP 1**

Must match Name/ID used on BMP Design Calculation Sheet

Design Rainfall Depth

85th Percentile, 24-hour Rainfall Depth, D_{85} = **0.62** inches
from the Isohyetal Map in Handbook Appendix E

Drainage Management Area Tabulation

Insert additional rows if needed to accommodate all DMAs draining to the BMP

DMA Type/ID	DMA Area (square feet)	Post-Project Surface Type	Effective Imperivous Fraction, I_f	DMA Runoff Factor	DMA Areas x Runoff Factor	Design Storm Depth (in)	Design Capture Volume, V_{BMP} (cubic feet)	Proposed Volume on Plans (cubic feet)
1A	3234	Ornamental Landscaping	0.1	0.11	357.2			
1B	6128	Concrete or Asphalt	1	0.89	5466.2			
9362		Total			5823.4	0.62	300.9	503.4

Notes:

Santa Ana Watershed - BMP Design Volume, V_{BMP}

(Rev. 10-2011)

Legend:

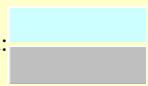

Required Entries

Calculated Cells

*(Note this worksheet shall **only** be used in conjunction with BMP designs from the **LID BMP Design Handbook**)*

Company Name **CASC** Date **3/17/2022**
 Designed by **CS** Case No _____
 Company Project Number/Name **Old 215 Industrial Buildings**

BMP Identification

BMP NAME / ID **BMP 2**
Must match Name/ID used on BMP Design Calculation Sheet

Design Rainfall Depth

85th Percentile, 24-hour Rainfall Depth, D_{85} = **0.62** inches
 from the Isohyetal Map in Handbook Appendix E

Drainage Management Area Tabulation

Insert additional rows if needed to accommodate all DMAs draining to the BMP

DMA Type/ID	DMA Area (square feet)	Post-Project Surface Type	Effective Imperivous Fraction, I_f	DMA Runoff Factor	DMA Areas x Runoff Factor	Design Storm Depth (in)	Design Capture Volume, V_{BMP} (cubic feet)	Proposed Volume on Plans (cubic feet)
2A	3768	Ornamental Landscaping	0.1	0.11	416.2			
2B	6372	Concrete or Asphalt	1	0.89	5683.8			
	10140		Total		6100	0.62	315.2	503.4

Notes:

Santa Ana Watershed - BMP Design Volume, V_{BMP}

(Rev. 10-2011)

Legend:

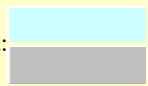

Required Entries

Calculated Cells

*(Note this worksheet shall **only** be used in conjunction with BMP designs from the **LID BMP Design Handbook**)*

Company Name **CASC** Date **3/17/2022**
 Designed by **CS** Case No _____
 Company Project Number/Name **Old 215 Industrial Buildings**

BMP Identification

BMP NAME / ID **BMP 3**

Must match Name/ID used on BMP Design Calculation Sheet

Design Rainfall Depth

85th Percentile, 24-hour Rainfall Depth, $D_{85} =$ **0.62** inches
 from the Isohyetal Map in Handbook Appendix E

Drainage Management Area Tabulation

Insert additional rows if needed to accommodate all DMAs draining to the BMP

DMA Type/ID	DMA Area (square feet)	Post-Project Surface Type	Effective Imperivous Fraction, I_f	DMA Runoff Factor	DMA Areas x Runoff Factor	Design Storm Depth (in)	Design Capture Volume, V_{BMP} (cubic feet)	Proposed Volume on Plans (cubic feet)
3A	1445	Ornamental Landscaping	0.1	0.11	159.6	0.62	280.2	521
3B	5900	Concrete or Asphalt	1	0.89	5262.8			
7345	Total				5422.4			

Notes:

Santa Ana Watershed - BMP Design Volume, V_{BMP}

(Rev. 10-2011)

Legend:

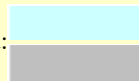

Required Entries

Calculated Cells

*(Note this worksheet shall **only** be used in conjunction with BMP designs from the **LID BMP Design Handbook**)*

Company Name **CASC** Date **3/17/2022**
 Designed by **CS** Case No _____
 Company Project Number/Name **Old 215 Industrial Buildings**

BMP Identification

BMP NAME / ID **BMP 4**

Must match Name/ID used on BMP Design Calculation Sheet

Design Rainfall Depth

85th Percentile, 24-hour Rainfall Depth, $D_{85} =$ **0.62** inches
 from the Isohyetal Map in Handbook Appendix E

Drainage Management Area Tabulation

Insert additional rows if needed to accommodate all DMAs draining to the BMP

DMA Type/ID	DMA Area (square feet)	Post-Project Surface Type	Effective Imperivous Fraction, I_f	DMA Runoff Factor	DMA Areas x Runoff Factor	Design Storm Depth (in)	Design Capture Volume, V_{BMP} (cubic feet)	Proposed Volume on Plans (cubic feet)
4A	507	Ornamental Landscaping	0.1	0.11	56			
4B	2070	Concrete or Asphalt	1	0.89	1846.4			
2577		Total			1902.4	0.62	98.3	189.7

Notes:

DCV Calcs

BMP 1 – Bioswale

BMP: Biotreatment with underdrain

$$\begin{aligned}SA_{\text{ponded}} &= 441.6 \text{ ft}^2 \\ \text{Length} &= 110.4 \text{ ft} \quad \text{Width} = 4 \text{ ft} \\ D_{\text{ponded}} &= 0.24 \text{ ft}\end{aligned}$$

$$\begin{aligned}SA_{\text{soil}} &= 441.6 \text{ ft}^2 \\ D_{\text{soil}} &= 3 \text{ ft} \\ N_{\text{soil}} &= 0.3\end{aligned}$$

$$\begin{aligned}V_{\text{ret}} &= 503.4 \text{ ft}^3 \\ \text{DCV} &= 300.9 \text{ ft}^3\end{aligned}$$

BMP 2 – Bioswale

BMP: Biotreatment with underdrain

$$\begin{aligned}SA_{\text{ponded}} &= 441.6 \text{ ft}^2 \\ \text{Length} &= 110.4 \text{ ft} \quad \text{Width} = 4 \text{ ft} \\ D_{\text{ponded}} &= 0.24 \text{ ft}\end{aligned}$$

$$\begin{aligned}SA_{\text{soil}} &= 441.6 \text{ ft}^2 \\ D_{\text{soil}} &= 3 \text{ ft} \\ N_{\text{soil}} &= 0.3\end{aligned}$$

$$\begin{aligned}V_{\text{ret}} &= 503.4 \text{ ft}^3 \\ \text{DCV} &= 315.2 \text{ ft}^3\end{aligned}$$

DCV Calcs

BMP 3 – Bioswale

BMP: Biotreatment with underdrain

$$\begin{aligned}SA_{\text{ponded}} &= 457 \text{ ft}^2 \\ \text{Length} &= 228.5 \text{ ft} \quad \text{Width} = 2 \text{ ft} \\ D_{\text{ponded}} &= 0.24 \text{ ft}\end{aligned}$$

$$\begin{aligned}SA_{\text{soil}} &= 457 \text{ ft}^2 \\ D_{\text{soil}} &= 3 \text{ ft} \\ N_{\text{soil}} &= 0.3\end{aligned}$$

$$\begin{aligned}V_{\text{ret}} &= 521.0 \text{ ft}^3 \\ \text{DCV} &= 280.2 \text{ ft}^3\end{aligned}$$

BMP 4 – Bioswale

BMP: Biotreatment with underdrain

$$\begin{aligned}SA_{\text{ponded}} &= 166.4 \text{ ft}^2 \\ \text{Length} &= 83.2 \text{ ft} \quad \text{Width} = 2 \text{ ft} \\ D_{\text{ponded}} &= 0.24 \text{ ft}\end{aligned}$$

$$\begin{aligned}SA_{\text{soil}} &= 166.4 \text{ ft}^2 \\ D_{\text{soil}} &= 3 \text{ ft} \\ N_{\text{soil}} &= 0.3\end{aligned}$$

$$\begin{aligned}V_{\text{ret}} &= 189.7 \text{ ft}^3 \\ \text{DCV} &= 98.3 \text{ ft}^3\end{aligned}$$

APPENDIX B – UNDERDRAINS

Where underdrains are specified, the following information provides guidance for underdrain requirements.

Underdrain Material Types

Underdrain pipe shall be 6-inch diameter ABS pipe or PVC pipe. ABS pipe shall meet the requirements of ASTM Designation D-2751, SDR 23.5, and PVC pipe shall meet the requirements of ASTM Designation D-2665. Perforations shall be as described in ASTM Designation C-700. It should be noted that placing the pipe such that the perforations are oriented upward may help to maximize infiltration in unlined BMP's with underdrains. If the BMP is constructed with an impermeable liner, the perforations should be angled downward to maximize the volume of water that will be drained from the BMP.

Underdrain Connections

Pipe joints and storm drain structure connections must be adequately sealed to avoid piping conditions (water seeping through pipe or structure joints). Pipe sections shall be coupled using suitable connection rings and flanges. Field connections to storm drain structures and pipes shall be sealed with polymer grout material that is capable of adhering to surfaces. Underdrain pipe shall be capped (at structure) until completion of site construction. Underdrains connected directly to a storm drainage structure shall be non-perforated for an appropriate distance from the structure interface to avoid possible piping problems.

Underdrain Slope

Underdrains must "daylight" or connect to an existing drainage system to achieve positive flow. All underdrains must be placed with a minimum slope of 0.5% ($s = 0.005$ ft/ft).

Underdrains Layout and Spacing

Typically, there are two main layouts for underdrains. One is a non-perforated central collector pipe with perforated lateral feeder pipes, the other is simply a series of longitudinal perforated pipes. Both layouts connect to a non-perforated outlet pipe before "daylighting" or connecting to an existing drainage system. The minimum spacing is shown below.

BMP Type	Underdrains Center to Center Spacing
Sand Filter Basin	20'
Extended Detention Basins (Bottom stage 500 sq ft. or greater)	20'
Extended Detention Basins (Bottom stage < 500 sq ft.)	10'
Bioretention Facility	5'

Underdrain Gravel

Gravel bed materials should be used to protect an underdrain pipe and to reduce clogging potential. Placement of gravel over the underdrain must be done with care. Avoid dropping the gravel from excessive heights from a backhoe or front-end loader bucket. Spill directly over underdrain and spread manually.

Recommended construction specifications for gravel used to protect underdrains are as follows:

- AASHTO #57 stone preferred
- Geotextile fabrics should be avoided because tearing and/or plugging can dramatically affect performance. If the designer is concerned about the engineered soil media migrating into the underdrain, a 3-inch thick layer of "pea gravel" may be added to create a "choker" course.

Maintenance

Access for cleaning underdrains is required for each system. Clean-outs, with diameters equal to the underdrain, should extend 6 inches above the media and have a lockable screw cap for easy access. Cleanouts should be located for every 50 feet of lateral, at the collector drain line connection, and at any bends.

Underdrain Orifice Plate

When designing a BMP to meet Hydraulic Conditions of Concern (HCO) criteria in addition to water quality criteria, it is sometimes necessary to install an orifice plate near the downstream end of the underdrain system. The orifice plate restricts the opening of the underdrain to mitigate flows to a specific lower flow threshold. Proper maintenance access should be provided to the orifice plate location to facilitate maintenance activities, specifically the removal of accumulated sediment and debris upstream of the orifice plate.

Santa Ana Watershed - BMP Design Volume, V_{BMP}

(Rev. 10-2011)

Legend:

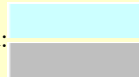

Required Entries

Calculated Cells

*(Note this worksheet shall **only** be used in conjunction with BMP designs from the **LID BMP Design Handbook**)*

Company Name **CASC** Date **3/17/2022**
 Designed by **CS** Case No _____
 Company Project Number/Name **Old 215 Industrial Buildings**

BMP Identification

BMP NAME / ID **BMP 5**

Must match Name/ID used on BMP Design Calculation Sheet

Design Rainfall Depth

85th Percentile, 24-hour Rainfall Depth, $D_{85} =$ **0.62** inches
 from the Isohyetal Map in Handbook Appendix E

Drainage Management Area Tabulation



Insert additional rows if needed to accommodate all DMAs draining to the BMP

DMA Type/ID	DMA Area (square feet)	Post-Project Surface Type	Effective Imperivous Fraction, I_f	DMA Runoff Factor	DMA Areas x Runoff Factor	Design Storm Depth (in)	Design Capture Volume, V_{BMP} (cubic feet)	Proposed Volume on Plans (cubic feet)
5A	41678	Ornamental Landscaping	0.1	0.11	4603.7			
5B	100160	Roofs	1	0.89	89342.7			
5C	215467	Concrete or Asphalt	1	0.89	192196.6			
Total					286143	0.62	14784.1	15227.5

Notes:

ADS & MWS Calculations

System:

ADS Chambers  Pump  MWS L-8-8-V

Runoff will be stored in the ADS Chamber, then gravity flow to the proposed pump. The pump will then raise the runoff to the MWS, which it will then gravity flow through the MWS and into the proposed outlet storm drain system. Under high flow conditions, runoff will bypass the MWS and go directly into the proposed outlet storm drain system.

Drainage of ADS system:

Volume of ADS = 15,230 CF

MWS Flowrate = 0.23 CFS

$$15,230 \text{ CF} / 0.23 \text{ CFS} = 66,217.39 \text{ S}$$

$$66,217.39 \text{ S} / 3600 \text{ S/Hr} = 18.39 \text{ Hrs.}$$

A total system volume of 15,230 CF will drain within 19 Hours. Thus meeting the 72 Hour requirement.

User Inputs

Chamber Model:	MC-3500
Outlet Control Structure:	Yes
Project Name:	Old 215
Engineer:	Chris Sidor
Project Location:	California
Measurement Type:	Imperial
Required Storage Volume:	14800 cubic ft.
Stone Porosity:	40%
Stone Foundation Depth:	9 in.
Stone Above Chambers:	12 in.
Average Cover Over Chambers:	18 in.
Design Constraint Dimensions:	(200 ft. x 100 ft.)

Results

System Volume and Bed Size

Installed Storage Volume:	15227.57 cubic ft.
Storage Volume Per Chamber:	109.90 cubic ft.
Number Of Chambers Required:	78
Number Of End Caps Required:	14
Chamber Rows:	7
Maximum Length:	95.88 ft.
Maximum Width:	50.52 ft.
Approx. Bed Size Required:	4526.86 square ft.

System Components

Amount Of Stone Required:	596.92 cubic yards
Volume Of Excavation (Not Including Fill):	922.14 cubic yards
Total Non-woven Geotextile Required:	1427.94 square yards
Woven Geotextile Required (excluding Isolator Row):	66.92 square yards
Woven Geotextile Required (Isolator Row):	104.71 square yards
Total Woven Geotextile Required:	171.63 square yards

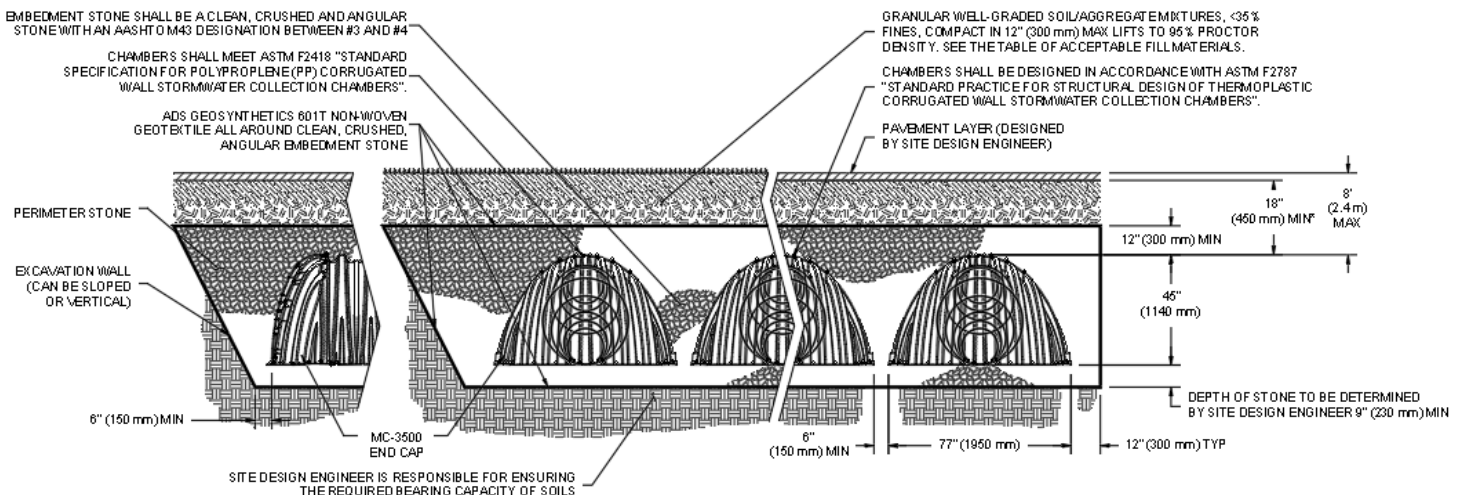

*MINIMUM COVER TO BOTTOM OF FLEXIBLE PAVEMENT. FOR UNPAVED INSTALLATIONS WHERE RUTTING FROM VEHICLES MAY OCCUR, INCREASE COVER TO 24"

PROJECT INFORMATION	
ENGINEERED PRODUCT MANAGER	
ADS SALES REP	
PROJECT NO.	



SiteASSIST™
FOR STORMTECH
INSTRUCTIONS,
DOWNLOAD THE
INSTALLATION APP



OLD 215 MORENO VALLEY, CA

MC-3500 STORMTECH CHAMBER SPECIFICATIONS

1. CHAMBERS SHALL BE STORMTECH MC-3500.
2. CHAMBERS SHALL BE ARCH-SHAPED AND SHALL BE MANUFACTURED FROM VIRGIN, IMPACT-MODIFIED POLYPROPYLENE COPOLYMERS.
3. CHAMBERS SHALL MEET THE REQUIREMENTS OF ASTM F2418-16a, "STANDARD SPECIFICATION FOR POLYPROPYLENE (PP) CORRUGATED WALL STORMWATER COLLECTION CHAMBERS" CHAMBER CLASSIFICATION 45x76 DESIGNATION SS.
4. CHAMBER ROWS SHALL PROVIDE CONTINUOUS, UNOBSTRUCTED INTERNAL SPACE WITH NO INTERNAL SUPPORTS THAT WOULD IMPEDE FLOW OR LIMIT ACCESS FOR INSPECTION.
5. THE STRUCTURAL DESIGN OF THE CHAMBERS, THE STRUCTURAL BACKFILL, AND THE INSTALLATION REQUIREMENTS SHALL ENSURE THAT THE LOAD FACTORS SPECIFIED IN THE AASHTO LRFD BRIDGE DESIGN SPECIFICATIONS, SECTION 12.12, ARE MET FOR: 1) LONG-DURATION DEAD LOADS AND 2) SHORT-DURATION LIVE LOADS, BASED ON THE AASHTO DESIGN TRUCK WITH CONSIDERATION FOR IMPACT AND MULTIPLE VEHICLE PRESENCES.
6. CHAMBERS SHALL BE DESIGNED, TESTED AND ALLOWABLE LOAD CONFIGURATIONS DETERMINED IN ACCORDANCE WITH ASTM F2787, "STANDARD PRACTICE FOR STRUCTURAL DESIGN OF THERMOPLASTIC CORRUGATED WALL STORMWATER COLLECTION CHAMBERS". LOAD CONFIGURATIONS SHALL INCLUDE: 1) INSTANTANEOUS (<1 MIN) AASHTO DESIGN TRUCK LIVE LOAD ON MINIMUM COVER 2) MAXIMUM PERMANENT (75-YR) COVER LOAD AND 3) ALLOWABLE COVER WITH PARKED (1-WEEK) AASHTO DESIGN TRUCK.
7. REQUIREMENTS FOR HANDLING AND INSTALLATION:
 - TO MAINTAIN THE WIDTH OF CHAMBERS DURING SHIPPING AND HANDLING, CHAMBERS SHALL HAVE INTEGRAL, INTERLOCKING STACKING LUGS.
 - TO ENSURE A SECURE JOINT DURING INSTALLATION AND BACKFILL, THE HEIGHT OF THE CHAMBER JOINT SHALL NOT BE LESS THAN 3".
 - TO ENSURE THE INTEGRITY OF THE ARCH SHAPE DURING INSTALLATION, a) THE ARCH STIFFNESS CONSTANT AS DEFINED IN SECTION 6.2.8 OF ASTM F2418 SHALL BE GREATER THAN OR EQUAL TO 500 LBS/IN/IN. AND b) TO RESIST CHAMBER DEFORMATION DURING INSTALLATION AT ELEVATED TEMPERATURES (ABOVE 73° F / 23° C), CHAMBERS SHALL BE PRODUCED FROM REFLECTIVE GOLD OR YELLOW COLORS.
8. ONLY CHAMBERS THAT ARE APPROVED BY THE SITE DESIGN ENGINEER WILL BE ALLOWED. UPON REQUEST BY THE SITE DESIGN ENGINEER OR OWNER, THE CHAMBER MANUFACTURER SHALL SUBMIT A STRUCTURAL EVALUATION FOR APPROVAL BEFORE DELIVERING CHAMBERS TO THE PROJECT SITE AS FOLLOWS:
 - THE STRUCTURAL EVALUATION SHALL BE SEALED BY A REGISTERED PROFESSIONAL ENGINEER.
 - THE STRUCTURAL EVALUATION SHALL DEMONSTRATE THAT THE SAFETY FACTORS ARE GREATER THAN OR EQUAL TO 1.95 FOR DEAD LOAD AND 1.75 FOR LIVE LOAD, THE MINIMUM REQUIRED BY ASTM F2787 AND BY SECTIONS 3 AND 12.12 OF THE AASHTO LRFD BRIDGE DESIGN SPECIFICATIONS FOR THERMOPLASTIC PIPE.
 - THE TEST DERIVED CREEP MODULUS AS SPECIFIED IN ASTM F2418 SHALL BE USED FOR PERMANENT DEAD LOAD DESIGN EXCEPT THAT IT SHALL BE THE 75-YEAR MODULUS USED FOR DESIGN.
9. CHAMBERS AND END CAPS SHALL BE PRODUCED AT AN ISO 9001 CERTIFIED MANUFACTURING FACILITY.

IMPORTANT - NOTES FOR THE BIDDING AND INSTALLATION OF MC-3500 CHAMBER SYSTEM

1. STORMTECH MC-3500 CHAMBERS SHALL NOT BE INSTALLED UNTIL THE MANUFACTURER'S REPRESENTATIVE HAS COMPLETED A PRE-CONSTRUCTION MEETING WITH THE INSTALLERS.
2. STORMTECH MC-3500 CHAMBERS SHALL BE INSTALLED IN ACCORDANCE WITH THE "STORMTECH MC-3500/MC-4500 CONSTRUCTION GUIDE".
3. CHAMBERS ARE NOT TO BE BACKFILLED WITH A DOZER OR AN EXCAVATOR SITUATED OVER THE CHAMBERS. STORMTECH RECOMMENDS 3 BACKFILL METHODS:
 - STONESHOOTER LOCATED OFF THE CHAMBER BED.
 - BACKFILL AS ROWS ARE BUILT USING AN EXCAVATOR ON THE FOUNDATION STONE OR SUBGRADE.
 - BACKFILL FROM OUTSIDE THE EXCAVATION USING A LONG BOOM HOE OR EXCAVATOR.
4. THE FOUNDATION STONE SHALL BE LEVELED AND COMPACTED PRIOR TO PLACING CHAMBERS.
5. JOINTS BETWEEN CHAMBERS SHALL BE PROPERLY SEATED PRIOR TO PLACING STONE.
6. MAINTAIN MINIMUM - 6" (150 mm) SPACING BETWEEN THE CHAMBER ROWS.
7. INLET AND OUTLET MANIFOLDS MUST BE INSERTED A MINIMUM OF 12" (300 mm) INTO CHAMBER END CAPS.
8. EMBEDMENT STONE SURROUNDING CHAMBERS MUST BE A CLEAN, CRUSHED, ANGULAR STONE MEETING THE AASHTO M43 DESIGNATION OF #3 OR #4.
9. STONE MUST BE PLACED ON THE TOP CENTER OF THE CHAMBER TO ANCHOR THE CHAMBERS IN PLACE AND PRESERVE ROW SPACING.
10. THE CONTRACTOR MUST REPORT ANY DISCREPANCIES WITH CHAMBER FOUNDATION MATERIALS BEARING CAPACITIES TO THE SITE DESIGN ENGINEER.
11. ADS RECOMMENDS THE USE OF "FLEXSTORM CATCH IT" INSERTS DURING CONSTRUCTION FOR ALL INLETS TO PROTECT THE SUBSURFACE STORMWATER MANAGEMENT SYSTEM FROM CONSTRUCTION SITE RUNOFF.

NOTES FOR CONSTRUCTION EQUIPMENT

1. STORMTECH MC-3500 CHAMBERS SHALL BE INSTALLED IN ACCORDANCE WITH THE "STORMTECH MC-3500/MC-4500 CONSTRUCTION GUIDE".
2. THE USE OF EQUIPMENT OVER MC-3500 CHAMBERS IS LIMITED:
 - NO EQUIPMENT IS ALLOWED ON BARE CHAMBERS.
 - NO RUBBER TIRED LOADER, DUMP TRUCK, OR EXCAVATORS ARE ALLOWED UNTIL PROPER FILL DEPTHS ARE REACHED IN ACCORDANCE WITH THE "STORMTECH MC-3500/MC-4500 CONSTRUCTION GUIDE".
 - WEIGHT LIMITS FOR CONSTRUCTION EQUIPMENT CAN BE FOUND IN THE "STORMTECH MC-3500/MC-4500 CONSTRUCTION GUIDE".
3. FULL 36" (900 mm) OF STABILIZED COVER MATERIALS OVER THE CHAMBERS IS REQUIRED FOR DUMP TRUCK TRAVEL OR DUMPING.

USE OF A DOZER TO PUSH EMBEDMENT STONE BETWEEN THE ROWS OF CHAMBERS MAY CAUSE DAMAGE TO CHAMBERS AND IS NOT AN ACCEPTABLE BACKFILL METHOD. ANY CHAMBERS DAMAGED BY USING THE "DUMP AND PUSH" METHOD ARE NOT COVERED UNDER THE STORMTECH STANDARD WARRANTY.

CONTACT STORMTECH AT 1-888-892-2694 WITH ANY QUESTIONS ON INSTALLATION REQUIREMENTS OR WEIGHT LIMITS FOR CONSTRUCTION EQUIPMENT.

PROPOSED LAYOUT		CONCEPTUAL ELEVATIONS		*INVERT ABOVE BASE OF CHAMBER				
				PART TYPE	ITEM ON LAYOUT	DESCRIPTION	INVERT*	MAX FLOW
78	STORMTECH MC-3500 CHAMBERS	MAXIMUM ALLOWABLE GRADE (TOP OF PAVEMENT/UNPAVED):	12.50					
14	STORMTECH MC-3500 END CAPS	MINIMUM ALLOWABLE GRADE (UNPAVED WITH TRAFFIC):	6.50					
12	STONE ABOVE (in)	MINIMUM ALLOWABLE GRADE (UNPAVED NO TRAFFIC):	6.00	PREFABRICATED END CAP	A	24" BOTTOM CORED END CAP, PART#: MC3500IEPP24BC / TYP OF ALL 24" BOTTOM CONNECTIONS AND ISOLATOR PLUS ROWS	2.06"	
9	STONE BELOW (in)	MINIMUM ALLOWABLE GRADE (TOP OF RIGID CONCRETE PAVEMENT):	6.00					
40	STONE VOID	MINIMUM ALLOWABLE GRADE (BASE OF FLEXIBLE PAVEMENT):	6.00	PREFABRICATED END CAP	B	18" BOTTOM CORED END CAP, PART#: MC3500IEPP18BC / TYP OF ALL 18" BOTTOM CONNECTIONS	1.77"	
15230	INSTALLED SYSTEM VOLUME (CF) (PERIMETER STONE INCLUDED) (COVER STONE INCLUDED) (BASE STONE INCLUDED)	TOP OF STONE:	5.50	FLAMP	C	INSTALL FLAMP ON 24" ACCESS PIPE / PART#: MC350024RAMP (TYP 2 PLACES)		
		TOP OF MC-3500 CHAMBER:	4.50	MANIFOLD	D	18" x 18" BOTTOM MANIFOLD, ADS N-12	1.77"	
		24" ISOLATOR ROW PLUS INVERT:	0.92	MANIFOLD	E	18" x 18" BOTTOM MANIFOLD, ADS N-12	1.77"	
		18" x 18" BOTTOM MANIFOLD INVERT:	0.90	CONCRETE STRUCTURE	F	OCS (DESIGN BY ENGINEER / PROVIDED BY OTHERS)		8.0 CFS OUT
4527	SYSTEM AREA (SF)	18" x 18" BOTTOM MANIFOLD INVERT:	0.90	CONCRETE STRUCTURE	G	(DESIGN BY ENGINEER / PROVIDED BY OTHERS)		20.9 CFS IN
301.1	SYSTEM PERIMETER (ft)	18" BOTTOM CONNECTION INVERT:	0.90	UNDERDRAIN	H	6" ADS N-12 DUAL WALL PERFORATED HDPE UNDERDRAIN		
		BOTTOM OF MC-3500 CHAMBER:	0.75					
		UNDERDRAIN INVERT:	0.00					
		BOTTOM OF STONE:	0.00					



- ISOLATOR ROW PLUS (SEE DETAIL)
- PLACE MINIMUM 17.50' OF ADSPLUS175 WOVEN GEOTEXTILE OVER BEDDING STONE AND UNDERNEATH CHAMBER FEET FOR SCOUR PROTECTION AT ALL CHAMBER INLET ROWS
- BED LIMITS

NOTES

- MANIFOLD SIZE TO BE DETERMINED BY SITE DESIGN ENGINEER. SEE TECH NOTE #6.32 FOR MANIFOLD SIZING GUIDANCE.
- DUE TO THE ADAPTATION OF THIS CHAMBER SYSTEM TO SPECIFIC SITE AND DESIGN CONSTRAINTS, IT MAY BE NECESSARY TO CUT AND COUPLE ADDITIONAL PIPE TO STANDARD MANIFOLD COMPONENTS IN THE FIELD.
- THE SITE DESIGN ENGINEER MUST REVIEW ELEVATIONS AND IF NECESSARY ADJUST GRADING TO ENSURE THE CHAMBER COVER REQUIREMENTS ARE MET.
- THIS CHAMBER SYSTEM WAS DESIGNED WITHOUT SITE-SPECIFIC INFORMATION ON SOIL CONDITIONS OR BEARING CAPACITY. THE SITE DESIGN ENGINEER IS RESPONSIBLE FOR DETERMINING THE SUITABILITY OF THE SOIL AND PROVIDING THE BEARING CAPACITY OF THE INSITU SOILS. THE BASE STONE DEPTH MAY BE INCREASED OR DECREASED ONCE THIS INFORMATION IS PROVIDED.
- **NOT FOR CONSTRUCTION:** THIS LAYOUT IS FOR DIMENSIONAL PURPOSES ONLY TO PROVE CONCEPT & THE REQUIRED STORAGE VOLUME CAN BE ACHIEVED ON SITE.

StormTech®
Chamber System

888-892-2694 | WWW.STORMTECH.COM

4640 TRUEMAN BLVD
HILLIARD, OH 43026
1-800-733-7473

0 10' 20'

OLD 125

MORENO VALLEY, CA

DATE:

PROJECT #:

DRAWN: CS

CHECKED: N/A

DATE	CHK	DRW	CHK	DESCRIPTION

SHEET

2 OF 5

THIS DRAWING HAS BEEN PREPARED BASED ON INFORMATION PROVIDED TO ADS UNDER THE DIRECTION OF THE SITE DESIGN ENGINEER OR OTHER PROJECT REPRESENTATIVE. THE SITE DESIGN ENGINEER SHALL REVIEW THIS DRAWING PRIOR TO CONSTRUCTION. IT IS THE ULTIMATE RESPONSIBILITY OF THE SITE DESIGN ENGINEER TO ENSURE THAT THE PRODUCT(S) DEPICTED AND ALL ASSOCIATED DETAILS MEET ALL APPLICABLE LAWS, REGULATIONS, AND PROJECT REQUIREMENTS.

ACCEPTABLE FILL MATERIALS: STORMTECH MC-3500 CHAMBER SYSTEMS

MATERIAL LOCATION		DESCRIPTION	AASHTO MATERIAL CLASSIFICATIONS	COMPACTION / DENSITY REQUIREMENT
D	FINAL FILL: FILL MATERIAL FOR LAYER 'D' STARTS FROM THE TOP OF THE 'C' LAYER TO THE BOTTOM OF FLEXIBLE PAVEMENT OR UNPAVED FINISHED GRADE ABOVE. NOTE THAT PAVEMENT SUBBASE MAY BE PART OF THE 'D' LAYER	ANY SOIL/ROCK MATERIALS, NATIVE SOILS, OR PER ENGINEER'S PLANS. CHECK PLANS FOR PAVEMENT SUBGRADE REQUIREMENTS.	N/A	PREPARE PER SITE DESIGN ENGINEER'S PLANS. PAVED INSTALLATIONS MAY HAVE STRINGENT MATERIAL AND PREPARATION REQUIREMENTS.
C	INITIAL FILL: FILL MATERIAL FOR LAYER 'C' STARTS FROM THE TOP OF THE EMBEDMENT STONE ('B' LAYER) TO 24" (600 mm) ABOVE THE TOP OF THE CHAMBER. NOTE THAT PAVEMENT SUBBASE MAY BE A PART OF THE 'C' LAYER.	GRANULAR WELL-GRADED SOIL/AGGREGATE MIXTURES, <35% FINES OR PROCESSED AGGREGATE. MOST PAVEMENT SUBBASE MATERIALS CAN BE USED IN LIEU OF THIS LAYER.	AASHTO M145 ¹ A-1, A-2-4, A-3 OR AASHTO M43 ¹ 3, 357, 4, 467, 5, 56, 57, 6, 67, 68, 7, 78, 8, 89, 9, 10	BEGIN COMPACTIONS AFTER 24" (600 mm) OF MATERIAL OVER THE CHAMBERS IS REACHED. COMPACT ADDITIONAL LAYERS IN 12" (300 mm) MAX LIFTS TO A MIN. 95% PROCTOR DENSITY FOR WELL GRADED MATERIAL AND 95% RELATIVE DENSITY FOR PROCESSED AGGREGATE MATERIALS.
B	EMBEDMENT STONE: FILL SURROUNDING THE CHAMBERS FROM THE FOUNDATION STONE ('A' LAYER) TO THE 'C' LAYER ABOVE.	CLEAN, CRUSHED, ANGULAR STONE	AASHTO M43 ¹ 3, 4	NO COMPACTION REQUIRED.
A	FOUNDATION STONE: FILL BELOW CHAMBERS FROM THE SUBGRADE UP TO THE FOOT (BOTTOM) OF THE CHAMBER.	CLEAN, CRUSHED, ANGULAR STONE	AASHTO M43 ¹ 3, 4	PLATE COMPACT OR ROLL TO ACHIEVE A FLAT SURFACE. ^{2,3}

PLEASE NOTE:

- THE LISTED AASHTO DESIGNATIONS ARE FOR GRADATIONS ONLY. THE STONE MUST ALSO BE CLEAN, CRUSHED, ANGULAR. FOR EXAMPLE, A SPECIFICATION FOR #4 STONE WOULD STATE: "CLEAN, CRUSHED, ANGULAR NO. 4 (AASHTO M43) STONE".
- STORMTECH COMPACTION REQUIREMENTS ARE MET FOR 'A' LOCATION MATERIALS WHEN PLACED AND COMPACTED IN 9" (230 mm) (MAX) LIFTS USING TWO FULL COVERAGES WITH A VIBRATORY COMPACTOR.
- WHERE INFILTRATION SURFACES MAY BE COMPROMISED BY COMPACTION, FOR STANDARD DESIGN LOAD CONDITIONS, A FLAT SURFACE MAY BE ACHIEVED BY RAKING OR DRAGGING WITHOUT COMPACTION EQUIPMENT. FOR SPECIAL LOAD DESIGNS, CONTACT STORMTECH FOR COMPACTION REQUIREMENTS.
- ONCE LAYER 'C' IS PLACED, ANY SOIL/MATERIAL CAN BE PLACED IN LAYER 'D' UP TO THE FINISHED GRADE. MOST PAVEMENT SUBBASE SOILS CAN BE USED TO REPLACE THE MATERIAL REQUIREMENTS OF LAYER 'C' OR 'D' AT THE SITE DESIGN ENGINEER'S DISCRETION.

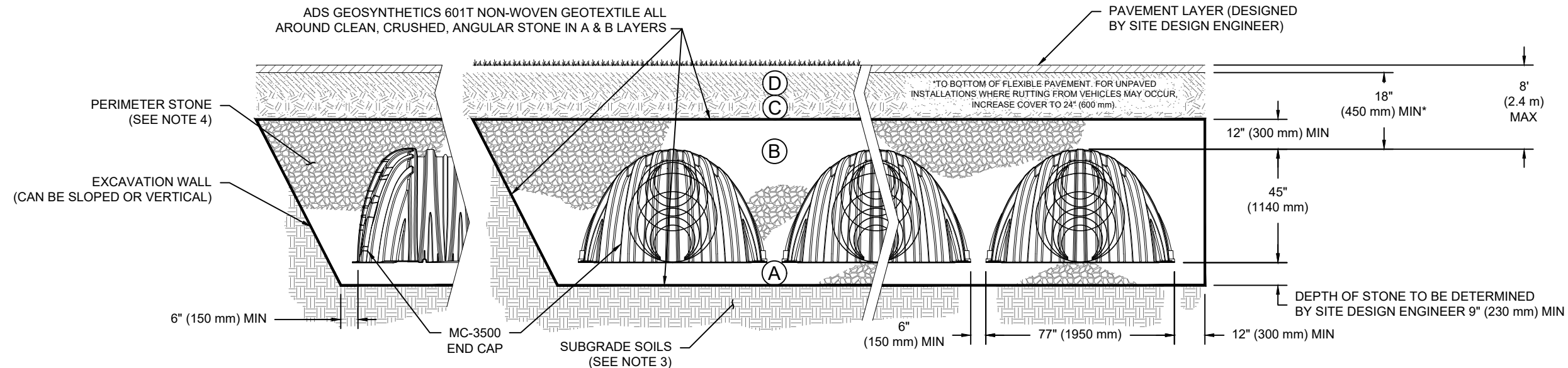

NOTES:

- CHAMBERS SHALL MEET THE REQUIREMENTS OF ASTM F2418-16a, "STANDARD SPECIFICATION FOR POLYPROPYLENE (PP) CORRUGATED WALL STORMWATER COLLECTION CHAMBERS" CHAMBER CLASSIFICATION 45x76 DESIGNATION SS.
- MC-3500 CHAMBERS SHALL BE DESIGNED IN ACCORDANCE WITH ASTM F2787 "STANDARD PRACTICE FOR STRUCTURAL DESIGN OF THERMOPLASTIC CORRUGATED WALL STORMWATER COLLECTION CHAMBERS".
- THE SITE DESIGN ENGINEER IS RESPONSIBLE FOR ASSESSING THE BEARING RESISTANCE (ALLOWABLE BEARING CAPACITY) OF THE SUBGRADE SOILS AND THE DEPTH OF FOUNDATION STONE WITH CONSIDERATION FOR THE RANGE OF EXPECTED SOIL MOISTURE CONDITIONS.
- PERIMETER STONE MUST BE EXTENDED HORIZONTALLY TO THE EXCAVATION WALL FOR BOTH VERTICAL AND SLOPED EXCAVATION WALLS.
- REQUIREMENTS FOR HANDLING AND INSTALLATION:
 - TO MAINTAIN THE WIDTH OF CHAMBERS DURING SHIPPING AND HANDLING, CHAMBERS SHALL HAVE INTEGRAL, INTERLOCKING STACKING LUGS.
 - TO ENSURE A SECURE JOINT DURING INSTALLATION AND BACKFILL, THE HEIGHT OF THE CHAMBER JOINT SHALL NOT BE LESS THAN 3".
 - TO ENSURE THE INTEGRITY OF THE ARCH SHAPE DURING INSTALLATION, a) THE ARCH STIFFNESS CONSTANT AS DEFINED IN SECTION 6.2.8 OF ASTM F2418 SHALL BE GREATER THAN OR EQUAL TO 500 LBS/IN/IN. AND b) TO RESIST CHAMBER DEFORMATION DURING INSTALLATION AT ELEVATED TEMPERATURES (ABOVE 73° F / 23° C), CHAMBERS SHALL BE PRODUCED FROM REFLECTIVE GOLD OR YELLOW COLORS.

OLD 215

MORENO VALLEY, CA

DRAWN: CS

CHECKED: N/A

DATE:

PROJECT #:

DESCRIPTION

CHK

DRW

DATE

DATE

StormTech®
Chamber System

888-892-2694 | WWW.STORMTECH.COM

4640 TRUEMAN BLVD
HILLIARD, OH 43026
1-800-733-7473



THIS DRAWING HAS BEEN PREPARED BASED ON INFORMATION PROVIDED TO ADS UNDER THE DIRECTION OF THE SITE DESIGN ENGINEER OR OTHER PROJECT REPRESENTATIVE. THE SITE DESIGN ENGINEER SHALL REVIEW THIS DRAWING PRIOR TO CONSTRUCTION. IT IS THE ULTIMATE RESPONSIBILITY OF THE SITE DESIGN ENGINEER TO ENSURE THAT THE PRODUCT(S) DEPICTED AND ALL ASSOCIATED DETAILS MEET ALL APPLICABLE LAWS, REGULATIONS, AND PROJECT REQUIREMENTS.

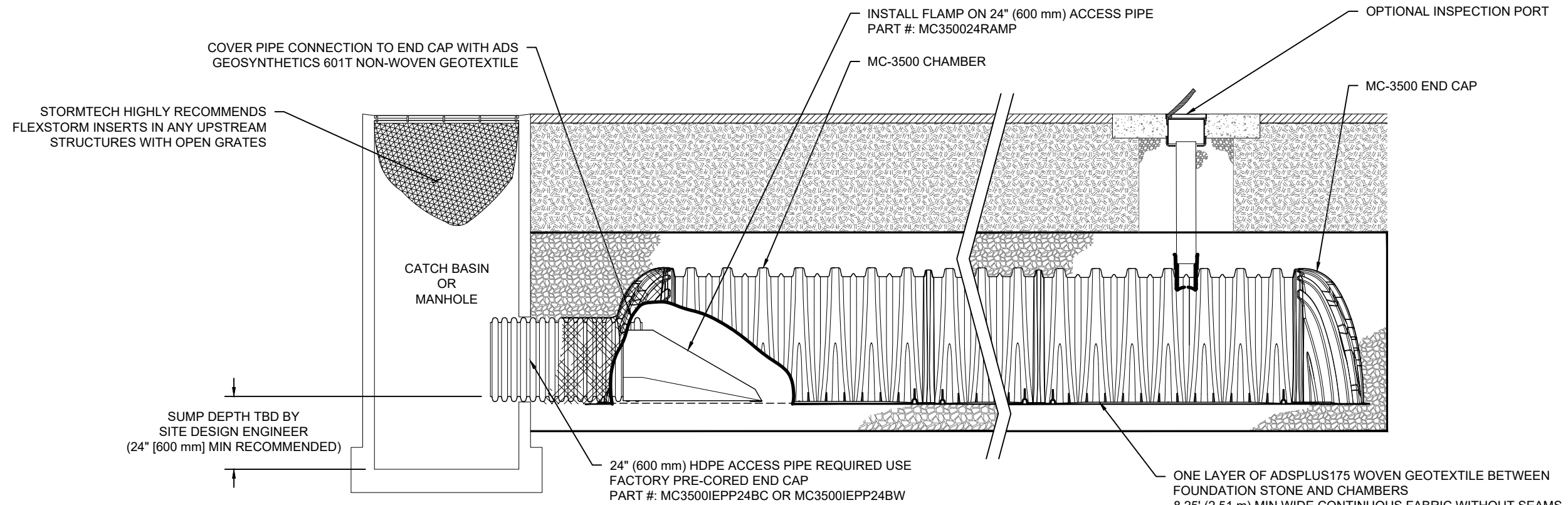

MC-3500 ISOLATOR ROW PLUS DETAIL

NTS

INSPECTION & MAINTENANCE

- STEP 1) INSPECT ISOLATOR ROW PLUS FOR SEDIMENT
- A. INSPECTION PORTS (IF PRESENT)
 - A.1. REMOVE/OPEN LID ON NYLOPLAST INLINE DRAIN
 - A.2. REMOVE AND CLEAN FLEXSTORM FILTER IF INSTALLED
 - A.3. USING A FLASHLIGHT AND STADIA ROD, MEASURE DEPTH OF SEDIMENT AND RECORD ON MAINTENANCE LOG
 - A.4. LOWER A CAMERA INTO ISOLATOR ROW PLUS FOR VISUAL INSPECTION OF SEDIMENT LEVELS (OPTIONAL)
 - A.5. IF SEDIMENT IS AT, OR ABOVE, 3" (80 mm) PROCEED TO STEP 2. IF NOT, PROCEED TO STEP 3.
 - B. ALL ISOLATOR PLUS ROWS
 - B.1. REMOVE COVER FROM STRUCTURE AT UPSTREAM END OF ISOLATOR ROW PLUS
 - B.2. USING A FLASHLIGHT, INSPECT DOWN THE ISOLATOR ROW PLUS THROUGH OUTLET PIPE
 - i) MIRRORS ON POLES OR CAMERAS MAY BE USED TO AVOID A CONFINED SPACE ENTRY
 - ii) FOLLOW OSHA REGULATIONS FOR CONFINED SPACE ENTRY IF ENTERING MANHOLE
 - B.3. IF SEDIMENT IS AT, OR ABOVE, 3" (80 mm) PROCEED TO STEP 2. IF NOT, PROCEED TO STEP 3.
- STEP 2) CLEAN OUT ISOLATOR ROW PLUS USING THE JETVAC PROCESS
- A. A FIXED CULVERT CLEANING NOZZLE WITH REAR FACING SPREAD OF 45" (1.1 m) OR MORE IS PREFERRED
 - B. APPLY MULTIPLE PASSES OF JETVAC UNTIL BACKFLUSH WATER IS CLEAN
 - C. VACUUM STRUCTURE SUMP AS REQUIRED
- STEP 3) REPLACE ALL COVERS, GRATES, FILTERS, AND LIDS; RECORD OBSERVATIONS AND ACTIONS.
- STEP 4) INSPECT AND CLEAN BASINS AND MANHOLES UPSTREAM OF THE STORMTECH SYSTEM.

NOTES

1. INSPECT EVERY 6 MONTHS DURING THE FIRST YEAR OF OPERATION. ADJUST THE INSPECTION INTERVAL BASED ON PREVIOUS OBSERVATIONS OF SEDIMENT ACCUMULATION AND HIGH WATER ELEVATIONS.
2. CONDUCT JETTING AND VACTORING ANNUALLY OR WHEN INSPECTION SHOWS THAT MAINTENANCE IS NECESSARY.

OLD 215

MORENO VALLEY, CA

DRAWN: CS

CHECKED: N/A

DATE:

PROJECT #:

DESCRIPTION

CHK

DATE

DRW

CHK

DATE

DESCRIPTION

CHK

DATE

DESCRIPTION

CHK

DATE

4640 TRUEMAN BLVD
HILLIARD, OH 43026
1-800-733-7473



StormTech®
Chamber System

888-892-2694 | WWW.STORMTECH.COM

THIS DRAWING HAS BEEN PREPARED BASED ON INFORMATION PROVIDED TO ADS UNDER THE DIRECTION OF THE SITE DESIGN ENGINEER OR OTHER PROJECT REPRESENTATIVE. THE SITE DESIGN ENGINEER SHALL REVIEW THIS DRAWING PRIOR TO CONSTRUCTION. IT IS THE ULTIMATE RESPONSIBILITY OF THE SITE DESIGN ENGINEER TO ENSURE THAT THE PRODUCT(S) DEPICTED AND ALL ASSOCIATED DETAILS MEET ALL APPLICABLE LAWS, REGULATIONS, AND PROJECT REQUIREMENTS.

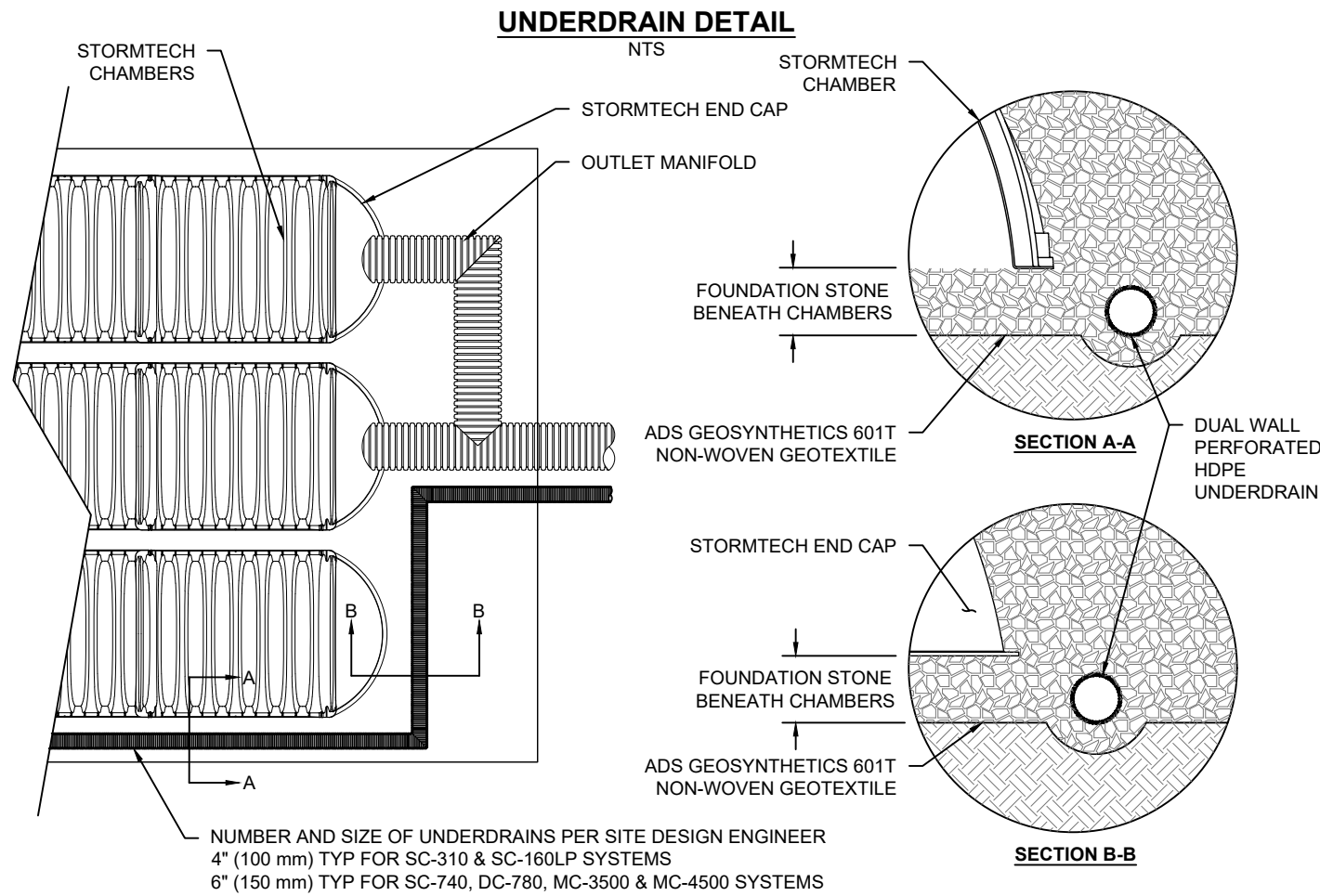

MC-3500 TECHNICAL SPECIFICATION

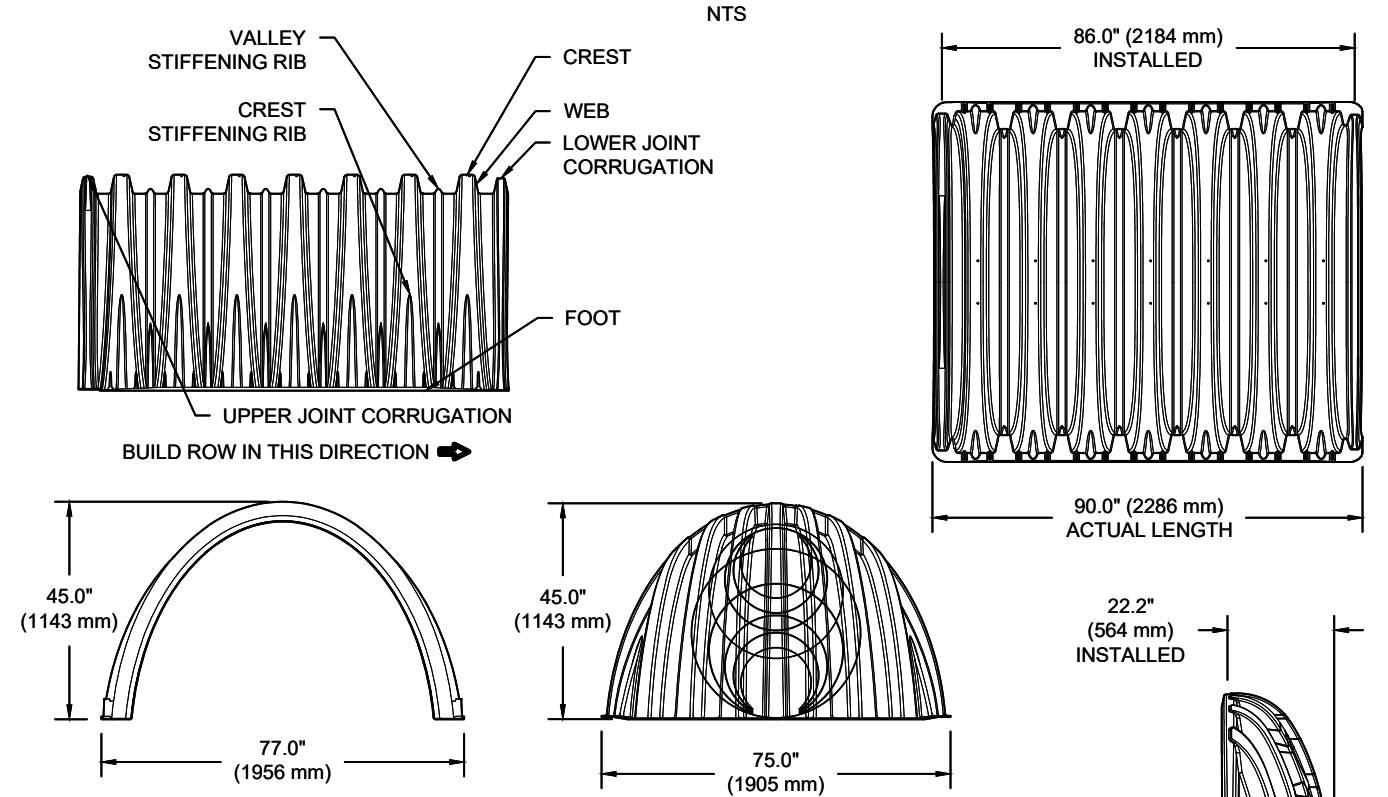

NOMINAL CHAMBER SPECIFICATIONS

SIZE (W X H X INSTALLED LENGTH)		
77.0" X 45.0" X 86.0"	(1956 mm X 1143 mm X 2184 mm)	
CHAMBER STORAGE	109.9 CUBIC FEET	(3.11 m³)
MINIMUM INSTALLED STORAGE*	175.0 CUBIC FEET	(4.96 m³)
WEIGHT	134 lbs.	(60.8 kg)

NOMINAL END CAP SPECIFICATIONS

SIZE (W X H X INSTALLED LENGTH)		
75.0" X 45.0" X 22.2"	(1905 mm X 1143 mm X 564 mm)	
END CAP STORAGE	14.9 CUBIC FEET	(0.42 m³)
MINIMUM INSTALLED STORAGE*	45.1 CUBIC FEET	(1.28 m³)
WEIGHT	49 lbs.	(22.2 kg)

*ASSUMES 12" (305 mm) STONE ABOVE, 9" (229 mm) STONE FOUNDATION, 6" SPACING BETWEEN CHAMBERS, 6" (152 mm) STONE PERIMETER IN FRONT OF END CAPS AND 40% STONE POROSITY

STUBS AT BOTTOM OF END CAP FOR PART NUMBERS ENDING WITH "B"
 STUBS AT TOP OF END CAP FOR PART NUMBERS ENDING WITH "T"
 END CAPS WITH A WELDED CROWN PLATE END WITH "C"
 END CAPS WITH A PREFABRICATED WELDED STUB END WITH "W"

PART #	STUB	B	C
MC3500IEPP06T	6" (150 mm)	33.21" (844 mm)	---
MC3500IEPP06B		---	0.66" (17 mm)
MC3500IEPP08T	8" (200 mm)	31.16" (791 mm)	---
MC3500IEPP08B		---	0.81" (21 mm)
MC3500IEPP10T	10" (250 mm)	29.04" (738 mm)	---
MC3500IEPP10B		---	0.93" (24 mm)
MC3500IEPP12T	12" (300 mm)	26.36" (670 mm)	---
MC3500IEPP12B		---	1.35" (34 mm)
MC3500IEPP15T	15" (375 mm)	23.39" (594 mm)	---
MC3500IEPP15B		---	1.50" (38 mm)
MC3500IEPP18TC	18" (450 mm)	20.03" (509 mm)	---
MC3500IEPP18TW			---
MC3500IEPP18BC			1.77" (45 mm)
MC3500IEPP18BW			---
MC3500IEPP24TC	24" (600 mm)	14.48" (368 mm)	---
MC3500IEPP24TW			---
MC3500IEPP24BC			2.06" (52 mm)
MC3500IEPP24BW			---
MC3500IEPP30BC	30" (750 mm)	---	2.75" (70 mm)

NOTE: ALL DIMENSIONS ARE NOMINAL

MC-SERIES END CAP INSERTION DETAIL

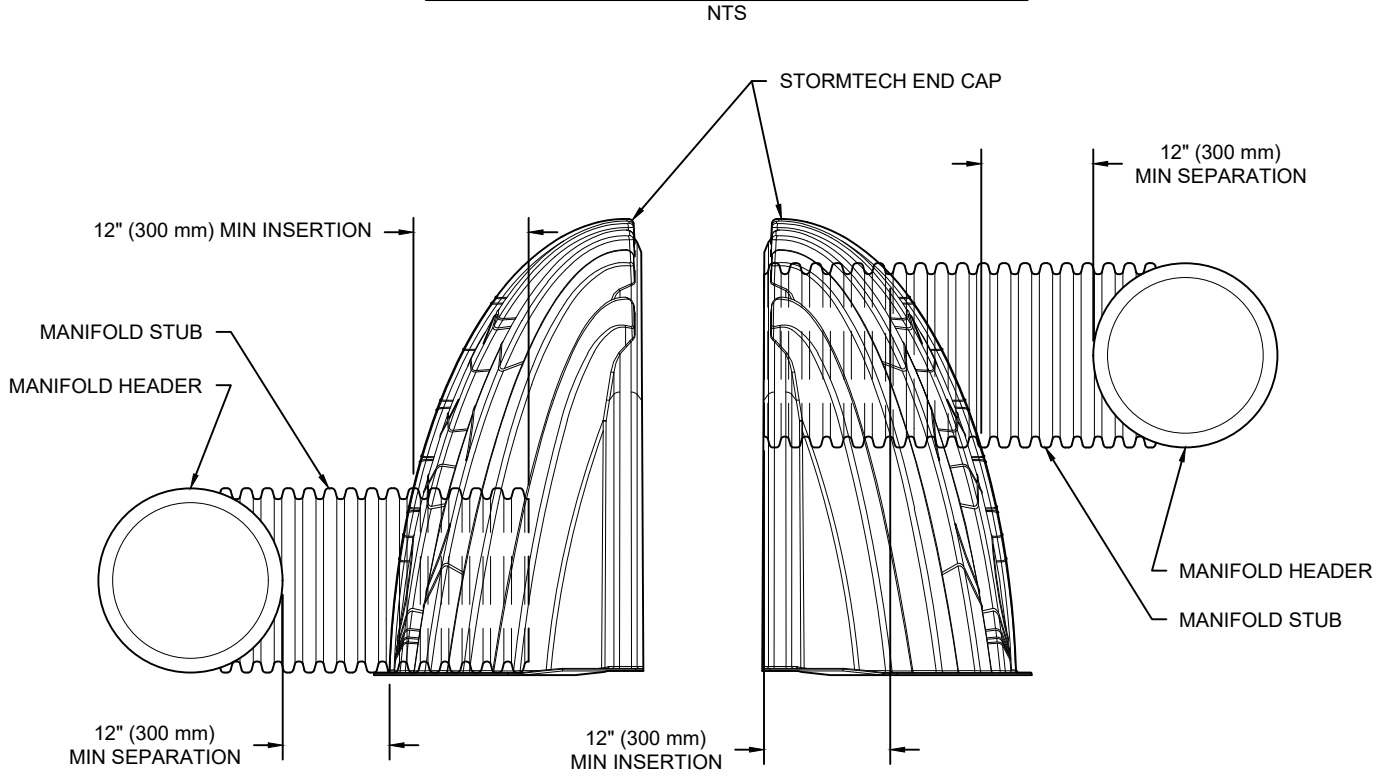

NOTE: MANIFOLD STUB MUST BE LAID HORIZONTAL FOR A PROPER FIT IN END CAP OPENING.

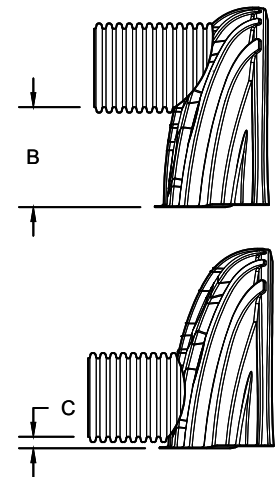

CUSTOM PRECORED INVERTS ARE AVAILABLE UPON REQUEST. INVENTORIED MANIFOLDS INCLUDE 12-24" (300-600 mm) SIZE ON SIZE AND 15-48" (375-1200 mm) ECCENTRIC MANIFOLDS. CUSTOM INVERT LOCATIONS ON THE MC-3500 END CAP CUT IN THE FIELD ARE NOT RECOMMENDED FOR PIPE SIZES GREATER THAN 10" (250 mm). THE INVERT LOCATION IN COLUMN 'B' ARE THE HIGHEST POSSIBLE FOR THE PIPE SIZE.

OLD 215
 MORENO VALLEY, CA

DATE: _____ PROJECT #: _____
 DRAWN: CS CHECKED: N/A

DESCRIPTION

DATE

DRW

CHK

StormTech®
 Chamber System

888-892-2694 | WWW.STORMTECH.COM

4640 TRUEMAN BLVD
 HILLIARD, OH 43026
 1-800-733-7473

ADS

THIS DRAWING HAS BEEN PREPARED BASED ON INFORMATION PROVIDED TO ADS UNDER THE DIRECTION OF THE SITE DESIGN ENGINEER OR OTHER PROJECT REPRESENTATIVE. THE SITE DESIGN ENGINEER SHALL REVIEW THIS DRAWING PRIOR TO CONSTRUCTION. IT IS THE ULTIMATE RESPONSIBILITY OF THE SITE DESIGN ENGINEER TO ENSURE THAT THE PRODUCT(S) DEPICTED AND ALL ASSOCIATED DETAILS MEET ALL APPLICABLE LAWS, REGULATIONS, AND PROJECT REQUIREMENTS.

SHEET
 5 OF 5

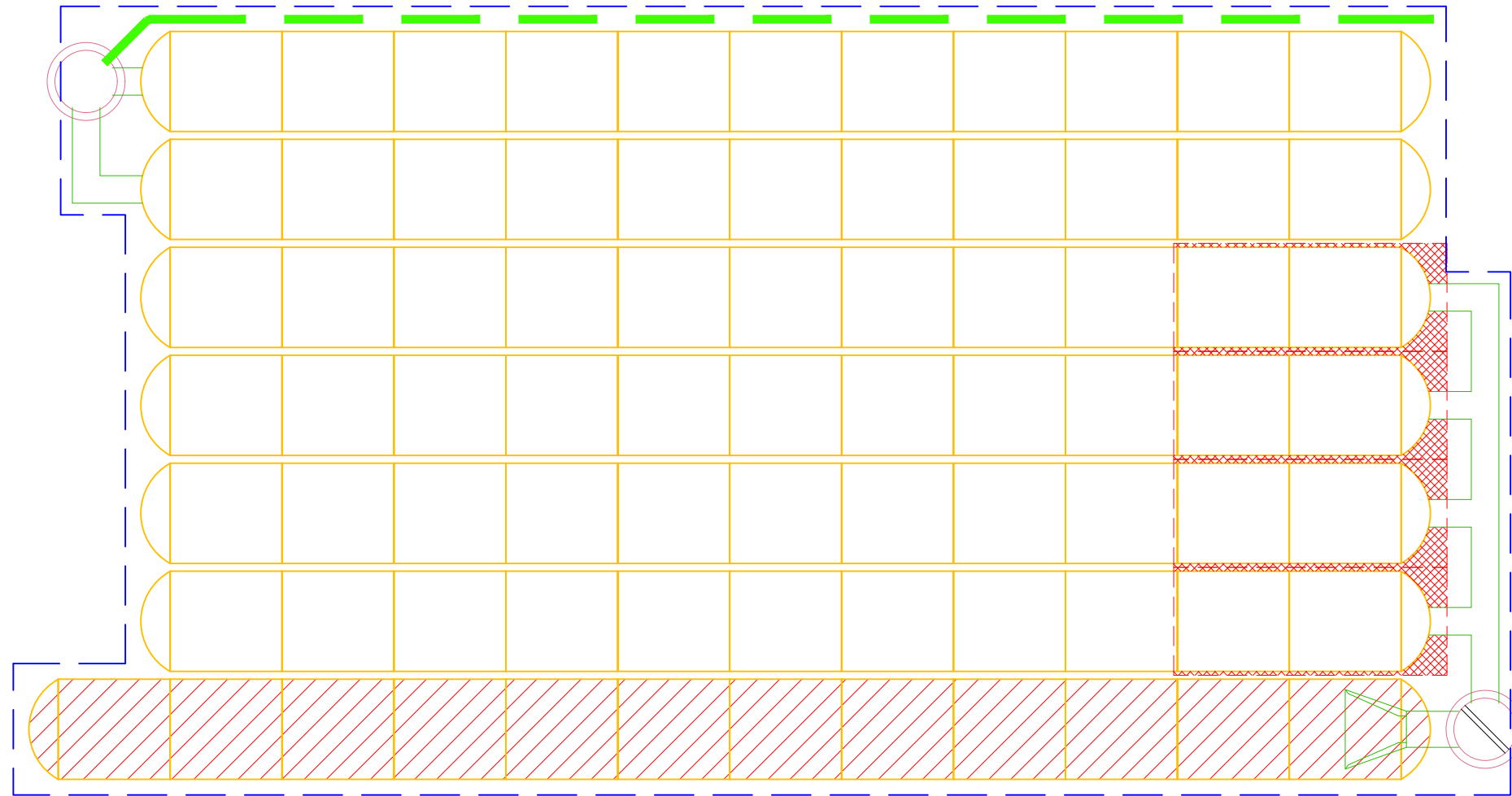

SITE SPECIFIC DATA			
PROJECT NAME			
PROJECT LOCATION			
STRUCTURE ID			
TREATMENT REQUIRED			
VOLUME BASED (CF)		FLOW BASED (CFS)	
TREATMENT HGL AVAILABLE (FT)			
PEAK BYPASS REQUIRED (CFS) - IF APPLICABLE			
PIPE DATA	I.E.	MATERIAL	DIAMETER
INLET PIPE 1			
INLET PIPE 2			
OUTLET PIPE			
	PRETREATMENT	BIOFILTRATION	DISCHARGE
RIM ELEVATION			
SURFACE LOAD	PARKWAY	OPEN PLANTER	PARKWAY
FRAME & COVER	ø30"	N/A	ø24"
WETLANDMEDIA VOLUME (CY)			4.84
WETLANDMEDIA DELIVERY METHOD			TBD
ORIFICE SIZE (DIA. INCHES)			ø2.16"
MAXIMUM PICK WEIGHT (LBS)			TBD
NOTES:			

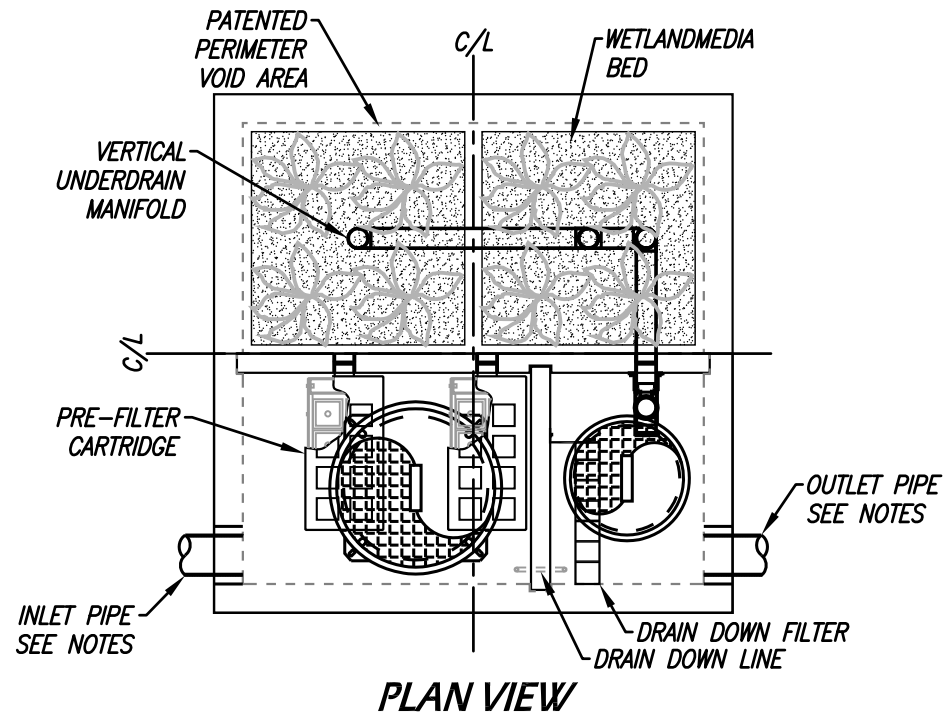

PLAN VIEW

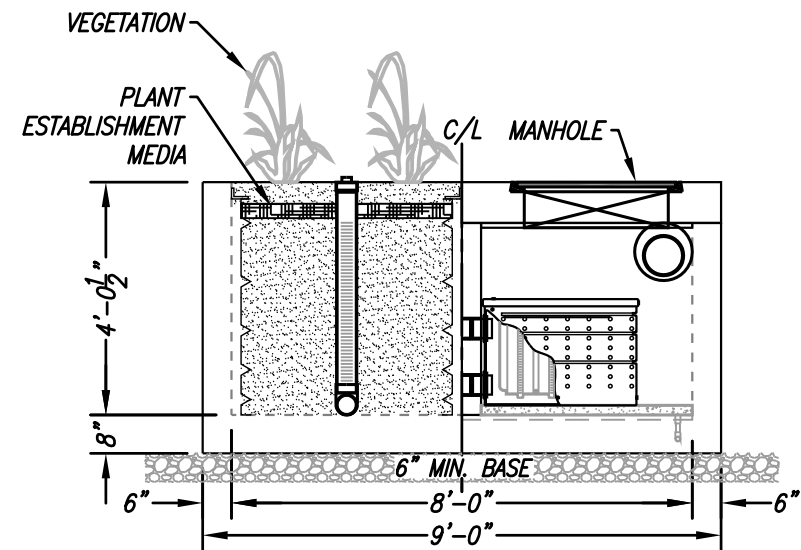

LEFT END VIEW
BIOFILTRATION/PRETREATMENT

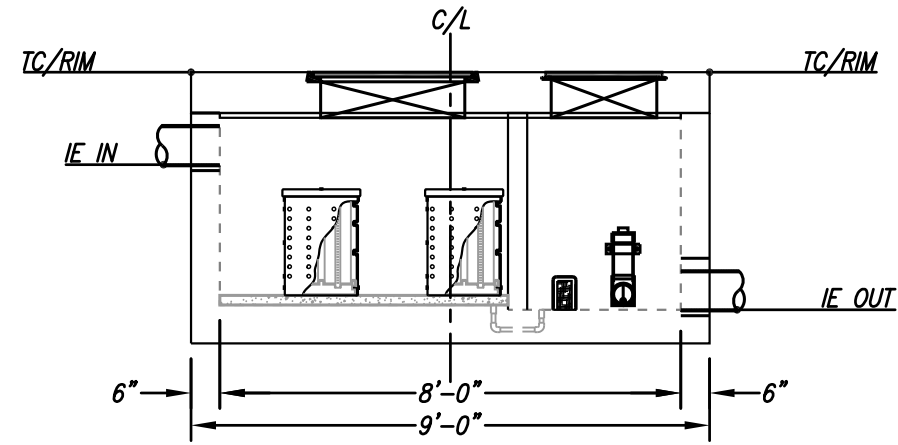

ELEVATION VIEW

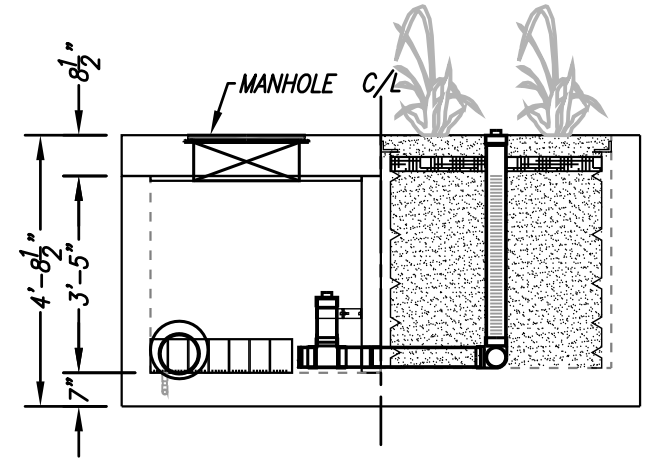

RIGHT END VIEW
DISCHARGE/BIOFILTRATION

INSTALLATION NOTES

1. CONTRACTOR TO PROVIDE ALL LABOR, EQUIPMENT, MATERIALS AND INCIDENTALS REQUIRED TO OFFLOAD AND INSTALL THE SYSTEM AND APPURTENANCES IN ACCORDANCE WITH THIS DRAWING AND THE MANUFACTURERS SPECIFICATIONS, UNLESS OTHERWISE STATED IN MANUFACTURERS CONTRACT.
2. UNIT MUST BE INSTALLED ON LEVEL BASE. MANUFACTURER RECOMMENDS A MINIMUM 6" LEVEL ROCK BASE UNLESS SPECIFIED BY THE PROJECT ENGINEER. CONTRACTOR IS RESPONSIBLE TO VERIFY PROJECT ENGINEERS RECOMMENDED BASE SPECIFICATIONS.
3. ALL PIPES MUST BE FLUSH WITH INSIDE SURFACE OF CONCRETE. (PIPES CANNOT INTRUDE BEYOND FLUSH). INVERT OF OUTFLOW PIPE MUST BE FLUSH WITH DISCHARGE CHAMBER FLOOR. ALL GAPS AROUND PIPES SHALL BE SEALED WATER TIGHT WITH A NON-SHRINK GROUT PER MANUFACTURERS STANDARD CONNECTION DETAIL AND SHALL MEET OR EXCEED REGIONAL PIPE CONNECTION STANDARDS.
4. CONTRACTOR TO SUPPLY AND INSTALL ALL EXTERNAL CONNECTING PIPES.
5. CONTRACTOR RESPONSIBLE FOR INSTALLATION OF ALL RISERS, MANHOLES, AND HATCHES. CONTRACTOR TO GROUT ALL MANHOLES AND HATCHES TO MATCH FINISHED SURFACE UNLESS SPECIFIED OTHERWISE.
6. DRIP OR SPRAY IRRIGATION REQUIRED ON ALL UNITS WITH VEGETATION.

GENERAL NOTES

1. MANUFACTURER TO PROVIDE ALL MATERIALS UNLESS OTHERWISE NOTED.
2. ALL DIMENSIONS, ELEVATIONS, SPECIFICATIONS AND CAPACITIES ARE SUBJECT TO CHANGE. FOR PROJECT SPECIFIC DRAWINGS DETAILING EXACT DIMENSIONS, WEIGHTS AND ACCESSORIES PLEASE CONTACT MANUFACTURER.

TREATMENT FLOW (CFS)	0.230
OPERATING HEAD (FT)	3.4
PRETREATMENT LOADING RATE (GPM/SF)	TBD
WETLAND MEDIA LOADING RATE (GPM/SF)	1.0

THE PRODUCT DESCRIBED MAY BE PROTECTED BY ONE OR MORE OF THE FOLLOWING US PATENTS: 7,425,262; 7,470,362; 7,674,378; 8,303,816; RELATED FOREIGN PATENTS OR OTHER PATENTS PENDING

PROPRIETARY AND CONFIDENTIAL:
THE INFORMATION CONTAINED IN THIS DRAWING IS THE SOLE PROPERTY OF MODULAR WETLANDS SYSTEMS. ANY REPRODUCTION IN PART OR AS A WHOLE WITHOUT THE WRITTEN PERMISSION OF MODULAR WETLANDS SYSTEMS IS PROHIBITED.



MWS-L-8-8-V
STORMWATER BIOFILTRATION SYSTEM
STANDARD DETAIL

Appendix 7: Hydromodification

Supporting Detail Relating to Hydrologic Conditions of Concern

Underground detention chambers will be utilized to contain runoff and slowly release runoff via pump & Modular Wetlands System into Edgemont Channel. Proposed conditions will mimic pre-existing conditions by utilization of the detention chambers, pump, and Modular Wetland System.

After the inclusion of the detention chambers, pump, and MWS the post-development conditions are less than pre-development conditions.

	2 year – 24 hour		
	Pre-condition	Post-condition	Post-condition with MWS
Flow Rate (cfs)	0.252	1.384	0.23

Unit Hydrograph Analysis

Copyright (c) CIVILCADD/CIVILDESIGN, 1989 - 2004, Version 7.0
Study date 12/08/21 File: 2242.out

+++++

Riverside County Synthetic Unit Hydrology Method
RCFC & WCD Manual date - April 1978

Program License Serial Number 4042

English (in-lb) Input Units Used
English Rainfall Data (Inches) Input Values Used

English Units used in output format

1494-0006 OLD 215 FRONTAGE ROAD
EXISTING CONDITION
2-YEAR, 24-HOUR STORM EVENT

Drainage Area = 7.07(Ac.) = 0.011 Sq. Mi.
Drainage Area for Depth-Area Areal Adjustment = 7.07(Ac.) = 0.011
Sq. Mi.

USER Entry of lag time in hours
Lag time = 0.189 Hr.
Lag time = 11.33 Min.
25% of lag time = 2.83 Min.
40% of lag time = 4.53 Min.
Unit time = 5.00 Min.
Duration of storm = 24 Hour(s)
User Entered Base Flow = 0.00 (CFS)

2 YEAR Area rainfall data:

Area(Ac.) [1]	Rainfall(In) [2]	Weighting[1*2]
7.07	1.85	13.08

100 YEAR Area rainfall data:

Area(Ac.) [1]	Rainfall(In) [2]	Weighting[1*2]
7.07	4.52	31.96

STORM EVENT (YEAR) = 2.00
Area Averaged 2-Year Rainfall = 1.850 (In)
Area Averaged 100-Year Rainfall = 4.520 (In)

Point rain (area averaged) = 1.850 (In)
Areal adjustment factor = 100.00 %

Adjusted average point rain = 1.850 (In)

Sub-Area Data:

Area (Ac.) Runoff Index Impervious %
 7.070 91.00 0.000
 Total Area Entered = 7.07 (Ac.)

RI	RI	Infil. Rate	Impervious	Adj. Infil. Rate	Area%	F
AMC2	AMC-1	(In/Hr)	(Dec.%)	(In/Hr)	(Dec.)	(In/Hr)
91.0	79.8	0.246	0.000	0.246	1.000	0.246
						Sum (F) = 0.246

Area averaged mean soil loss (F) (In/Hr) = 0.246
 Minimum soil loss rate ((In/Hr)) = 0.123
 (for 24 hour storm duration)
 Soil low loss rate (decimal) = 0.900

 U n i t H y d r o g r a p h
 VALLEY S-Curve

Unit Hydrograph Data

Unit time period (hrs)	Time % of lag	Distribution Graph %	Unit Hydrograph (CFS)
1	0.083	44.138	5.059
2	0.167	88.277	21.222
3	0.250	132.415	28.410
4	0.333	176.554	15.425
5	0.417	220.692	7.544
6	0.500	264.831	5.082
7	0.583	308.969	3.785
8	0.667	353.107	2.833
9	0.750	397.246	2.247
10	0.833	441.384	1.709
11	0.917	485.523	1.385
12	1.000	529.661	1.246
13	1.083	573.799	0.964
14	1.167	617.938	0.799
15	1.250	662.076	0.642
16	1.333	706.215	0.488
17	1.417	750.353	0.441
18	1.500	794.492	0.441
19	1.583	838.630	0.276
		Sum = 100.000	Sum= 7.125

Unit Time (Hr.)	Pattern Percent	Storm Rain (In/Hr)	Loss rate (In./Hr)		Effective (In/Hr)
			Max	Low	
1	0.08	0.07	0.437	0.013	0.00
2	0.17	0.07	0.435	0.013	0.00
3	0.25	0.07	0.433	0.013	0.00
4	0.33	0.10	0.432	0.020	0.00
5	0.42	0.10	0.430	0.020	0.00
6	0.50	0.10	0.428	0.020	0.00
7	0.58	0.10	0.427	0.020	0.00
8	0.67	0.10	0.425	0.020	0.00
9	0.75	0.10	0.423	0.020	0.00

10	0.83	0.13	0.030	0.422	0.027	0.00
11	0.92	0.13	0.030	0.420	0.027	0.00
12	1.00	0.13	0.030	0.418	0.027	0.00
13	1.08	0.10	0.022	0.417	0.020	0.00
14	1.17	0.10	0.022	0.415	0.020	0.00
15	1.25	0.10	0.022	0.413	0.020	0.00
16	1.33	0.10	0.022	0.412	0.020	0.00
17	1.42	0.10	0.022	0.410	0.020	0.00
18	1.50	0.10	0.022	0.408	0.020	0.00
19	1.58	0.10	0.022	0.407	0.020	0.00
20	1.67	0.10	0.022	0.405	0.020	0.00
21	1.75	0.10	0.022	0.404	0.020	0.00
22	1.83	0.13	0.030	0.402	0.027	0.00
23	1.92	0.13	0.030	0.400	0.027	0.00
24	2.00	0.13	0.030	0.399	0.027	0.00
25	2.08	0.13	0.030	0.397	0.027	0.00
26	2.17	0.13	0.030	0.395	0.027	0.00
27	2.25	0.13	0.030	0.394	0.027	0.00
28	2.33	0.13	0.030	0.392	0.027	0.00
29	2.42	0.13	0.030	0.391	0.027	0.00
30	2.50	0.13	0.030	0.389	0.027	0.00
31	2.58	0.17	0.037	0.387	0.033	0.00
32	2.67	0.17	0.037	0.386	0.033	0.00
33	2.75	0.17	0.037	0.384	0.033	0.00
34	2.83	0.17	0.037	0.383	0.033	0.00
35	2.92	0.17	0.037	0.381	0.033	0.00
36	3.00	0.17	0.037	0.380	0.033	0.00
37	3.08	0.17	0.037	0.378	0.033	0.00
38	3.17	0.17	0.037	0.376	0.033	0.00
39	3.25	0.17	0.037	0.375	0.033	0.00
40	3.33	0.17	0.037	0.373	0.033	0.00
41	3.42	0.17	0.037	0.372	0.033	0.00
42	3.50	0.17	0.037	0.370	0.033	0.00
43	3.58	0.17	0.037	0.369	0.033	0.00
44	3.67	0.17	0.037	0.367	0.033	0.00
45	3.75	0.17	0.037	0.366	0.033	0.00
46	3.83	0.20	0.044	0.364	0.040	0.00
47	3.92	0.20	0.044	0.362	0.040	0.00
48	4.00	0.20	0.044	0.361	0.040	0.00
49	4.08	0.20	0.044	0.359	0.040	0.00
50	4.17	0.20	0.044	0.358	0.040	0.00
51	4.25	0.20	0.044	0.356	0.040	0.00
52	4.33	0.23	0.052	0.355	0.047	0.01
53	4.42	0.23	0.052	0.353	0.047	0.01
54	4.50	0.23	0.052	0.352	0.047	0.01
55	4.58	0.23	0.052	0.350	0.047	0.01
56	4.67	0.23	0.052	0.349	0.047	0.01
57	4.75	0.23	0.052	0.347	0.047	0.01
58	4.83	0.27	0.059	0.346	0.053	0.01
59	4.92	0.27	0.059	0.344	0.053	0.01
60	5.00	0.27	0.059	0.343	0.053	0.01
61	5.08	0.20	0.044	0.341	0.040	0.00
62	5.17	0.20	0.044	0.340	0.040	0.00
63	5.25	0.20	0.044	0.338	0.040	0.00
64	5.33	0.23	0.052	0.337	0.047	0.01
65	5.42	0.23	0.052	0.335	0.047	0.01
66	5.50	0.23	0.052	0.334	0.047	0.01
67	5.58	0.27	0.059	0.332	0.053	0.01
68	5.67	0.27	0.059	0.331	0.053	0.01
69	5.75	0.27	0.059	0.330	0.053	0.01

70	5.83	0.27	0.059	0.328	0.053	0.01
71	5.92	0.27	0.059	0.327	0.053	0.01
72	6.00	0.27	0.059	0.325	0.053	0.01
73	6.08	0.30	0.067	0.324	0.060	0.01
74	6.17	0.30	0.067	0.322	0.060	0.01
75	6.25	0.30	0.067	0.321	0.060	0.01
76	6.33	0.30	0.067	0.319	0.060	0.01
77	6.42	0.30	0.067	0.318	0.060	0.01
78	6.50	0.30	0.067	0.317	0.060	0.01
79	6.58	0.33	0.074	0.315	0.067	0.01
80	6.67	0.33	0.074	0.314	0.067	0.01
81	6.75	0.33	0.074	0.312	0.067	0.01
82	6.83	0.33	0.074	0.311	0.067	0.01
83	6.92	0.33	0.074	0.310	0.067	0.01
84	7.00	0.33	0.074	0.308	0.067	0.01
85	7.08	0.33	0.074	0.307	0.067	0.01
86	7.17	0.33	0.074	0.305	0.067	0.01
87	7.25	0.33	0.074	0.304	0.067	0.01
88	7.33	0.37	0.081	0.303	0.073	0.01
89	7.42	0.37	0.081	0.301	0.073	0.01
90	7.50	0.37	0.081	0.300	0.073	0.01
91	7.58	0.40	0.089	0.298	0.080	0.01
92	7.67	0.40	0.089	0.297	0.080	0.01
93	7.75	0.40	0.089	0.296	0.080	0.01
94	7.83	0.43	0.096	0.294	0.087	0.01
95	7.92	0.43	0.096	0.293	0.087	0.01
96	8.00	0.43	0.096	0.292	0.087	0.01
97	8.08	0.50	0.111	0.290	0.100	0.01
98	8.17	0.50	0.111	0.289	0.100	0.01
99	8.25	0.50	0.111	0.288	0.100	0.01
100	8.33	0.50	0.111	0.286	0.100	0.01
101	8.42	0.50	0.111	0.285	0.100	0.01
102	8.50	0.50	0.111	0.283	0.100	0.01
103	8.58	0.53	0.118	0.282	0.107	0.01
104	8.67	0.53	0.118	0.281	0.107	0.01
105	8.75	0.53	0.118	0.280	0.107	0.01
106	8.83	0.57	0.126	0.278	0.113	0.01
107	8.92	0.57	0.126	0.277	0.113	0.01
108	9.00	0.57	0.126	0.276	0.113	0.01
109	9.08	0.63	0.141	0.274	0.127	0.01
110	9.17	0.63	0.141	0.273	0.127	0.01
111	9.25	0.63	0.141	0.272	0.127	0.01
112	9.33	0.67	0.148	0.270	0.133	0.01
113	9.42	0.67	0.148	0.269	0.133	0.01
114	9.50	0.67	0.148	0.268	0.133	0.01
115	9.58	0.70	0.155	0.267	0.140	0.02
116	9.67	0.70	0.155	0.265	0.140	0.02
117	9.75	0.70	0.155	0.264	0.140	0.02
118	9.83	0.73	0.163	0.263	0.147	0.02
119	9.92	0.73	0.163	0.261	0.147	0.02
120	10.00	0.73	0.163	0.260	0.147	0.02
121	10.08	0.50	0.111	0.259	0.100	0.01
122	10.17	0.50	0.111	0.258	0.100	0.01
123	10.25	0.50	0.111	0.256	0.100	0.01
124	10.33	0.50	0.111	0.255	0.100	0.01
125	10.42	0.50	0.111	0.254	0.100	0.01
126	10.50	0.50	0.111	0.253	0.100	0.01
127	10.58	0.67	0.148	0.251	0.133	0.01
128	10.67	0.67	0.148	0.250	0.133	0.01
129	10.75	0.67	0.148	0.249	0.133	0.01

130	10.83	0.67	0.148	0.248	0.133	0.01
131	10.92	0.67	0.148	0.247	0.133	0.01
132	11.00	0.67	0.148	0.245	0.133	0.01
133	11.08	0.63	0.141	0.244	0.127	0.01
134	11.17	0.63	0.141	0.243	0.127	0.01
135	11.25	0.63	0.141	0.242	0.127	0.01
136	11.33	0.63	0.141	0.241	0.127	0.01
137	11.42	0.63	0.141	0.239	0.127	0.01
138	11.50	0.63	0.141	0.238	0.127	0.01
139	11.58	0.57	0.126	0.237	0.113	0.01
140	11.67	0.57	0.126	0.236	0.113	0.01
141	11.75	0.57	0.126	0.235	0.113	0.01
142	11.83	0.60	0.133	0.233	0.120	0.01
143	11.92	0.60	0.133	0.232	0.120	0.01
144	12.00	0.60	0.133	0.231	0.120	0.01
145	12.08	0.83	0.185	0.230	0.166	0.02
146	12.17	0.83	0.185	0.229	0.166	0.02
147	12.25	0.83	0.185	0.228	0.166	0.02
148	12.33	0.87	0.192	0.227	0.173	0.02
149	12.42	0.87	0.192	0.225	0.173	0.02
150	12.50	0.87	0.192	0.224	0.173	0.02
151	12.58	0.93	0.207	0.223	0.186	0.02
152	12.67	0.93	0.207	0.222	0.186	0.02
153	12.75	0.93	0.207	0.221	0.186	0.02
154	12.83	0.97	0.215	0.220	0.193	0.02
155	12.92	0.97	0.215	0.219	0.193	0.02
156	13.00	0.97	0.215	0.218	0.193	0.02
157	13.08	1.13	0.252	0.216	---	0.04
158	13.17	1.13	0.252	0.215	---	0.04
159	13.25	1.13	0.252	0.214	---	0.04
160	13.33	1.13	0.252	0.213	---	0.04
161	13.42	1.13	0.252	0.212	---	0.04
162	13.50	1.13	0.252	0.211	---	0.04
163	13.58	0.77	0.170	0.210	0.153	0.02
164	13.67	0.77	0.170	0.209	0.153	0.02
165	13.75	0.77	0.170	0.208	0.153	0.02
166	13.83	0.77	0.170	0.207	0.153	0.02
167	13.92	0.77	0.170	0.206	0.153	0.02
168	14.00	0.77	0.170	0.205	0.153	0.02
169	14.08	0.90	0.200	0.204	0.180	0.02
170	14.17	0.90	0.200	0.203	0.180	0.02
171	14.25	0.90	0.200	0.202	0.180	0.02
172	14.33	0.87	0.192	0.200	0.173	0.02
173	14.42	0.87	0.192	0.199	0.173	0.02
174	14.50	0.87	0.192	0.198	0.173	0.02
175	14.58	0.87	0.192	0.197	0.173	0.02
176	14.67	0.87	0.192	0.196	0.173	0.02
177	14.75	0.87	0.192	0.195	0.173	0.02
178	14.83	0.83	0.185	0.194	0.166	0.02
179	14.92	0.83	0.185	0.193	0.166	0.02
180	15.00	0.83	0.185	0.192	0.166	0.02
181	15.08	0.80	0.178	0.191	0.160	0.02
182	15.17	0.80	0.178	0.190	0.160	0.02
183	15.25	0.80	0.178	0.189	0.160	0.02
184	15.33	0.77	0.170	0.188	0.153	0.02
185	15.42	0.77	0.170	0.188	0.153	0.02
186	15.50	0.77	0.170	0.187	0.153	0.02
187	15.58	0.63	0.141	0.186	0.127	0.01
188	15.67	0.63	0.141	0.185	0.127	0.01
189	15.75	0.63	0.141	0.184	0.127	0.01

190	15.83	0.63	0.141	0.183	0.127	0.01
191	15.92	0.63	0.141	0.182	0.127	0.01
192	16.00	0.63	0.141	0.181	0.127	0.01
193	16.08	0.13	0.030	0.180	0.027	0.00
194	16.17	0.13	0.030	0.179	0.027	0.00
195	16.25	0.13	0.030	0.178	0.027	0.00
196	16.33	0.13	0.030	0.177	0.027	0.00
197	16.42	0.13	0.030	0.176	0.027	0.00
198	16.50	0.13	0.030	0.175	0.027	0.00
199	16.58	0.10	0.022	0.175	0.020	0.00
200	16.67	0.10	0.022	0.174	0.020	0.00
201	16.75	0.10	0.022	0.173	0.020	0.00
202	16.83	0.10	0.022	0.172	0.020	0.00
203	16.92	0.10	0.022	0.171	0.020	0.00
204	17.00	0.10	0.022	0.170	0.020	0.00
205	17.08	0.17	0.037	0.169	0.033	0.00
206	17.17	0.17	0.037	0.168	0.033	0.00
207	17.25	0.17	0.037	0.168	0.033	0.00
208	17.33	0.17	0.037	0.167	0.033	0.00
209	17.42	0.17	0.037	0.166	0.033	0.00
210	17.50	0.17	0.037	0.165	0.033	0.00
211	17.58	0.17	0.037	0.164	0.033	0.00
212	17.67	0.17	0.037	0.163	0.033	0.00
213	17.75	0.17	0.037	0.163	0.033	0.00
214	17.83	0.13	0.030	0.162	0.027	0.00
215	17.92	0.13	0.030	0.161	0.027	0.00
216	18.00	0.13	0.030	0.160	0.027	0.00
217	18.08	0.13	0.030	0.159	0.027	0.00
218	18.17	0.13	0.030	0.159	0.027	0.00
219	18.25	0.13	0.030	0.158	0.027	0.00
220	18.33	0.13	0.030	0.157	0.027	0.00
221	18.42	0.13	0.030	0.156	0.027	0.00
222	18.50	0.13	0.030	0.156	0.027	0.00
223	18.58	0.10	0.022	0.155	0.020	0.00
224	18.67	0.10	0.022	0.154	0.020	0.00
225	18.75	0.10	0.022	0.153	0.020	0.00
226	18.83	0.07	0.015	0.153	0.013	0.00
227	18.92	0.07	0.015	0.152	0.013	0.00
228	19.00	0.07	0.015	0.151	0.013	0.00
229	19.08	0.10	0.022	0.150	0.020	0.00
230	19.17	0.10	0.022	0.150	0.020	0.00
231	19.25	0.10	0.022	0.149	0.020	0.00
232	19.33	0.13	0.030	0.148	0.027	0.00
233	19.42	0.13	0.030	0.148	0.027	0.00
234	19.50	0.13	0.030	0.147	0.027	0.00
235	19.58	0.10	0.022	0.146	0.020	0.00
236	19.67	0.10	0.022	0.146	0.020	0.00
237	19.75	0.10	0.022	0.145	0.020	0.00
238	19.83	0.07	0.015	0.144	0.013	0.00
239	19.92	0.07	0.015	0.144	0.013	0.00
240	20.00	0.07	0.015	0.143	0.013	0.00
241	20.08	0.10	0.022	0.142	0.020	0.00
242	20.17	0.10	0.022	0.142	0.020	0.00
243	20.25	0.10	0.022	0.141	0.020	0.00
244	20.33	0.10	0.022	0.141	0.020	0.00
245	20.42	0.10	0.022	0.140	0.020	0.00
246	20.50	0.10	0.022	0.139	0.020	0.00
247	20.58	0.10	0.022	0.139	0.020	0.00
248	20.67	0.10	0.022	0.138	0.020	0.00
249	20.75	0.10	0.022	0.138	0.020	0.00

250	20.83	0.07	0.015	0.137	0.013	0.00
251	20.92	0.07	0.015	0.137	0.013	0.00
252	21.00	0.07	0.015	0.136	0.013	0.00
253	21.08	0.10	0.022	0.135	0.020	0.00
254	21.17	0.10	0.022	0.135	0.020	0.00
255	21.25	0.10	0.022	0.134	0.020	0.00
256	21.33	0.07	0.015	0.134	0.013	0.00
257	21.42	0.07	0.015	0.133	0.013	0.00
258	21.50	0.07	0.015	0.133	0.013	0.00
259	21.58	0.10	0.022	0.132	0.020	0.00
260	21.67	0.10	0.022	0.132	0.020	0.00
261	21.75	0.10	0.022	0.131	0.020	0.00
262	21.83	0.07	0.015	0.131	0.013	0.00
263	21.92	0.07	0.015	0.131	0.013	0.00
264	22.00	0.07	0.015	0.130	0.013	0.00
265	22.08	0.10	0.022	0.130	0.020	0.00
266	22.17	0.10	0.022	0.129	0.020	0.00
267	22.25	0.10	0.022	0.129	0.020	0.00
268	22.33	0.07	0.015	0.128	0.013	0.00
269	22.42	0.07	0.015	0.128	0.013	0.00
270	22.50	0.07	0.015	0.128	0.013	0.00
271	22.58	0.07	0.015	0.127	0.013	0.00
272	22.67	0.07	0.015	0.127	0.013	0.00
273	22.75	0.07	0.015	0.127	0.013	0.00
274	22.83	0.07	0.015	0.126	0.013	0.00
275	22.92	0.07	0.015	0.126	0.013	0.00
276	23.00	0.07	0.015	0.126	0.013	0.00
277	23.08	0.07	0.015	0.125	0.013	0.00
278	23.17	0.07	0.015	0.125	0.013	0.00
279	23.25	0.07	0.015	0.125	0.013	0.00
280	23.33	0.07	0.015	0.125	0.013	0.00
281	23.42	0.07	0.015	0.124	0.013	0.00
282	23.50	0.07	0.015	0.124	0.013	0.00
283	23.58	0.07	0.015	0.124	0.013	0.00
284	23.67	0.07	0.015	0.124	0.013	0.00
285	23.75	0.07	0.015	0.124	0.013	0.00
286	23.83	0.07	0.015	0.123	0.013	0.00
287	23.92	0.07	0.015	0.123	0.013	0.00
288	24.00	0.07	0.015	0.123	0.013	0.00

Sum = 100.0 Sum = 2.3

Flood volume = Effective rainfall 0.19(In)
times area 7.1(Ac.)/[(In)/(Ft.)] = 0.1(Ac.Ft)
Total soil loss = 1.66(In)
Total soil loss = 0.977(Ac.Ft)
Total rainfall = 1.85(In)
Flood volume = 4910.9 Cubic Feet
Total soil loss = 42567.0 Cubic Feet

Peak flow rate of this hydrograph = 0.252(CFS)

+++++
24 - H O U R S T O R M
R u n o f f H y d r o g r a p h

Hydrograph in 5 Minute intervals ((CFS))

Time (h+m)	Volume Ac.Ft	Q(CFS)	0	2.5	5.0	7.5	10.0
0+ 5	0.0000	0.00	Q				

0+10	0.0000	0.00	Q				
0+15	0.0001	0.01	Q				
0+20	0.0001	0.01	Q				
0+25	0.0002	0.01	Q				
0+30	0.0003	0.01	Q				
0+35	0.0003	0.01	Q				
0+40	0.0004	0.01	Q				
0+45	0.0005	0.01	Q				
0+50	0.0006	0.01	Q				
0+55	0.0008	0.02	Q				
1+ 0	0.0009	0.02	Q				
1+ 5	0.0010	0.02	Q				
1+10	0.0011	0.02	Q				
1+15	0.0012	0.02	Q				
1+20	0.0014	0.02	Q				
1+25	0.0015	0.02	Q				
1+30	0.0016	0.02	Q				
1+35	0.0017	0.02	Q				
1+40	0.0018	0.02	Q				
1+45	0.0019	0.02	Q				
1+50	0.0020	0.02	Q				
1+55	0.0021	0.02	Q				
2+ 0	0.0023	0.02	Q				
2+ 5	0.0024	0.02	Q				
2+10	0.0025	0.02	Q				
2+15	0.0027	0.02	Q				
2+20	0.0028	0.02	QV				
2+25	0.0030	0.02	QV				
2+30	0.0031	0.02	QV				
2+35	0.0033	0.02	QV				
2+40	0.0034	0.02	QV				
2+45	0.0036	0.02	QV				
2+50	0.0037	0.02	QV				
2+55	0.0039	0.03	QV				
3+ 0	0.0041	0.03	QV				
3+ 5	0.0043	0.03	QV				
3+10	0.0044	0.03	QV				
3+15	0.0046	0.03	QV				
3+20	0.0048	0.03	QV				
3+25	0.0050	0.03	QV				
3+30	0.0052	0.03	QV				
3+35	0.0053	0.03	QV				
3+40	0.0055	0.03	QV				
3+45	0.0057	0.03	Q V				
3+50	0.0059	0.03	Q V				
3+55	0.0061	0.03	Q V				
4+ 0	0.0063	0.03	Q V				
4+ 5	0.0065	0.03	Q V				
4+10	0.0067	0.03	Q V				
4+15	0.0069	0.03	Q V				
4+20	0.0071	0.03	Q V				
4+25	0.0073	0.03	Q V				
4+30	0.0076	0.03	Q V				
4+35	0.0078	0.03	Q V				
4+40	0.0081	0.04	Q V				
4+45	0.0083	0.04	Q V				
4+50	0.0086	0.04	Q V				
4+55	0.0088	0.04	Q V				
5+ 0	0.0091	0.04	Q V				
5+ 5	0.0094	0.04	Q V				

5+10	0.0096	0.04	Q	V				
5+15	0.0099	0.04	Q	V				
5+20	0.0101	0.03	Q	V				
5+25	0.0103	0.03	Q	V				
5+30	0.0106	0.04	Q	V				
5+35	0.0108	0.04	Q	V				
5+40	0.0111	0.04	Q	V				
5+45	0.0114	0.04	Q	V				
5+50	0.0117	0.04	Q	V				
5+55	0.0119	0.04	Q	V				
6+ 0	0.0122	0.04	Q	V				
6+ 5	0.0125	0.04	Q	V				
6+10	0.0128	0.04	Q	V				
6+15	0.0131	0.04	Q	V				
6+20	0.0134	0.05	Q	V				
6+25	0.0137	0.05	Q	V				
6+30	0.0141	0.05	Q	V				
6+35	0.0144	0.05	Q	V				
6+40	0.0147	0.05	Q	V				
6+45	0.0151	0.05	Q	V				
6+50	0.0154	0.05	Q	V				
6+55	0.0158	0.05	Q	V				
7+ 0	0.0161	0.05	Q	V				
7+ 5	0.0165	0.05	Q	V				
7+10	0.0168	0.05	Q	V				
7+15	0.0172	0.05	Q	V				
7+20	0.0176	0.05	Q	V				
7+25	0.0179	0.05	Q	V				
7+30	0.0183	0.06	Q	V				
7+35	0.0187	0.06	Q	V				
7+40	0.0191	0.06	Q	V				
7+45	0.0195	0.06	Q	V				
7+50	0.0199	0.06	Q	V				
7+55	0.0204	0.06	Q	V				
8+ 0	0.0208	0.06	Q	V				
8+ 5	0.0213	0.07	Q	V				
8+10	0.0217	0.07	Q	V				
8+15	0.0222	0.07	Q	V				
8+20	0.0228	0.07	Q	V				
8+25	0.0233	0.08	Q	V				
8+30	0.0238	0.08	Q	V				
8+35	0.0243	0.08	Q	V				
8+40	0.0249	0.08	Q	V				
8+45	0.0254	0.08	Q	V				
8+50	0.0260	0.08	Q	V				
8+55	0.0266	0.08	Q	V				
9+ 0	0.0272	0.09	Q	V				
9+ 5	0.0278	0.09	Q	V				
9+10	0.0284	0.09	Q	V				
9+15	0.0291	0.09	Q	V				
9+20	0.0297	0.10	Q	V				
9+25	0.0304	0.10	Q	V				
9+30	0.0311	0.10	Q	V				
9+35	0.0318	0.10	Q	V				
9+40	0.0325	0.10	Q	V				
9+45	0.0332	0.11	Q	V				
9+50	0.0340	0.11	Q	V				
9+55	0.0347	0.11	Q	V				
10+ 0	0.0355	0.11	Q	V				
10+ 5	0.0363	0.11	Q	V				

10+10	0.0370	0.10	Q	V				
10+15	0.0376	0.09	Q	V				
10+20	0.0382	0.09	Q	V				
10+25	0.0388	0.09	Q	V				
10+30	0.0394	0.08	Q	V				
10+35	0.0400	0.08	Q	V				
10+40	0.0406	0.09	Q	V				
10+45	0.0413	0.10	Q	V				
10+50	0.0420	0.10	Q	V				
10+55	0.0427	0.10	Q	V				
11+ 0	0.0434	0.10	Q	V				
11+ 5	0.0441	0.10	Q	V				
11+10	0.0448	0.10	Q	V				
11+15	0.0455	0.10	Q	V				
11+20	0.0462	0.10	Q	V				
11+25	0.0469	0.10	Q	V				
11+30	0.0476	0.10	Q	V				
11+35	0.0482	0.10	Q	V				
11+40	0.0489	0.10	Q	V				
11+45	0.0496	0.09	Q	V				
11+50	0.0502	0.09	Q	V				
11+55	0.0509	0.09	Q	V				
12+ 0	0.0515	0.09	Q	V				
12+ 5	0.0522	0.10	Q	V				
12+10	0.0529	0.10	Q	V				
12+15	0.0537	0.12	Q	V				
12+20	0.0545	0.12	Q	V				
12+25	0.0554	0.13	Q	V				
12+30	0.0563	0.13	Q	V				
12+35	0.0572	0.13	Q	V				
12+40	0.0581	0.13	Q	V				
12+45	0.0591	0.14	Q	V				
12+50	0.0600	0.14	Q	V				
12+55	0.0610	0.14	Q	V				
13+ 0	0.0620	0.15	Q	V				
13+ 5	0.0631	0.15	Q	V				
13+10	0.0643	0.18	Q	V				
13+15	0.0657	0.21	Q	V				
13+20	0.0673	0.23	Q	V				
13+25	0.0689	0.24	Q	V				
13+30	0.0707	0.25	Q	V				
13+35	0.0724	0.25	Q	V				
13+40	0.0739	0.22	Q	V				
13+45	0.0752	0.18	Q	V				
13+50	0.0763	0.16	Q	V				
13+55	0.0773	0.15	Q	V				
14+ 0	0.0783	0.14	Q	V				
14+ 5	0.0793	0.14	Q	V				
14+10	0.0802	0.14	Q	V				
14+15	0.0812	0.14	Q	V				
14+20	0.0822	0.14	Q	V				
14+25	0.0832	0.14	Q	V				
14+30	0.0842	0.14	Q	V				
14+35	0.0851	0.14	Q	V				
14+40	0.0861	0.14	Q	V				
14+45	0.0871	0.14	Q	V				
14+50	0.0880	0.14	Q	V				
14+55	0.0889	0.14	Q	V				
15+ 0	0.0899	0.13	Q	V				
15+ 5	0.0908	0.13	Q	V				

15+10	0.0917	0.13	Q			V	
15+15	0.0926	0.13	Q			V	
15+20	0.0935	0.13	Q			V	
15+25	0.0943	0.13	Q			V	
15+30	0.0952	0.13	Q			V	
15+35	0.0961	0.12	Q			V	
15+40	0.0969	0.12	Q			V	
15+45	0.0976	0.11	Q			V	
15+50	0.0984	0.11	Q			V	
15+55	0.0991	0.11	Q			V	
16+ 0	0.0998	0.10	Q			V	
16+ 5	0.1005	0.10	Q			V	
16+10	0.1011	0.08	Q			V	
16+15	0.1015	0.06	Q			V	
16+20	0.1018	0.05	Q			V	
16+25	0.1021	0.04	Q			V	
16+30	0.1023	0.04	Q			V	
16+35	0.1025	0.03	Q			V	
16+40	0.1027	0.03	Q			V	
16+45	0.1029	0.03	Q			V	
16+50	0.1031	0.02	Q			V	
16+55	0.1032	0.02	Q			V	
17+ 0	0.1034	0.02	Q			V	
17+ 5	0.1035	0.02	Q			V	
17+10	0.1036	0.02	Q			V	
17+15	0.1038	0.02	Q			V	
17+20	0.1040	0.02	Q			V	
17+25	0.1041	0.02	Q			V	
17+30	0.1043	0.02	Q			V	
17+35	0.1045	0.03	Q			V	
17+40	0.1047	0.03	Q			V	
17+45	0.1048	0.03	Q			V	
17+50	0.1050	0.03	Q			V	
17+55	0.1052	0.02	Q			V	
18+ 0	0.1053	0.02	Q			V	
18+ 5	0.1055	0.02	Q			V	
18+10	0.1056	0.02	Q			V	
18+15	0.1058	0.02	Q			V	
18+20	0.1059	0.02	Q			V	
18+25	0.1061	0.02	Q			V	
18+30	0.1062	0.02	Q			V	
18+35	0.1064	0.02	Q			V	
18+40	0.1065	0.02	Q			V	
18+45	0.1067	0.02	Q			V	
18+50	0.1068	0.02	Q			V	
18+55	0.1069	0.02	Q			V	
19+ 0	0.1070	0.01	Q			V	
19+ 5	0.1071	0.01	Q			V	
19+10	0.1072	0.01	Q			V	
19+15	0.1073	0.01	Q			V	
19+20	0.1074	0.02	Q			V	
19+25	0.1075	0.02	Q			V	
19+30	0.1076	0.02	Q			V	
19+35	0.1077	0.02	Q			V	
19+40	0.1079	0.02	Q			V	
19+45	0.1080	0.02	Q			V	
19+50	0.1081	0.02	Q			V	
19+55	0.1082	0.01	Q			V	
20+ 0	0.1083	0.01	Q			V	
20+ 5	0.1084	0.01	Q			V	

20+10	0.1085	0.01	Q				V
20+15	0.1086	0.01	Q				V
20+20	0.1087	0.02	Q				V
20+25	0.1088	0.02	Q				V
20+30	0.1089	0.02	Q				V
20+35	0.1090	0.02	Q				V
20+40	0.1091	0.02	Q				V
20+45	0.1092	0.02	Q				V
20+50	0.1093	0.02	Q				V
20+55	0.1094	0.01	Q				V
21+ 0	0.1095	0.01	Q				V
21+ 5	0.1096	0.01	Q				V
21+10	0.1097	0.01	Q				V
21+15	0.1098	0.01	Q				V
21+20	0.1099	0.01	Q				V
21+25	0.1100	0.01	Q				V
21+30	0.1101	0.01	Q				V
21+35	0.1101	0.01	Q				V
21+40	0.1102	0.01	Q				V
21+45	0.1103	0.01	Q				V
21+50	0.1104	0.01	Q				V
21+55	0.1105	0.01	Q				V
22+ 0	0.1106	0.01	Q				V
22+ 5	0.1107	0.01	Q				V
22+10	0.1108	0.01	Q				V
22+15	0.1109	0.01	Q				V
22+20	0.1110	0.01	Q				V
22+25	0.1111	0.01	Q				V
22+30	0.1112	0.01	Q				V
22+35	0.1112	0.01	Q				V
22+40	0.1113	0.01	Q				V
22+45	0.1114	0.01	Q				V
22+50	0.1115	0.01	Q				V
22+55	0.1115	0.01	Q				V
23+ 0	0.1116	0.01	Q				V
23+ 5	0.1117	0.01	Q				V
23+10	0.1118	0.01	Q				V
23+15	0.1118	0.01	Q				V
23+20	0.1119	0.01	Q				V
23+25	0.1120	0.01	Q				V
23+30	0.1121	0.01	Q				V
23+35	0.1121	0.01	Q				V
23+40	0.1122	0.01	Q				V
23+45	0.1123	0.01	Q				V
23+50	0.1123	0.01	Q				V
23+55	0.1124	0.01	Q				V
24+ 0	0.1125	0.01	Q				V
24+ 5	0.1126	0.01	Q				V
24+10	0.1126	0.01	Q				V
24+15	0.1126	0.00	Q				V
24+20	0.1127	0.00	Q				V
24+25	0.1127	0.00	Q				V
24+30	0.1127	0.00	Q				V
24+35	0.1127	0.00	Q				V
24+40	0.1127	0.00	Q				V
24+45	0.1127	0.00	Q				V
24+50	0.1127	0.00	Q				V
24+55	0.1127	0.00	Q				V
25+ 0	0.1127	0.00	Q				V
25+ 5	0.1127	0.00	Q				V

25+10	0.1127	0.00	Q				V
25+15	0.1127	0.00	Q				V
25+20	0.1127	0.00	Q				V
25+25	0.1127	0.00	Q				V
25+30	0.1127	0.00	Q				V

Unit Hydrograph Analysis

Copyright (c) CIVILCADD/CIVILDESIGN, 1989 - 2004, Version 7.0
Study date 12/08/21 File: 2242.out

+++++

Riverside County Synthetic Unit Hydrology Method
RCFC & WCD Manual date - April 1978

Program License Serial Number 4042

English (in-lb) Input Units Used
English Rainfall Data (Inches) Input Values Used

English Units used in output format

1494-0006 OLD 215 FRONTAGE ROAD
PROPOSED CONDITION
2-YEAR, 24-HOUR STORM EVENT

Drainage Area = 7.07(Ac.) = 0.011 Sq. Mi.
Drainage Area for Depth-Area Areal Adjustment = 7.07(Ac.) = 0.011
Sq. Mi.

USER Entry of lag time in hours
Lag time = 0.105 Hr.
Lag time = 6.27 Min.
25% of lag time = 1.57 Min.
40% of lag time = 2.51 Min.
Unit time = 5.00 Min.
Duration of storm = 24 Hour(s)
User Entered Base Flow = 0.00 (CFS)

2 YEAR Area rainfall data:

Area(Ac.) [1]	Rainfall(In) [2]	Weighting[1*2]
7.07	1.85	13.08

100 YEAR Area rainfall data:

Area(Ac.) [1]	Rainfall(In) [2]	Weighting[1*2]
7.07	4.52	31.96

STORM EVENT (YEAR) = 2.00
Area Averaged 2-Year Rainfall = 1.850 (In)
Area Averaged 100-Year Rainfall = 4.520 (In)

Point rain (area averaged) = 1.850 (In)
Areal adjustment factor = 100.00 %

Adjusted average point rain = 1.850 (In)

Sub-Area Data:

Area (Ac.)	Runoff Index	Impervious %
6.360	98.00	1.000
0.710	69.00	0.000
Total Area Entered = 7.07 (Ac.)		

RI	RI	Infil. Rate	Impervious	Adj. Infil. Rate	Area%	F
AMC2	AMC-1	(In/Hr)	(Dec.%)	(In/Hr)	(Dec.)	(In/Hr)
98.0	94.8	0.068	1.000	0.007	0.900	0.006
69.0	49.8	0.574	0.000	0.574	0.100	0.058
Sum (F) =						0.064

Area averaged mean soil loss (F) (In/Hr) = 0.064

Minimum soil loss rate ((In/Hr)) = 0.032

(for 24 hour storm duration)

Soil low loss rate (decimal) = 0.180

Unit Hydrograph
VALLEY S-Curve

Unit Hydrograph Data

Unit time period (hrs)	Time % of lag	Distribution Graph %	Unit Hydrograph (CFS)
1	0.083	79.745	13.229
2	0.167	159.490	44.331
3	0.250	239.234	20.009
4	0.333	318.979	8.262
5	0.417	398.724	4.961
6	0.500	478.469	3.132
7	0.583	558.214	2.254
8	0.667	637.959	1.551
9	0.750	717.703	1.045
10	0.833	797.448	0.801
11	0.917	877.193	0.424
Sum = 100.000			Sum= 7.125

Unit Time (Hr.)	Pattern Percent	Storm Rain (In/Hr)	Loss rate (In./Hr)		Effective (In/Hr)	
			Max	Low		
1	0.08	0.07	0.015	0.113	0.003	0.01
2	0.17	0.07	0.015	0.113	0.003	0.01
3	0.25	0.07	0.015	0.112	0.003	0.01
4	0.33	0.10	0.022	0.112	0.004	0.02
5	0.42	0.10	0.022	0.111	0.004	0.02
6	0.50	0.10	0.022	0.111	0.004	0.02
7	0.58	0.10	0.022	0.110	0.004	0.02
8	0.67	0.10	0.022	0.110	0.004	0.02
9	0.75	0.10	0.022	0.109	0.004	0.02
10	0.83	0.13	0.030	0.109	0.005	0.02
11	0.92	0.13	0.030	0.109	0.005	0.02
12	1.00	0.13	0.030	0.108	0.005	0.02
13	1.08	0.10	0.022	0.108	0.004	0.02
14	1.17	0.10	0.022	0.107	0.004	0.02
15	1.25	0.10	0.022	0.107	0.004	0.02

16	1.33	0.10	0.022	0.106	0.004	0.02
17	1.42	0.10	0.022	0.106	0.004	0.02
18	1.50	0.10	0.022	0.106	0.004	0.02
19	1.58	0.10	0.022	0.105	0.004	0.02
20	1.67	0.10	0.022	0.105	0.004	0.02
21	1.75	0.10	0.022	0.104	0.004	0.02
22	1.83	0.13	0.030	0.104	0.005	0.02
23	1.92	0.13	0.030	0.104	0.005	0.02
24	2.00	0.13	0.030	0.103	0.005	0.02
25	2.08	0.13	0.030	0.103	0.005	0.02
26	2.17	0.13	0.030	0.102	0.005	0.02
27	2.25	0.13	0.030	0.102	0.005	0.02
28	2.33	0.13	0.030	0.101	0.005	0.02
29	2.42	0.13	0.030	0.101	0.005	0.02
30	2.50	0.13	0.030	0.101	0.005	0.02
31	2.58	0.17	0.037	0.100	0.007	0.03
32	2.67	0.17	0.037	0.100	0.007	0.03
33	2.75	0.17	0.037	0.099	0.007	0.03
34	2.83	0.17	0.037	0.099	0.007	0.03
35	2.92	0.17	0.037	0.099	0.007	0.03
36	3.00	0.17	0.037	0.098	0.007	0.03
37	3.08	0.17	0.037	0.098	0.007	0.03
38	3.17	0.17	0.037	0.097	0.007	0.03
39	3.25	0.17	0.037	0.097	0.007	0.03
40	3.33	0.17	0.037	0.097	0.007	0.03
41	3.42	0.17	0.037	0.096	0.007	0.03
42	3.50	0.17	0.037	0.096	0.007	0.03
43	3.58	0.17	0.037	0.095	0.007	0.03
44	3.67	0.17	0.037	0.095	0.007	0.03
45	3.75	0.17	0.037	0.095	0.007	0.03
46	3.83	0.20	0.044	0.094	0.008	0.04
47	3.92	0.20	0.044	0.094	0.008	0.04
48	4.00	0.20	0.044	0.093	0.008	0.04
49	4.08	0.20	0.044	0.093	0.008	0.04
50	4.17	0.20	0.044	0.093	0.008	0.04
51	4.25	0.20	0.044	0.092	0.008	0.04
52	4.33	0.23	0.052	0.092	0.009	0.04
53	4.42	0.23	0.052	0.091	0.009	0.04
54	4.50	0.23	0.052	0.091	0.009	0.04
55	4.58	0.23	0.052	0.091	0.009	0.04
56	4.67	0.23	0.052	0.090	0.009	0.04
57	4.75	0.23	0.052	0.090	0.009	0.04
58	4.83	0.27	0.059	0.089	0.011	0.05
59	4.92	0.27	0.059	0.089	0.011	0.05
60	5.00	0.27	0.059	0.089	0.011	0.05
61	5.08	0.20	0.044	0.088	0.008	0.04
62	5.17	0.20	0.044	0.088	0.008	0.04
63	5.25	0.20	0.044	0.088	0.008	0.04
64	5.33	0.23	0.052	0.087	0.009	0.04
65	5.42	0.23	0.052	0.087	0.009	0.04
66	5.50	0.23	0.052	0.086	0.009	0.04
67	5.58	0.27	0.059	0.086	0.011	0.05
68	5.67	0.27	0.059	0.086	0.011	0.05
69	5.75	0.27	0.059	0.085	0.011	0.05
70	5.83	0.27	0.059	0.085	0.011	0.05
71	5.92	0.27	0.059	0.084	0.011	0.05
72	6.00	0.27	0.059	0.084	0.011	0.05
73	6.08	0.30	0.067	0.084	0.012	0.05
74	6.17	0.30	0.067	0.083	0.012	0.05
75	6.25	0.30	0.067	0.083	0.012	0.05

76	6.33	0.30	0.067	0.083	0.012	0.05
77	6.42	0.30	0.067	0.082	0.012	0.05
78	6.50	0.30	0.067	0.082	0.012	0.05
79	6.58	0.33	0.074	0.082	0.013	0.06
80	6.67	0.33	0.074	0.081	0.013	0.06
81	6.75	0.33	0.074	0.081	0.013	0.06
82	6.83	0.33	0.074	0.080	0.013	0.06
83	6.92	0.33	0.074	0.080	0.013	0.06
84	7.00	0.33	0.074	0.080	0.013	0.06
85	7.08	0.33	0.074	0.079	0.013	0.06
86	7.17	0.33	0.074	0.079	0.013	0.06
87	7.25	0.33	0.074	0.079	0.013	0.06
88	7.33	0.37	0.081	0.078	---	0.00
89	7.42	0.37	0.081	0.078	---	0.00
90	7.50	0.37	0.081	0.078	---	0.00
91	7.58	0.40	0.089	0.077	---	0.01
92	7.67	0.40	0.089	0.077	---	0.01
93	7.75	0.40	0.089	0.076	---	0.01
94	7.83	0.43	0.096	0.076	---	0.02
95	7.92	0.43	0.096	0.076	---	0.02
96	8.00	0.43	0.096	0.075	---	0.02
97	8.08	0.50	0.111	0.075	---	0.04
98	8.17	0.50	0.111	0.075	---	0.04
99	8.25	0.50	0.111	0.074	---	0.04
100	8.33	0.50	0.111	0.074	---	0.04
101	8.42	0.50	0.111	0.074	---	0.04
102	8.50	0.50	0.111	0.073	---	0.04
103	8.58	0.53	0.118	0.073	---	0.05
104	8.67	0.53	0.118	0.073	---	0.05
105	8.75	0.53	0.118	0.072	---	0.05
106	8.83	0.57	0.126	0.072	---	0.05
107	8.92	0.57	0.126	0.072	---	0.05
108	9.00	0.57	0.126	0.071	---	0.05
109	9.08	0.63	0.141	0.071	---	0.07
110	9.17	0.63	0.141	0.071	---	0.07
111	9.25	0.63	0.141	0.070	---	0.07
112	9.33	0.67	0.148	0.070	---	0.08
113	9.42	0.67	0.148	0.070	---	0.08
114	9.50	0.67	0.148	0.069	---	0.08
115	9.58	0.70	0.155	0.069	---	0.09
116	9.67	0.70	0.155	0.069	---	0.09
117	9.75	0.70	0.155	0.068	---	0.09
118	9.83	0.73	0.163	0.068	---	0.09
119	9.92	0.73	0.163	0.068	---	0.10
120	10.00	0.73	0.163	0.067	---	0.10
121	10.08	0.50	0.111	0.067	---	0.04
122	10.17	0.50	0.111	0.067	---	0.04
123	10.25	0.50	0.111	0.066	---	0.04
124	10.33	0.50	0.111	0.066	---	0.05
125	10.42	0.50	0.111	0.066	---	0.05
126	10.50	0.50	0.111	0.065	---	0.05
127	10.58	0.67	0.148	0.065	---	0.08
128	10.67	0.67	0.148	0.065	---	0.08
129	10.75	0.67	0.148	0.064	---	0.08
130	10.83	0.67	0.148	0.064	---	0.08
131	10.92	0.67	0.148	0.064	---	0.08
132	11.00	0.67	0.148	0.063	---	0.08
133	11.08	0.63	0.141	0.063	---	0.08
134	11.17	0.63	0.141	0.063	---	0.08
135	11.25	0.63	0.141	0.063	---	0.08

136	11.33	0.63	0.141	0.062	---	0.08
137	11.42	0.63	0.141	0.062	---	0.08
138	11.50	0.63	0.141	0.062	---	0.08
139	11.58	0.57	0.126	0.061	---	0.06
140	11.67	0.57	0.126	0.061	---	0.06
141	11.75	0.57	0.126	0.061	---	0.07
142	11.83	0.60	0.133	0.060	---	0.07
143	11.92	0.60	0.133	0.060	---	0.07
144	12.00	0.60	0.133	0.060	---	0.07
145	12.08	0.83	0.185	0.059	---	0.13
146	12.17	0.83	0.185	0.059	---	0.13
147	12.25	0.83	0.185	0.059	---	0.13
148	12.33	0.87	0.192	0.059	---	0.13
149	12.42	0.87	0.192	0.058	---	0.13
150	12.50	0.87	0.192	0.058	---	0.13
151	12.58	0.93	0.207	0.058	---	0.15
152	12.67	0.93	0.207	0.057	---	0.15
153	12.75	0.93	0.207	0.057	---	0.15
154	12.83	0.97	0.215	0.057	---	0.16
155	12.92	0.97	0.215	0.057	---	0.16
156	13.00	0.97	0.215	0.056	---	0.16
157	13.08	1.13	0.252	0.056	---	0.20
158	13.17	1.13	0.252	0.056	---	0.20
159	13.25	1.13	0.252	0.055	---	0.20
160	13.33	1.13	0.252	0.055	---	0.20
161	13.42	1.13	0.252	0.055	---	0.20
162	13.50	1.13	0.252	0.055	---	0.20
163	13.58	0.77	0.170	0.054	---	0.12
164	13.67	0.77	0.170	0.054	---	0.12
165	13.75	0.77	0.170	0.054	---	0.12
166	13.83	0.77	0.170	0.053	---	0.12
167	13.92	0.77	0.170	0.053	---	0.12
168	14.00	0.77	0.170	0.053	---	0.12
169	14.08	0.90	0.200	0.053	---	0.15
170	14.17	0.90	0.200	0.052	---	0.15
171	14.25	0.90	0.200	0.052	---	0.15
172	14.33	0.87	0.192	0.052	---	0.14
173	14.42	0.87	0.192	0.052	---	0.14
174	14.50	0.87	0.192	0.051	---	0.14
175	14.58	0.87	0.192	0.051	---	0.14
176	14.67	0.87	0.192	0.051	---	0.14
177	14.75	0.87	0.192	0.051	---	0.14
178	14.83	0.83	0.185	0.050	---	0.13
179	14.92	0.83	0.185	0.050	---	0.13
180	15.00	0.83	0.185	0.050	---	0.14
181	15.08	0.80	0.178	0.050	---	0.13
182	15.17	0.80	0.178	0.049	---	0.13
183	15.25	0.80	0.178	0.049	---	0.13
184	15.33	0.77	0.170	0.049	---	0.12
185	15.42	0.77	0.170	0.049	---	0.12
186	15.50	0.77	0.170	0.048	---	0.12
187	15.58	0.63	0.141	0.048	---	0.09
188	15.67	0.63	0.141	0.048	---	0.09
189	15.75	0.63	0.141	0.048	---	0.09
190	15.83	0.63	0.141	0.047	---	0.09
191	15.92	0.63	0.141	0.047	---	0.09
192	16.00	0.63	0.141	0.047	---	0.09
193	16.08	0.13	0.030	0.047	0.005	0.02
194	16.17	0.13	0.030	0.046	0.005	0.02
195	16.25	0.13	0.030	0.046	0.005	0.02

196	16.33	0.13	0.030	0.046	0.005	0.02
197	16.42	0.13	0.030	0.046	0.005	0.02
198	16.50	0.13	0.030	0.045	0.005	0.02
199	16.58	0.10	0.022	0.045	0.004	0.02
200	16.67	0.10	0.022	0.045	0.004	0.02
201	16.75	0.10	0.022	0.045	0.004	0.02
202	16.83	0.10	0.022	0.044	0.004	0.02
203	16.92	0.10	0.022	0.044	0.004	0.02
204	17.00	0.10	0.022	0.044	0.004	0.02
205	17.08	0.17	0.037	0.044	0.007	0.03
206	17.17	0.17	0.037	0.044	0.007	0.03
207	17.25	0.17	0.037	0.043	0.007	0.03
208	17.33	0.17	0.037	0.043	0.007	0.03
209	17.42	0.17	0.037	0.043	0.007	0.03
210	17.50	0.17	0.037	0.043	0.007	0.03
211	17.58	0.17	0.037	0.042	0.007	0.03
212	17.67	0.17	0.037	0.042	0.007	0.03
213	17.75	0.17	0.037	0.042	0.007	0.03
214	17.83	0.13	0.030	0.042	0.005	0.02
215	17.92	0.13	0.030	0.042	0.005	0.02
216	18.00	0.13	0.030	0.041	0.005	0.02
217	18.08	0.13	0.030	0.041	0.005	0.02
218	18.17	0.13	0.030	0.041	0.005	0.02
219	18.25	0.13	0.030	0.041	0.005	0.02
220	18.33	0.13	0.030	0.041	0.005	0.02
221	18.42	0.13	0.030	0.040	0.005	0.02
222	18.50	0.13	0.030	0.040	0.005	0.02
223	18.58	0.10	0.022	0.040	0.004	0.02
224	18.67	0.10	0.022	0.040	0.004	0.02
225	18.75	0.10	0.022	0.040	0.004	0.02
226	18.83	0.07	0.015	0.039	0.003	0.01
227	18.92	0.07	0.015	0.039	0.003	0.01
228	19.00	0.07	0.015	0.039	0.003	0.01
229	19.08	0.10	0.022	0.039	0.004	0.02
230	19.17	0.10	0.022	0.039	0.004	0.02
231	19.25	0.10	0.022	0.039	0.004	0.02
232	19.33	0.13	0.030	0.038	0.005	0.02
233	19.42	0.13	0.030	0.038	0.005	0.02
234	19.50	0.13	0.030	0.038	0.005	0.02
235	19.58	0.10	0.022	0.038	0.004	0.02
236	19.67	0.10	0.022	0.038	0.004	0.02
237	19.75	0.10	0.022	0.038	0.004	0.02
238	19.83	0.07	0.015	0.037	0.003	0.01
239	19.92	0.07	0.015	0.037	0.003	0.01
240	20.00	0.07	0.015	0.037	0.003	0.01
241	20.08	0.10	0.022	0.037	0.004	0.02
242	20.17	0.10	0.022	0.037	0.004	0.02
243	20.25	0.10	0.022	0.037	0.004	0.02
244	20.33	0.10	0.022	0.036	0.004	0.02
245	20.42	0.10	0.022	0.036	0.004	0.02
246	20.50	0.10	0.022	0.036	0.004	0.02
247	20.58	0.10	0.022	0.036	0.004	0.02
248	20.67	0.10	0.022	0.036	0.004	0.02
249	20.75	0.10	0.022	0.036	0.004	0.02
250	20.83	0.07	0.015	0.035	0.003	0.01
251	20.92	0.07	0.015	0.035	0.003	0.01
252	21.00	0.07	0.015	0.035	0.003	0.01
253	21.08	0.10	0.022	0.035	0.004	0.02
254	21.17	0.10	0.022	0.035	0.004	0.02
255	21.25	0.10	0.022	0.035	0.004	0.02

256	21.33	0.07	0.015	0.035	0.003	0.01
257	21.42	0.07	0.015	0.034	0.003	0.01
258	21.50	0.07	0.015	0.034	0.003	0.01
259	21.58	0.10	0.022	0.034	0.004	0.02
260	21.67	0.10	0.022	0.034	0.004	0.02
261	21.75	0.10	0.022	0.034	0.004	0.02
262	21.83	0.07	0.015	0.034	0.003	0.01
263	21.92	0.07	0.015	0.034	0.003	0.01
264	22.00	0.07	0.015	0.034	0.003	0.01
265	22.08	0.10	0.022	0.034	0.004	0.02
266	22.17	0.10	0.022	0.033	0.004	0.02
267	22.25	0.10	0.022	0.033	0.004	0.02
268	22.33	0.07	0.015	0.033	0.003	0.01
269	22.42	0.07	0.015	0.033	0.003	0.01
270	22.50	0.07	0.015	0.033	0.003	0.01
271	22.58	0.07	0.015	0.033	0.003	0.01
272	22.67	0.07	0.015	0.033	0.003	0.01
273	22.75	0.07	0.015	0.033	0.003	0.01
274	22.83	0.07	0.015	0.033	0.003	0.01
275	22.92	0.07	0.015	0.033	0.003	0.01
276	23.00	0.07	0.015	0.032	0.003	0.01
277	23.08	0.07	0.015	0.032	0.003	0.01
278	23.17	0.07	0.015	0.032	0.003	0.01
279	23.25	0.07	0.015	0.032	0.003	0.01
280	23.33	0.07	0.015	0.032	0.003	0.01
281	23.42	0.07	0.015	0.032	0.003	0.01
282	23.50	0.07	0.015	0.032	0.003	0.01
283	23.58	0.07	0.015	0.032	0.003	0.01
284	23.67	0.07	0.015	0.032	0.003	0.01
285	23.75	0.07	0.015	0.032	0.003	0.01
286	23.83	0.07	0.015	0.032	0.003	0.01
287	23.92	0.07	0.015	0.032	0.003	0.01
288	24.00	0.07	0.015	0.032	0.003	0.01

Sum = 100.0 Sum = 14.7

Flood volume = Effective rainfall 1.22 (In)
times area 7.1 (Ac.) / [(In) / (Ft.)] = 0.7 (Ac.Ft)
Total soil loss = 0.63 (In)
Total soil loss = 0.369 (Ac.Ft)
Total rainfall = 1.85 (In)
Flood volume = 31401.1 Cubic Feet
Total soil loss = 16076.8 Cubic Feet

Peak flow rate of this hydrograph = 1.384 (CFS)

+++++
24 - H O U R S T O R M
R u n o f f H y d r o g r a p h

Hydrograph in 5 Minute intervals ((CFS))

Time (h+m)	Volume Ac.Ft	Q (CFS)	0	2.5	5.0	7.5	10.0
0+ 5	0.0001	0.01	Q				
0+10	0.0004	0.05	Q				
0+15	0.0009	0.07	Q				
0+20	0.0014	0.08	Q				
0+25	0.0021	0.10	Q				
0+30	0.0029	0.11	Q				
0+35	0.0038	0.12	Q				

0+40	0.0046	0.12	Q				
0+45	0.0055	0.13	Q				
0+50	0.0064	0.13	Q				
0+55	0.0075	0.15	Q				
1+ 0	0.0086	0.16	Q				
1+ 5	0.0097	0.16	Q				
1+10	0.0107	0.14	Q				
1+15	0.0116	0.14	Q				
1+20	0.0126	0.13	Q				
1+25	0.0135	0.13	Q				
1+30	0.0144	0.13	Q				
1+35	0.0153	0.13	Q				
1+40	0.0162	0.13	Q				
1+45	0.0171	0.13	Q				
1+50	0.0180	0.14	Q				
1+55	0.0191	0.15	QV				
2+ 0	0.0202	0.16	QV				
2+ 5	0.0214	0.17	QV				
2+10	0.0225	0.17	QV				
2+15	0.0237	0.17	QV				
2+20	0.0249	0.17	QV				
2+25	0.0261	0.17	QV				
2+30	0.0272	0.17	QV				
2+35	0.0285	0.18	QV				
2+40	0.0298	0.20	QV				
2+45	0.0313	0.21	QV				
2+50	0.0327	0.21	QV				
2+55	0.0342	0.21	QV				
3+ 0	0.0356	0.21	QV				
3+ 5	0.0371	0.21	Q V				
3+10	0.0386	0.22	Q V				
3+15	0.0401	0.22	Q V				
3+20	0.0416	0.22	Q V				
3+25	0.0431	0.22	Q V				
3+30	0.0446	0.22	Q V				
3+35	0.0460	0.22	Q V				
3+40	0.0475	0.22	Q V				
3+45	0.0490	0.22	Q V				
3+50	0.0506	0.22	Q V				
3+55	0.0522	0.24	Q V				
4+ 0	0.0539	0.25	Q V				
4+ 5	0.0557	0.25	Q V				
4+10	0.0574	0.26	Q V				
4+15	0.0592	0.26	Q V				
4+20	0.0610	0.26	Q V				
4+25	0.0630	0.28	Q V				
4+30	0.0650	0.29	Q V				
4+35	0.0670	0.30	Q V				
4+40	0.0691	0.30	Q V				
4+45	0.0712	0.30	Q V				
4+50	0.0733	0.31	Q V				
4+55	0.0755	0.33	Q V				
5+ 0	0.0778	0.34	Q V				
5+ 5	0.0801	0.33	Q V				
5+10	0.0821	0.29	Q V				
5+15	0.0840	0.28	Q V				
5+20	0.0859	0.28	Q V				
5+25	0.0879	0.29	Q V				
5+30	0.0900	0.30	Q V				
5+35	0.0921	0.31	Q V				

5+40	0.0943	0.33	Q	V				
5+45	0.0966	0.33	Q	V				
5+50	0.0990	0.34	Q	V				
5+55	0.1013	0.34	Q	V				
6+ 0	0.1037	0.34	Q	V				
6+ 5	0.1061	0.35	Q	V				
6+10	0.1086	0.37	Q	V				
6+15	0.1112	0.38	Q	V				
6+20	0.1139	0.38	Q	V				
6+25	0.1165	0.39	Q	V				
6+30	0.1192	0.39	Q	V				
6+35	0.1219	0.39	Q	V				
6+40	0.1247	0.41	Q	V				
6+45	0.1277	0.42	Q	V				
6+50	0.1306	0.43	Q	V				
6+55	0.1335	0.43	Q	V				
7+ 0	0.1365	0.43	Q	V				
7+ 5	0.1395	0.43	Q	V				
7+10	0.1424	0.43	Q	V				
7+15	0.1454	0.43	Q	V				
7+20	0.1480	0.38	Q	V				
7+25	0.1494	0.20	Q	V				
7+30	0.1502	0.12	Q	V				
7+35	0.1508	0.09	Q	V				
7+40	0.1515	0.10	Q	V				
7+45	0.1521	0.10	Q	V				
7+50	0.1528	0.10	Q	V				
7+55	0.1537	0.12	Q	V				
8+ 0	0.1546	0.13	Q	V				
8+ 5	0.1557	0.15	Q	V				
8+10	0.1570	0.20	Q	V				
8+15	0.1586	0.23	Q	V				
8+20	0.1603	0.24	Q	V				
8+25	0.1620	0.25	Q	V				
8+30	0.1638	0.26	Q	V				
8+35	0.1656	0.27	Q	V				
8+40	0.1677	0.30	Q	V				
8+45	0.1698	0.31	Q	V				
8+50	0.1721	0.33	Q	V				
8+55	0.1745	0.35	Q	V				
9+ 0	0.1770	0.37	Q	V				
9+ 5	0.1797	0.39	Q	V				
9+10	0.1828	0.44	Q	V				
9+15	0.1860	0.47	Q	V				
9+20	0.1894	0.49	Q	V				
9+25	0.1930	0.52	Q	V				
9+30	0.1967	0.54	Q	V				
9+35	0.2005	0.55	Q	V				
9+40	0.2045	0.58	Q	V				
9+45	0.2087	0.60	Q	V				
9+50	0.2129	0.62	Q	V				
9+55	0.2174	0.65	Q	V				
10+ 0	0.2219	0.66	Q	V				
10+ 5	0.2262	0.62	Q	V				
10+10	0.2294	0.46	Q	V				
10+15	0.2321	0.39	Q	V				
10+20	0.2346	0.37	Q	V				
10+25	0.2370	0.35	Q	V				
10+30	0.2394	0.34	Q	V				
10+35	0.2419	0.37	Q	V				

10+40	0.2453	0.49	Q		V			
10+45	0.2490	0.54	Q		V			
10+50	0.2528	0.56	Q		V			
10+55	0.2568	0.57	Q		V			
11+ 0	0.2608	0.58	Q		V			
11+ 5	0.2648	0.58	Q		V			
11+10	0.2687	0.57	Q		V			
11+15	0.2726	0.56	Q		V			
11+20	0.2764	0.56	Q		V			
11+25	0.2803	0.56	Q		V			
11+30	0.2842	0.56	Q		V			
11+35	0.2880	0.55	Q		V			
11+40	0.2914	0.50	Q		V			
11+45	0.2948	0.48	Q		V			
11+50	0.2981	0.48	Q		V			
11+55	0.3016	0.50	Q		V			
12+ 0	0.3051	0.51	Q		V			
12+ 5	0.3090	0.57	Q		V			
12+10	0.3141	0.73	Q		V			
12+15	0.3197	0.81	Q		V			
12+20	0.3255	0.85	Q		V			
12+25	0.3317	0.89	Q		V			
12+30	0.3380	0.92	Q		V			
12+35	0.3445	0.95	Q		V			
12+40	0.3515	1.01	Q		V			
12+45	0.3586	1.03	Q		V			
12+50	0.3659	1.06	Q		V			
12+55	0.3734	1.09	Q		V			
13+ 0	0.3810	1.11	Q		V			
13+ 5	0.3889	1.15	Q		V			
13+10	0.3977	1.27	Q		V			
13+15	0.4068	1.33	Q		V			
13+20	0.4162	1.36	Q		V			
13+25	0.4256	1.37	Q		V			
13+30	0.4352	1.38	Q		V			
13+35	0.4442	1.32	Q		V			
13+40	0.4516	1.06	Q		V			
13+45	0.4581	0.95	Q		V			
13+50	0.4644	0.91	Q		V			
13+55	0.4705	0.88	Q		V			
14+ 0	0.4765	0.87	Q		V			
14+ 5	0.4825	0.88	Q		V			
14+10	0.4892	0.97	Q		V			
14+15	0.4962	1.01	Q		V			
14+20	0.5032	1.02	Q		V			
14+25	0.5101	1.00	Q		V			
14+30	0.5170	1.00	Q		V			
14+35	0.5239	1.00	Q		V			
14+40	0.5308	1.01	Q		V			
14+45	0.5378	1.01	Q		V			
14+50	0.5447	1.00	Q		V			
14+55	0.5514	0.98	Q		V			
15+ 0	0.5581	0.97	Q		V			
15+ 5	0.5648	0.96	Q		V			
15+10	0.5712	0.94	Q		V			
15+15	0.5776	0.93	Q		V			
15+20	0.5840	0.92	Q		V			
15+25	0.5901	0.89	Q		V			
15+30	0.5962	0.88	Q		V			
15+35	0.6020	0.85	Q		V			

15+40	0.6072	0.75	Q				V	
15+45	0.6121	0.71	Q				V	
15+50	0.6169	0.69	Q				V	
15+55	0.6216	0.68	Q				V	
16+ 0	0.6263	0.68	Q				V	
16+ 5	0.6305	0.61	Q				V	
16+10	0.6332	0.39	Q				V	
16+15	0.6351	0.29	Q				V	
16+20	0.6368	0.24	Q				V	
16+25	0.6383	0.22	Q				V	
16+30	0.6397	0.20	Q				V	
16+35	0.6410	0.19	Q				V	
16+40	0.6421	0.16	Q				V	
16+45	0.6431	0.15	Q				V	
16+50	0.6440	0.14	Q				V	
16+55	0.6450	0.13	Q				V	
17+ 0	0.6459	0.13	Q				V	
17+ 5	0.6469	0.14	Q				V	
17+10	0.6481	0.18	Q				V	
17+15	0.6495	0.20	Q				V	
17+20	0.6509	0.20	Q				V	
17+25	0.6523	0.21	Q				V	
17+30	0.6538	0.21	Q				V	
17+35	0.6552	0.21	Q				V	
17+40	0.6567	0.21	Q				V	
17+45	0.6582	0.22	Q				V	
17+50	0.6596	0.21	Q				V	
17+55	0.6609	0.19	Q				V	
18+ 0	0.6622	0.18	Q				V	
18+ 5	0.6634	0.18	Q				V	
18+10	0.6647	0.18	Q				V	
18+15	0.6659	0.18	Q				V	
18+20	0.6671	0.17	Q				V	
18+25	0.6683	0.17	Q				V	
18+30	0.6695	0.17	Q				V	
18+35	0.6706	0.17	Q				V	
18+40	0.6716	0.15	Q				V	
18+45	0.6726	0.14	Q				V	
18+50	0.6735	0.13	Q				V	
18+55	0.6742	0.11	Q				V	
19+ 0	0.6749	0.10	Q				V	
19+ 5	0.6756	0.10	Q				V	
19+10	0.6764	0.12	Q				V	
19+15	0.6773	0.12	Q				V	
19+20	0.6782	0.13	Q				V	
19+25	0.6792	0.15	Q				V	
19+30	0.6803	0.16	Q				V	
19+35	0.6814	0.16	Q				V	
19+40	0.6824	0.14	Q				V	
19+45	0.6833	0.14	Q				V	
19+50	0.6842	0.13	Q				V	
19+55	0.6850	0.11	Q				V	
20+ 0	0.6857	0.10	Q				V	
20+ 5	0.6863	0.10	Q				V	
20+10	0.6871	0.12	Q				V	
20+15	0.6880	0.12	Q				V	
20+20	0.6889	0.13	Q				V	
20+25	0.6897	0.13	Q				V	
20+30	0.6906	0.13	Q				V	
20+35	0.6915	0.13	Q				V	

20+40	0.6924	0.13	Q				V	
20+45	0.6933	0.13	Q				V	
20+50	0.6941	0.12	Q				V	
20+55	0.6948	0.10	Q				V	
21+ 0	0.6955	0.10	Q				V	
21+ 5	0.6962	0.10	Q				V	
21+10	0.6970	0.12	Q				V	
21+15	0.6978	0.12	Q				V	
21+20	0.6986	0.12	Q				V	
21+25	0.6993	0.10	Q				V	
21+30	0.7000	0.09	Q				V	
21+35	0.7007	0.10	Q				V	
21+40	0.7014	0.11	Q				V	
21+45	0.7023	0.12	Q				V	
21+50	0.7031	0.12	Q				V	
21+55	0.7038	0.10	Q				V	
22+ 0	0.7045	0.09	Q				V	
22+ 5	0.7051	0.10	Q				V	
22+10	0.7059	0.11	Q				V	
22+15	0.7068	0.12	Q				V	
22+20	0.7076	0.12	Q				V	
22+25	0.7083	0.10	Q				V	
22+30	0.7089	0.09	Q				V	
22+35	0.7096	0.09	Q				V	
22+40	0.7102	0.09	Q				V	
22+45	0.7108	0.09	Q				V	
22+50	0.7114	0.09	Q				V	
22+55	0.7120	0.09	Q				V	
23+ 0	0.7126	0.09	Q				V	
23+ 5	0.7132	0.09	Q				V	
23+10	0.7138	0.09	Q				V	
23+15	0.7144	0.09	Q				V	
23+20	0.7150	0.09	Q				V	
23+25	0.7156	0.09	Q				V	
23+30	0.7162	0.09	Q				V	
23+35	0.7168	0.09	Q				V	
23+40	0.7174	0.09	Q				V	
23+45	0.7180	0.09	Q				V	
23+50	0.7186	0.09	Q				V	
23+55	0.7192	0.09	Q				V	
24+ 0	0.7197	0.09	Q				V	
24+ 5	0.7203	0.08	Q				V	
24+10	0.7205	0.04	Q				V	
24+15	0.7206	0.02	Q				V	
24+20	0.7207	0.01	Q				V	
24+25	0.7208	0.01	Q				V	
24+30	0.7208	0.01	Q				V	
24+35	0.7208	0.00	Q				V	
24+40	0.7209	0.00	Q				V	
24+45	0.7209	0.00	Q				V	
24+50	0.7209	0.00	Q				V	

**PRELIMINARY DRAINAGE ANALYSIS
FOR**

**APN 263-190-012, 014 – 019, 036
OLD 215 / EDGEMONT STREET
PEN21-0325 / LST22-0007**

**CITY OF MORENO VALLEY
RIVERSIDE COUNTY, CALIFORNIA**

Prepared for:

**CDRE HOLDINGS 21, LLC
ATTN: MR. MARK BACHLI
523 Main Street
El Segundo, CA 90245**

**Contact: Mr. Mark Bachli
Tel: (310) 428-3302**

Prepared by:



**1470 East Cooley Drive
Colton, CA 92324
(909) 783-0101 • Fax (909) 783-0108**

**DECEMBER 14, 2021
REVISED MARCH 17, 2022**

**PRELIMINARY DRAINAGE ANALYSIS
OLD 215 INDUSTRIAL BUILDING (PEN21-0325 / LST22-0007)
CITY OF MORENO VALLEY, CA**

This report has been prepared by or under the direction of the following registered civil engineer who attests to the technical information contained herein.



03/17/2022



Patrick C. Flanagan Jr., P.E.
Registered Civil Engineer

Date

Seal

**PRELIMINARY DRAINAGE ANALYSIS
OLD 215 INDUSTRIAL BUILDING (PEN21-0325 / LST22-0007)
CITY OF MORENO VALLEY, CA**

TABLE OF CONTENTS

I.	PURPOSE AND SCOPE.....	1
II.	PROJECT DESCRIPTION	1
III.	DRAINAGE AREA OVERVIEW	1
IV.	HYDROLOGY.....	3
V.	STUDY FINDINGS	3
VI.	CONCLUSION	4
VII.	REFERENCES.....	4

**PRELIMINARY DRAINAGE ANALYSIS
OLD 215 INDUSTRIAL BUILDING (PEN21-0325 / LST22-0007)
CITY OF MORENO VALLEY, CA**

FIGURES

FIGURE 1:	REGIONAL VICINITY MAP
FIGURE 2:	LOCAL VICINITY MAP
FIGURE 3:	FEMA FLOODPLAIN MAP

APPENDICES

APPENDIX A:	ON-SITE HYDROLOGY BASED ON EXISTING CONDITION (RATIONAL METHOD)
APPENDIX A.1:	10-YEAR HYDROLOGY CALCULATIONS (EXISTING)
APPENDIX A.2:	100-YEAR HYDROLOGY CALCULATIONS (EXISTING)
APPENDIX B:	ON-SITE HYDROLOGY BASED ON PROPOSED CONDITION (RATIONAL METHOD)
APPENDIX B.1:	10-YEAR HYDROLOGY CALCULATIONS (PROPOSED)
APPENDIX B.2:	100-YEAR HYDROLOGY CALCULATIONS (PROPOSED)
APPENDIX C:	ON-SITE HYDROLOGY BASED ON EXISTING CONDITION (UNIT HYDROGRAPH)
APPENDIX C.1:	10-YEAR HYDROLOGY CALCULATIONS (EXISTING)
APPENDIX D:	ON-SITE HYDROLOGY BASED ON PROPOSED CONDITION (UNIT HYDROGRAPH)
APPENDIX D.1:	10-YEAR HYDROLOGY CALCULATIONS (PROPOSED)
APPENDIX E:	OFF-SITE HYDROLOGY BASED ON EXISTING CONDITION FOR PUBLIC STORM DRAIN
APPENDIX E.1:	100-YEAR HYDROLOGY CALCULATIONS (AREA B1, OLD 215)
APPENDIX E.2:	100-YEAR HYDROLOGY CALCULATIONS (AREA B2, EDGEMONT)
APPENDIX E.3:	NORMAL DEPTH CALCULATIONS FOR STORM DRAIN
APPENDIX F:	REFERENCES
	<ul style="list-style-type: none">• NATIONAL RESOURCES CONSERVATION SERVICE WEB SOIL SURVEY• NOAA PRECIPITATION FREQUENCY DATA SERVER• RCFC&WCD HYDROLOGY MANUAL RUNOFF INDEX NUMBERS (PLATE D-5.5)

**PRELIMINARY DRAINAGE ANALYSIS
OLD 215 INDUSTRIAL BUILDING (PEN21-0325 / LST22-0007)
CITY OF MORENO VALLEY, CA**

EXHIBITS

- EXHIBIT A: HYDROLOGY MAP – EXISTING CONDITION (RATIONAL)**
- EXHIBIT B: HYDROLOGY MAP – PROPOSED CONDITION (RATIONAL)**

**PRELIMINARY DRAINAGE ANALYSIS
OLD 215 INDUSTRIAL BUILDING (PEN21-0325 / LST22-0007)
CITY OF MORENO VALLEY, CA**

I. PURPOSE AND SCOPE

The purpose of this drainage analysis is to quantify the 100-year storm event runoff emanating from the on-site drainage areas for the proposed industrial warehouse development located in the City of Moreno Valley, Riverside County, California. The study will analyze the existing and proposed hydrologic conditions of the Project's drainage areas and determine the necessary drainage improvements to convey the 100-year Project flows through the property.

The scope of this analysis includes the following:

1. Determination of points of flow concentration and drainage areas.
2. Determination of the on-site 100-year peak storm flows based upon the existing and proposed conditions utilizing the Civil Design Software, Rational Tabling program for Riverside County.
3. Preparation of hydrology maps.
4. Preparation of the drainage report.

II. PROJECT DESCRIPTION

The proposed project is located in the City of Moreno Valley, County of Riverside, California. The site is located along the east side of Old 215 Frontage Road and the west side of Edgemont Street between Cottonwood Avenue to the north, and Bay Avenue, to the south. The project site is made up of eight parcels, which are: APN 263-190-012, 014-019 & 036. The site is bounded by single family residences, a four-plex, and vacant land to the north, Edgemont Street to the east, a vacated cannabis collective and vacant land to the south, and Old 215 Frontage Road to the west. The existing boundary area is approximately 6.88 acres in size. The project proposes to join the existing eight parcels and make two separate large parcels. Each parcel is proposed to be developed with a 49,815 square foot industrial warehouse building with associated parking, hardscape, landscape, and access. Proposed street vacations from Old 215 will bring the total net project area to approximately 7.06 acres.

III. DRAINAGE AREA OVERVIEW

Existing Condition

The project site is currently vacant and undeveloped. Topographically, site elevations range from approximately 1540.00 feet to 1526.00 feet above Mean Sea Level (MSL). The project site generally drains from the south to the north to Edgemont Channel at an approximate grade of 1.20%. A small area from the neighboring single family residences to the north is tributary to the project site. These flows will be honored, but will be left out of the pre and post development analysis.

**PRELIMINARY DRAINAGE ANALYSIS
OLD 215 INDUSTRIAL BUILDING (PEN21-0325 / LST22-0007)
CITY OF MORENO VALLEY, CA**

Proposed Condition

Upon development, the site will be separated into three drainage areas and confluence at one central location. Area A1 will convey flows on the northerly portion of the site from west to east via sheet flow, ribbon gutter, and curb and gutter to a proposed drop inlet located on the east end of the site. Area A2 will convey flows from the central portion of the site west to east via sheet flow and ribbon gutter to the proposed drop inlet on the east side of the site. Area A3 will convey flows generated by the southerly portion of the site west to east via sheet flow, curb and gutter, and ribbon gutter to the proposed drop inlet. Flows captured by the drop inlet will be directed to a proposed underground detention basin via storm drain. Flows from the basin will be directed to a proposed sump and pump via storm drain. The sump and pump will pump flows to a proposed modular wetland unit sized for water quality purposes at a rate optimal for the modular wetland unit. Treated flows will leave the modular wetland unit via storm drain and enter a public storm drain line running through the project site. The public storm drain line is proposed as part of this project. In the event the underground basin reaches capacity, flows will overflow directly to the public storm drain line from the proposed drop inlet.

Off-Site

Flows generated by Edgemont Street adjacent to the project site historically enter the subject site and are conveyed northwesterly to Edgemont Channel. Upon development, flows from the street will enter a series of proposed under sidewalk drains that will direct flows to a proposed bioswale for water quality purposes. Treated flows will enter an underdrain, which will direct flows to a proposed catch basin located at the existing low point of Edgemont Street. The catch basin will direct flows west through the site, then north to Edgemont Channel. See Appendix E for preliminary hydrology calcs including normal depth calcs for the proposed storm drain. See Area B2 on Exhibit "C" for off-site hydrology map, which shows the area analyzed for these preliminary calculations. As seen in Appendix E.2, the peak flow rate entering the catch basin on Edgemont will be approximately 15.82 cfs. As seen in Appendix E.3, the preliminary design of the storm drain will handle these flows.

Flows generated by Old 215 adjacent to the project site historically run along project frontage before entering Edgemont Channel to the north. Upon development, flows will enter a series of under sidewalk drains, directing them to a proposed bioswale for water quality purposes. Treated flows will enter an underdrain, which will direct flows to a proposed catch basin located at the north end of the site. Flows from the proposed catch basin will be directed northwest toward Edgemont Channel where they will confluence with flows from Edgemont Street. The existing storm drain along the frontage that extends northerly from the existing headwall located at the southwest corner of the site will be removed, and a proposed drop inlet will replace the headwall. Flows will be directed northerly to the proposed catch basin via storm drain proposed as part of this project. The proposed raised center median will impede flows conveyed by the swale in the existing center median. A proposed drop inlet located at the south end of the proposed raised median will capture flows and confluence with flows captured at the southwest corner of the site.

**PRELIMINARY DRAINAGE ANALYSIS
OLD 215 INDUSTRIAL BUILDING (PEN21-0325 / LST22-0007)
CITY OF MORENO VALLEY, CA**

See Appendix E for preliminary hydrology calcs including normal depth calcs for the proposed storm drain. See Area B1 on Exhibit “C” for off-site hydrology map, which shows the area analyzed for these preliminary calculations. As seen in Appendix E.1, the peak flow rate entering the catch basin on Edgemont will be approximately 29.11 cfs. As seen in Appendix E.3, the preliminary design of the storm drain will handle these flows.

IV. HYDROLOGY

The Riverside County Hydrology Manual (RCFC&WCD) was used to develop the hydrologic parameters for the hydrology analysis. In addition, Hydrologic Soil Groups (HSG) were determined using the Natural Resources Conservation Service Web Soil Survey. The entire study area consists of soil type “C” (see Appendix E).

The Rational Method was used to determine the peak flow rates and times of concentration under the existing and proposed conditions. Computations were performed using the RSBC computer program developed by Civil Cadd/Civil Design Engineering Software.

V. RESULTS

For preliminary sizing of the proposed underground detention basin, a unit hydrograph analysis was performed for the 10-year, 24-hour storm event for both the existing condition and proposed condition. Calculations can be found in Appendix C and Appendix D. The results of the analysis are found below in Table 5-1. The difference in runoff volume for the existing and proposed condition is 0.73 acre-feet, which is approximately 32,000 cubic feet. The 100-year storm for the proposed condition has a peak flow rate of 4.22cfs compared to the existing condition of 3.95 cfs. The increase is minimal.

Unit Hydrograph			
Condition	Drainage Area (acre)	Q₁₀ (cfs)	V₁₀ (ac-ft)
Existing	7.06	2.04	0.75
Proposed	7.06	2.59	1.48

Table 5-1: Existing & Proposed Condition Unit Hydrograph Method Hydrology Results

VI. STUDY FINDINGS

The proposed basin will help reduce runoff volume during large storms and also help mitigate for increased peak flow rate caused by the development. Post-development flows will enter the underground basin via drop inlet, then get directed to a proposed sump and pump. The pump will direct flows to the proposed modular wetland system for water quality purposes at a rate optimal for treatment.

**PRELIMINARY DRAINAGE ANALYSIS
OLD 215 INDUSTRIAL BUILDING (PEN21-0325 / LST22-0007)
CITY OF MORENO VALLEY, CA**

VII. CONCLUSION

The proposed underground basin has been sized to retain the difference in volume between the existing condition and the proposed condition for the 10-year, 24-hour storm event. The basin will help reduce flood volume leaving the site and help mitigate post-development peak flow rate. In the event the basin reaches capacity, an overflow pipe will direct flows to the public storm drain line proposed as part of this project. Flows captured onsite will be directed to the proposed modular wetlands system for water quality purposes and discharge into the public storm drain line proposed as part of this project. Off site flows will be conveyed to Edgemont Channel as they are historically.

VIII. REFERENCES

1. Riverside County; *Riverside County Flood Control & Water Conservation District Hydrology Manual*, April 1978.
2. National Resources Conservation Service; Web Soil Survey. September 29, 2021.
3. NOAA's National Weather Service; NOAA Atlas 14, Volume 6, Version 2. November 10, 2021

**PRELIMINARY DRAINAGE ANALYSIS
OLD 215 INDUSTRIAL BUILDING (PEN21-0325 / LST22-0007)
CITY OF MORENO VALLEY, CA**

FIGURE 1: REGIONAL VICINITY MAP

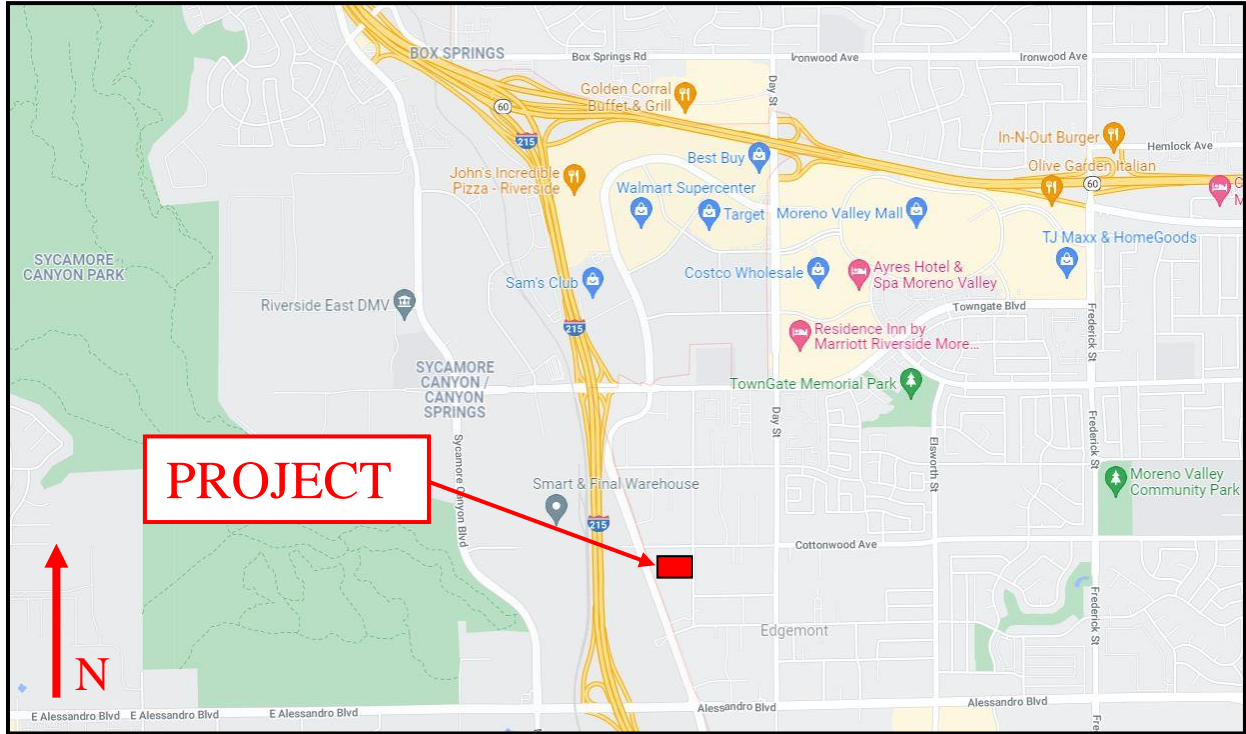

**PRELIMINARY DRAINAGE ANALYSIS
OLD 215 INDUSTRIAL BUILDING (PEN21-0325 / LST22-0007)
CITY OF MORENO VALLEY, CA**

FIGURE 2: LOCAL VICINITY MAP



FIGURE 3: FEMA FLOODPLAIN MAP

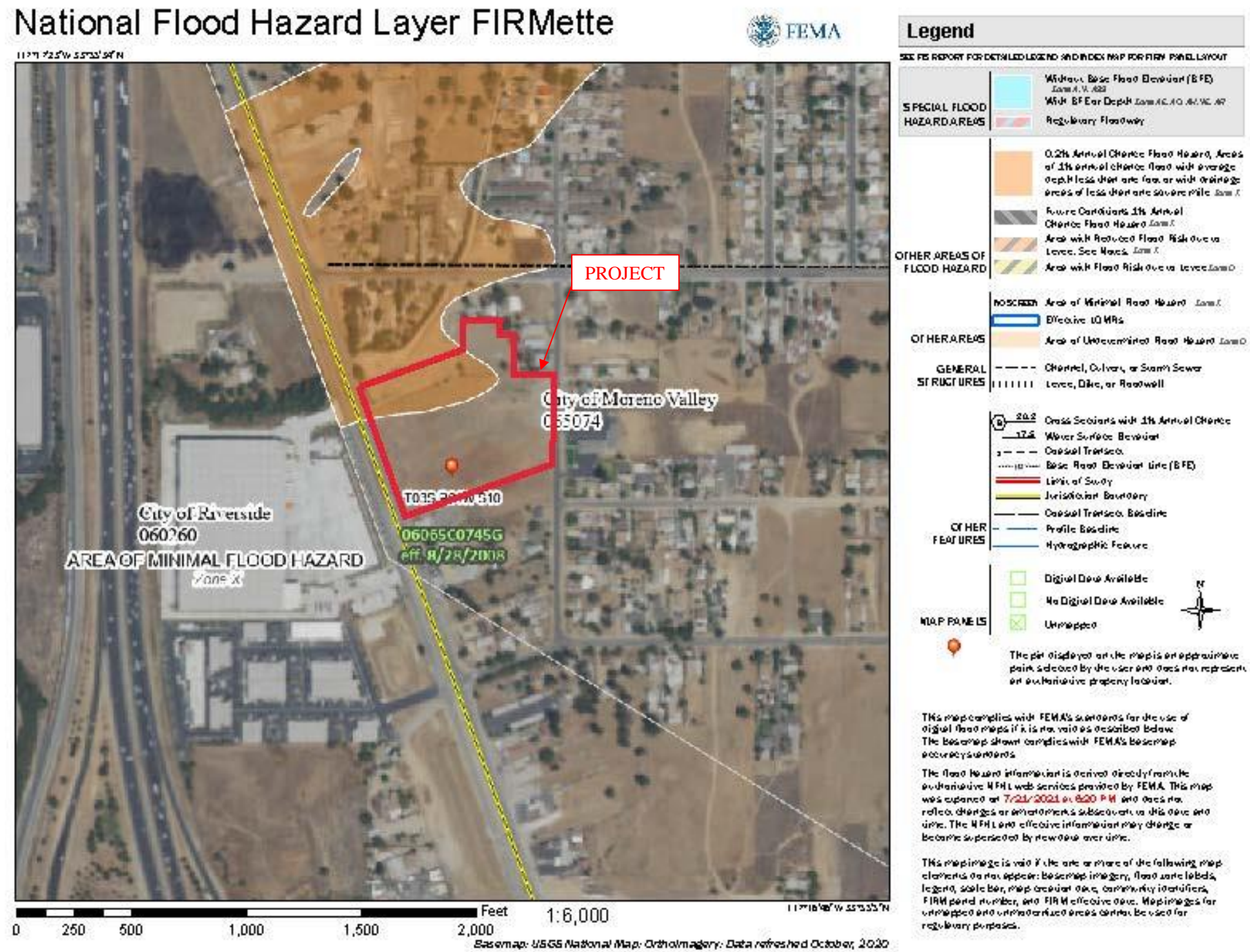

**PRELIMINARY DRAINAGE ANALYSIS
OLD 215 INDUSTRIAL BUILDING (PEN21-0325 / LST22-0007)
CITY OF MORENO VALLEY, CA**

APPENDIX A

**ON-SITE HYDROLOGY BASED ON EXISTING CONDITION
(RATIONAL METHOD)**

**PRELIMINARY DRAINAGE ANALYSIS
OLD 215 INDUSTRIAL BUILDING (PEN21-0325 / LST22-0007)
CITY OF MORENO VALLEY, CA**

APPENDIX A.1

10-YEAR HYDROLOGY CALCULATIONS (EXISTING)

Riverside County Rational Hydrology Program

CIVILCADD/CIVILDESIGN Engineering Software, (c) 1989 - 2018 Version 9.0
Rational Hydrology Study Date: 03/16/22 File:pre10.out

1494-0006 INDUSTRIAL WAREHOUSE
PRE-DEVELOPMENT ANALYSIS
10-YEAR STORM EVENT

***** Hydrology Study Control Information *****

English (in-lb) Units used in input data file

Program License Serial Number 6522

Rational Method Hydrology Program based on
Riverside County Flood Control & Water Conservation District
1978 hydrology manual

Storm event (year) = 10.00 Antecedent Moisture Condition = 2

Standard intensity-duration curves data (Plate D-4.1)
For the [Sunnymead-Moreno] area used.
10 year storm 10 minute intensity = 2.010 (In/Hr)
10 year storm 60 minute intensity = 0.820 (In/Hr)
100 year storm 10 minute intensity = 2.940 (In/Hr)
100 year storm 60 minute intensity = 1.200 (In/Hr)

Storm event year = 10.0
Calculated rainfall intensity data:
1 hour intensity = 0.820 (In/Hr)
Slope of intensity duration curve = 0.5000

+++++
Process from Point/Station 100.000 to Point/Station 101.000
**** INITIAL AREA EVALUATION ****

Initial area flow distance = 895.000 (Ft.)
Top (of initial area) elevation = 40.000 (Ft.)
Bottom (of initial area) elevation = 27.500 (Ft.)
Difference in elevation = 12.500 (Ft.)
Slope = 0.01397 s(percent)= 1.40
TC = k(0.530)*[(length^3)/(elevation change)]^0.2
Initial area time of concentration = 18.879 min.

Rainfall intensity = 1.462(In/Hr) for a 10.0 year storm
UNDEVELOPED (poor cover) subarea
Runoff Coefficient = 0.784
Decimal fraction soil group A = 0.000
Decimal fraction soil group B = 0.000
Decimal fraction soil group C = 1.000
Decimal fraction soil group D = 0.000
RI index for soil(AMC 2) = 86.00
Pervious area fraction = 1.000; Impervious fraction = 0.000
Initial subarea runoff = 8.088(CFS)
Total initial stream area = 7.060(Ac.)
Pervious area fraction = 1.000
End of computations, total study area = 7.06 (Ac.)
The following figures may
be used for a unit hydrograph study of the same area.

Area averaged pervious area fraction(Ap) = 1.000
Area averaged RI index number = 86.0

**PRELIMINARY DRAINAGE ANALYSIS
OLD 215 INDUSTRIAL BUILDING (PEN21-0325 / LST22-0007)
CITY OF MORENO VALLEY, CA**

APPENDIX A.2

100-YEAR HYDROLOGY CALCULATIONS (EXISTING)

Riverside County Rational Hydrology Program

CIVILCADD/CIVILDESIGN Engineering Software, (c) 1989 - 2018 Version 9.0
Rational Hydrology Study Date: 03/16/22 File:pre100.out

1494-0006 INDUSTRIAL WAREHOUSE
PRE-DEVELOPMENT ANALYSIS
100-YEAR STORM EVENT

***** Hydrology Study Control Information *****

English (in-lb) Units used in input data file

Program License Serial Number 6522

Rational Method Hydrology Program based on
Riverside County Flood Control & Water Conservation District
1978 hydrology manual

Storm event (year) = 100.00 Antecedent Moisture Condition = 3

Standard intensity-duration curves data (Plate D-4.1)
For the [Sunnymead-Moreno] area used.
10 year storm 10 minute intensity = 2.010 (In/Hr)
10 year storm 60 minute intensity = 0.820 (In/Hr)
100 year storm 10 minute intensity = 2.940 (In/Hr)
100 year storm 60 minute intensity = 1.200 (In/Hr)

Storm event year = 100.0
Calculated rainfall intensity data:
1 hour intensity = 1.200 (In/Hr)
Slope of intensity duration curve = 0.5000

+++++
Process from Point/Station 100.000 to Point/Station 101.000
**** INITIAL AREA EVALUATION ****

Initial area flow distance = 895.000 (Ft.)
Top (of initial area) elevation = 40.000 (Ft.)
Bottom (of initial area) elevation = 27.500 (Ft.)
Difference in elevation = 12.500 (Ft.)
Slope = 0.01397 s(percent)= 1.40
TC = k(0.530)*[(length^3)/(elevation change)]^0.2
Initial area time of concentration = 18.879 min.

Rainfall intensity = 2.139(In/Hr) for a 100.0 year storm
UNDEVELOPED (poor cover) subarea
Runoff Coefficient = 0.868
Decimal fraction soil group A = 0.000
Decimal fraction soil group B = 0.000
Decimal fraction soil group C = 1.000
Decimal fraction soil group D = 0.000
RI index for soil(AMC 3) = 94.40
Pervious area fraction = 1.000; Impervious fraction = 0.000
Initial subarea runoff = 13.108(CFS)
Total initial stream area = 7.060(Ac.)
Pervious area fraction = 1.000
End of computations, total study area = 7.06 (Ac.)
The following figures may
be used for a unit hydrograph study of the same area.

Area averaged pervious area fraction(Ap) = 1.000
Area averaged RI index number = 86.0

**PRELIMINARY DRAINAGE ANALYSIS
OLD 215 INDUSTRIAL BUILDING (PEN21-0325 / LST22-0007)
CITY OF MORENO VALLEY, CA**

APPENDIX B

**ON-SITE HYDROLOGY BASED ON PROPOSED CONDITION
(RATIONAL METHOD)**

**PRELIMINARY DRAINAGE ANALYSIS
OLD 215 INDUSTRIAL BUILDING (PEN21-0325 / LST22-0007)
CITY OF MORENO VALLEY, CA**

APPENDIX B.1

10-YEAR HYDROLOGY CALCULATIONS (PROPOSED)

Riverside County Rational Hydrology Program

CIVILCADD/CIVILDESIGN Engineering Software, (c) 1989 - 2018 Version 9.0
Rational Hydrology Study Date: 03/16/22 File:post10.out

1494-0006 INDUSTRIAL WAREHOUSE
POST-DEVELOPMENT
10-YEAR STORM EVENT

***** Hydrology Study Control Information *****

English (in-lb) Units used in input data file

Program License Serial Number 6522

Rational Method Hydrology Program based on
Riverside County Flood Control & Water Conservation District
1978 hydrology manual

Storm event (year) = 10.00 Antecedent Moisture Condition = 2

Standard intensity-duration curves data (Plate D-4.1)
For the [Sunnymead-Moreno] area used.
10 year storm 10 minute intensity = 2.010 (In/Hr)
10 year storm 60 minute intensity = 0.820 (In/Hr)
100 year storm 10 minute intensity = 2.940 (In/Hr)
100 year storm 60 minute intensity = 1.200 (In/Hr)

Storm event year = 10.0
Calculated rainfall intensity data:
1 hour intensity = 0.820 (In/Hr)
Slope of intensity duration curve = 0.5000

+++++
Process from Point/Station 100.000 to Point/Station 101.000
**** INITIAL AREA EVALUATION ****

Initial area flow distance = 667.000 (Ft.)
Top (of initial area) elevation = 36.500 (Ft.)
Bottom (of initial area) elevation = 32.050 (Ft.)
Difference in elevation = 4.450 (Ft.)
Slope = 0.00667 s(percent) = 0.67
TC = $k(0.300) * [(length^3) / (elevation\ change)]^{0.2}$
Initial area time of concentration = 11.013 min.

Rainfall intensity = 1.914(In/Hr) for a 10.0 year storm
COMMERCIAL subarea type
Runoff Coefficient = 0.879
Decimal fraction soil group A = 0.000
Decimal fraction soil group B = 0.000
Decimal fraction soil group C = 1.000
Decimal fraction soil group D = 0.000
RI index for soil(AMC 2) = 69.00
Pervious area fraction = 0.100; Impervious fraction = 0.900
Initial subarea runoff = 3.228(CFS)
Total initial stream area = 1.920(Ac.)
Pervious area fraction = 0.100

++++
Process from Point/Station 101.000 to Point/Station 101.000
**** CONFLUENCE OF MAIN STREAMS ****

The following data inside Main Stream is listed:

In Main Stream number: 1
Stream flow area = 1.920(Ac.)
Runoff from this stream = 3.228(CFS)
Time of concentration = 11.01 min.
Rainfall intensity = 1.914(In/Hr)
Program is now starting with Main Stream No. 2

++++
Process from Point/Station 102.000 to Point/Station 101.000
**** INITIAL AREA EVALUATION ****

Initial area flow distance = 557.000(Ft.)
Top (of initial area) elevation = 37.200(Ft.)
Bottom (of initial area) elevation = 32.050(Ft.)
Difference in elevation = 5.150(Ft.)
Slope = 0.00925 s(percent)= 0.92
TC = k(0.300)*[(length^3)/(elevation change)]^0.2
Initial area time of concentration = 9.600 min.
Rainfall intensity = 2.050(In/Hr) for a 10.0 year storm
COMMERCIAL subarea type
Runoff Coefficient = 0.880
Decimal fraction soil group A = 0.000
Decimal fraction soil group B = 0.000
Decimal fraction soil group C = 1.000
Decimal fraction soil group D = 0.000
RI index for soil(AMC 2) = 69.00
Pervious area fraction = 0.100; Impervious fraction = 0.900
Initial subarea runoff = 5.157(CFS)
Total initial stream area = 2.860(Ac.)
Pervious area fraction = 0.100

++++
Process from Point/Station 101.000 to Point/Station 101.000

**** CONFLUENCE OF MAIN STREAMS ****

The following data inside Main Stream is listed:

In Main Stream number: 2
Stream flow area = 2.860 (Ac.)
Runoff from this stream = 5.157 (CFS)
Time of concentration = 9.60 min.
Rainfall intensity = 2.050 (In/Hr)
Program is now starting with Main Stream No. 3

+++++
Process from Point/Station 103.000 to Point/Station 101.000
**** INITIAL AREA EVALUATION ****

Initial area flow distance = 715.000 (Ft.)
Top (of initial area) elevation = 37.200 (Ft.)
Bottom (of initial area) elevation = 32.050 (Ft.)
Difference in elevation = 5.150 (Ft.)
Slope = 0.00720 s(percent) = 0.72
TC = $k(0.300) * [(length^3) / (elevation\ change)]^{0.2}$
Initial area time of concentration = 11.152 min.
Rainfall intensity = 1.902 (In/Hr) for a 10.0 year storm
COMMERCIAL subarea type
Runoff Coefficient = 0.878
Decimal fraction soil group A = 0.000
Decimal fraction soil group B = 0.000
Decimal fraction soil group C = 1.000
Decimal fraction soil group D = 0.000
RI index for soil (AMC 2) = 69.00
Pervious area fraction = 0.100; Impervious fraction = 0.900
Initial subarea runoff = 3.809 (CFS)
Total initial stream area = 2.280 (Ac.)
Pervious area fraction = 0.100

+++++
Process from Point/Station 101.000 to Point/Station 101.000
**** CONFLUENCE OF MAIN STREAMS ****

The following data inside Main Stream is listed:

In Main Stream number: 3
Stream flow area = 2.280 (Ac.)
Runoff from this stream = 3.809 (CFS)
Time of concentration = 11.15 min.
Rainfall intensity = 1.902 (In/Hr)
Summary of stream data:

Stream No.	Flow rate (CFS)	TC (min)	Rainfall Intensity (In/Hr)
1	3.228	11.01	1.914
2	5.157	9.60	2.050

3 3.809 11.15 1.902
 Largest stream flow has longer or shorter time of concentration
 $Q_p = 5.157 + \text{sum of}$
 Q_a T_b/T_a
 3.228 * 0.872 = 2.814
 Q_a T_b/T_a
 3.809 * 0.861 = 3.279
 $Q_p = 11.251$

Total of 3 main streams to confluence:
 Flow rates before confluence point:
 3.228 5.157 3.809
 Area of streams before confluence:
 1.920 2.860 2.280

Results of confluence:
 Total flow rate = 11.251 (CFS)
 Time of concentration = 9.600 min.
 Effective stream area after confluence = 7.060 (Ac.)
 End of computations, total study area = 7.06 (Ac.)
 The following figures may
 be used for a unit hydrograph study of the same area.

Area averaged pervious area fraction (A_p) = 0.100
 Area averaged RI index number = 69.0

**PRELIMINARY DRAINAGE ANALYSIS
OLD 215 INDUSTRIAL BUILDING (PEN21-0325 / LST22-0007)
CITY OF MORENO VALLEY, CA**

APPENDIX B.2

100-YEAR HYDROLOGY CALCULATIONS (PROPOSED)

Riverside County Rational Hydrology Program

CIVILCADD/CIVILDESIGN Engineering Software, (c) 1989 - 2018 Version 9.0
Rational Hydrology Study Date: 03/16/22 File:post100.out

1494-0006 INDUSTRIAL WAREHOUSE
POST-DEVELOPMENT
100-YEAR STORM EVENT

***** Hydrology Study Control Information *****

English (in-lb) Units used in input data file

Program License Serial Number 6522

Rational Method Hydrology Program based on
Riverside County Flood Control & Water Conservation District
1978 hydrology manual

Storm event (year) = 100.00 Antecedent Moisture Condition = 3

Standard intensity-duration curves data (Plate D-4.1)
For the [Sunnymead-Moreno] area used.
10 year storm 10 minute intensity = 2.010 (In/Hr)
10 year storm 60 minute intensity = 0.820 (In/Hr)
100 year storm 10 minute intensity = 2.940 (In/Hr)
100 year storm 60 minute intensity = 1.200 (In/Hr)

Storm event year = 100.0
Calculated rainfall intensity data:
1 hour intensity = 1.200 (In/Hr)
Slope of intensity duration curve = 0.5000

+++++
Process from Point/Station 100.000 to Point/Station 101.000
**** INITIAL AREA EVALUATION ****

Initial area flow distance = 667.000 (Ft.)
Top (of initial area) elevation = 36.500 (Ft.)
Bottom (of initial area) elevation = 32.050 (Ft.)
Difference in elevation = 4.450 (Ft.)
Slope = 0.00667 s(percent) = 0.67
TC = k(0.300)*[(length^3)/(elevation change)]^0.2
Initial area time of concentration = 11.013 min.

Rainfall intensity = 2.801(In/Hr) for a 100.0 year storm
COMMERCIAL subarea type
Runoff Coefficient = 0.893
Decimal fraction soil group A = 0.000
Decimal fraction soil group B = 0.000
Decimal fraction soil group C = 1.000
Decimal fraction soil group D = 0.000
RI index for soil(AMC 3) = 84.40
Pervious area fraction = 0.100; Impervious fraction = 0.900
Initial subarea runoff = 4.801(CFS)
Total initial stream area = 1.920(Ac.)
Pervious area fraction = 0.100

++++
Process from Point/Station 101.000 to Point/Station 101.000
**** CONFLUENCE OF MAIN STREAMS ****

The following data inside Main Stream is listed:

In Main Stream number: 1
Stream flow area = 1.920(Ac.)
Runoff from this stream = 4.801(CFS)
Time of concentration = 11.01 min.
Rainfall intensity = 2.801(In/Hr)
Program is now starting with Main Stream No. 2

++++
Process from Point/Station 102.000 to Point/Station 101.000
**** INITIAL AREA EVALUATION ****

Initial area flow distance = 557.000(Ft.)
Top (of initial area) elevation = 37.200(Ft.)
Bottom (of initial area) elevation = 32.050(Ft.)
Difference in elevation = 5.150(Ft.)
Slope = 0.00925 s(percent)= 0.92
TC = k(0.300)*[(length^3)/(elevation change)]^0.2
Initial area time of concentration = 9.600 min.
Rainfall intensity = 3.000(In/Hr) for a 100.0 year storm
COMMERCIAL subarea type
Runoff Coefficient = 0.893
Decimal fraction soil group A = 0.000
Decimal fraction soil group B = 0.000
Decimal fraction soil group C = 1.000
Decimal fraction soil group D = 0.000
RI index for soil(AMC 3) = 84.40
Pervious area fraction = 0.100; Impervious fraction = 0.900
Initial subarea runoff = 7.663(CFS)
Total initial stream area = 2.860(Ac.)
Pervious area fraction = 0.100

++++
Process from Point/Station 101.000 to Point/Station 101.000

**** CONFLUENCE OF MAIN STREAMS ****

The following data inside Main Stream is listed:

In Main Stream number: 2
Stream flow area = 2.860 (Ac.)
Runoff from this stream = 7.663 (CFS)
Time of concentration = 9.60 min.
Rainfall intensity = 3.000 (In/Hr)
Program is now starting with Main Stream No. 3

+++++
Process from Point/Station 103.000 to Point/Station 101.000
**** INITIAL AREA EVALUATION ****

Initial area flow distance = 715.000 (Ft.)
Top (of initial area) elevation = 37.200 (Ft.)
Bottom (of initial area) elevation = 32.050 (Ft.)
Difference in elevation = 5.150 (Ft.)
Slope = 0.00720 s(percent) = 0.72
TC = $k(0.300) * [(length^3) / (elevation\ change)]^{0.2}$
Initial area time of concentration = 11.152 min.
Rainfall intensity = 2.783 (In/Hr) for a 100.0 year storm
COMMERCIAL subarea type
Runoff Coefficient = 0.893
Decimal fraction soil group A = 0.000
Decimal fraction soil group B = 0.000
Decimal fraction soil group C = 1.000
Decimal fraction soil group D = 0.000
RI index for soil (AMC 3) = 84.40
Pervious area fraction = 0.100; Impervious fraction = 0.900
Initial subarea runoff = 5.665 (CFS)
Total initial stream area = 2.280 (Ac.)
Pervious area fraction = 0.100

+++++
Process from Point/Station 101.000 to Point/Station 101.000
**** CONFLUENCE OF MAIN STREAMS ****

The following data inside Main Stream is listed:

In Main Stream number: 3
Stream flow area = 2.280 (Ac.)
Runoff from this stream = 5.665 (CFS)
Time of concentration = 11.15 min.
Rainfall intensity = 2.783 (In/Hr)
Summary of stream data:

Stream No.	Flow rate (CFS)	TC (min)	Rainfall Intensity (In/Hr)
1	4.801	11.01	2.801
2	7.663	9.60	3.000

3 5.665 11.15 2.783
 Largest stream flow has longer or shorter time of concentration
 $Q_p = 7.663 + \text{sum of}$
 $Q_a \quad T_b/T_a$
 4.801 * 0.872 = 4.185
 $Q_a \quad T_b/T_a$
 5.665 * 0.861 = 4.877
 $Q_p = 16.725$

Total of 3 main streams to confluence:
 Flow rates before confluence point:
 4.801 7.663 5.665
 Area of streams before confluence:
 1.920 2.860 2.280

Results of confluence:
 Total flow rate = 16.725 (CFS)
 Time of concentration = 9.600 min.
 Effective stream area after confluence = 7.060 (Ac.)
 End of computations, total study area = 7.06 (Ac.)
 The following figures may
 be used for a unit hydrograph study of the same area.

Area averaged pervious area fraction (A_p) = 0.100
 Area averaged RI index number = 69.0

**PRELIMINARY DRAINAGE ANALYSIS
OLD 215 INDUSTRIAL BUILDING (PEN21-0325 / LST22-0007)
CITY OF MORENO VALLEY, CA**

APPENDIX C

**ON-SITE HYDROLOGY BASED ON EXISTING CONDITION (UNIT
HYDROGRAPH)**

**PRELIMINARY DRAINAGE ANALYSIS
OLD 215 INDUSTRIAL BUILDING (PEN21-0325 / LST22-0007)
CITY OF MORENO VALLEY, CA**

APPENDIX C.1

10-YEAR HYDROLOGY CALCULATIONS (EXISTING)

Unit Hydrograph Analysis

Copyright (c) CIVILCADD/CIVILDESIGN, 1989 - 2018, Version 9.0
Study date 03/16/22 File: 102410.out

+++++

Riverside County Synthetic Unit Hydrology Method
RCFC & WCD Manual date - April 1978

Program License Serial Number 6522

English (in-lb) Input Units Used
English Rainfall Data (Inches) Input Values Used

English Units used in output format

1494-0006 OLD 215 FRONTAGE ROAD
EXISTING CONDITION
10-YEAR, 24-HOUR STORM EVENT

Drainage Area = 7.06(Ac.) = 0.011 Sq. Mi.
Drainage Area for Depth-Area Areal Adjustment = 7.06(Ac.) = 0.011
Sq. Mi.

USER Entry of lag time in hours
Lag time = 0.189 Hr.
Lag time = 11.33 Min.
25% of lag time = 2.83 Min.
40% of lag time = 4.53 Min.
Unit time = 5.00 Min.
Duration of storm = 24 Hour(s)
User Entered Base Flow = 0.00 (CFS)

2 YEAR Area rainfall data:

Area(Ac.) [1]	Rainfall(In) [2]	Weighting[1*2]
7.06	1.85	13.06

100 YEAR Area rainfall data:

Area(Ac.) [1]	Rainfall(In) [2]	Weighting[1*2]
7.06	4.52	31.91

STORM EVENT (YEAR) = 10.00
Area Averaged 2-Year Rainfall = 1.850 (In)
Area Averaged 100-Year Rainfall = 4.520 (In)

Point rain (area averaged) = 2.948 (In)
Areal adjustment factor = 100.00 %

Adjusted average point rain = 2.948(In)

Sub-Area Data:

Area(Ac.) Runoff Index Impervious %
7.060 91.00 0.000
Total Area Entered = 7.06(Ac.)

RI	RI	Infil. Rate	Impervious	Adj. Infil. Rate	Area%	F
AMC2	AMC-2	(In/Hr)	(Dec.%)	(In/Hr)	(Dec.)	(In/Hr)
91.0	91.0	0.117	0.000	0.117	1.000	0.117
						Sum (F) = 0.117

Area averaged mean soil loss (F) (In/Hr) = 0.117
Minimum soil loss rate ((In/Hr)) = 0.059
(for 24 hour storm duration)
Soil low loss rate (decimal) = 0.900

Unit Hydrograph
VALLEY S-Curve

Unit Hydrograph Data

Unit time period (hrs)	Time % of lag	Distribution Graph %	Unit Hydrograph (CFS)
1	0.083	44.138	5.059
2	0.167	88.277	21.222
3	0.250	132.415	28.410
4	0.333	176.554	15.425
5	0.417	220.692	7.544
6	0.500	264.831	5.082
7	0.583	308.969	3.785
8	0.667	353.107	2.833
9	0.750	397.246	2.247
10	0.833	441.384	1.709
11	0.917	485.523	1.385
12	1.000	529.661	1.246
13	1.083	573.799	0.964
14	1.167	617.938	0.799
15	1.250	662.076	0.642
16	1.333	706.215	0.488
17	1.417	750.353	0.441
18	1.500	794.492	0.441
19	1.583	838.630	0.276
Sum = 100.000			Sum= 7.115

The following loss rate calculations reflect use of the minimum calculated loss rate subtracted from the Storm Rain to produce the maximum Effective Rain value

Unit Time (Hr.)	Pattern Percent	Storm Rain (In/Hr)	Loss rate(In./Hr)		Effective (In/Hr)
			Max	Low	
1	0.08	0.024	(0.207)	0.021	0.002
2	0.17	0.024	(0.207)	0.021	0.002
3	0.25	0.024	(0.206)	0.021	0.002
4	0.33	0.035	(0.205)	0.032	0.004
5	0.42	0.035	(0.204)	0.032	0.004
6	0.50	0.035	(0.203)	0.032	0.004

7	0.58	0.10	0.035	(0.203)	0.032	0.004
8	0.67	0.10	0.035	(0.202)	0.032	0.004
9	0.75	0.10	0.035	(0.201)	0.032	0.004
10	0.83	0.13	0.047	(0.200)	0.042	0.005
11	0.92	0.13	0.047	(0.199)	0.042	0.005
12	1.00	0.13	0.047	(0.199)	0.042	0.005
13	1.08	0.10	0.035	(0.198)	0.032	0.004
14	1.17	0.10	0.035	(0.197)	0.032	0.004
15	1.25	0.10	0.035	(0.196)	0.032	0.004
16	1.33	0.10	0.035	(0.196)	0.032	0.004
17	1.42	0.10	0.035	(0.195)	0.032	0.004
18	1.50	0.10	0.035	(0.194)	0.032	0.004
19	1.58	0.10	0.035	(0.193)	0.032	0.004
20	1.67	0.10	0.035	(0.192)	0.032	0.004
21	1.75	0.10	0.035	(0.192)	0.032	0.004
22	1.83	0.13	0.047	(0.191)	0.042	0.005
23	1.92	0.13	0.047	(0.190)	0.042	0.005
24	2.00	0.13	0.047	(0.189)	0.042	0.005
25	2.08	0.13	0.047	(0.189)	0.042	0.005
26	2.17	0.13	0.047	(0.188)	0.042	0.005
27	2.25	0.13	0.047	(0.187)	0.042	0.005
28	2.33	0.13	0.047	(0.186)	0.042	0.005
29	2.42	0.13	0.047	(0.186)	0.042	0.005
30	2.50	0.13	0.047	(0.185)	0.042	0.005
31	2.58	0.17	0.059	(0.184)	0.053	0.006
32	2.67	0.17	0.059	(0.183)	0.053	0.006
33	2.75	0.17	0.059	(0.183)	0.053	0.006
34	2.83	0.17	0.059	(0.182)	0.053	0.006
35	2.92	0.17	0.059	(0.181)	0.053	0.006
36	3.00	0.17	0.059	(0.180)	0.053	0.006
37	3.08	0.17	0.059	(0.180)	0.053	0.006
38	3.17	0.17	0.059	(0.179)	0.053	0.006
39	3.25	0.17	0.059	(0.178)	0.053	0.006
40	3.33	0.17	0.059	(0.177)	0.053	0.006
41	3.42	0.17	0.059	(0.177)	0.053	0.006
42	3.50	0.17	0.059	(0.176)	0.053	0.006
43	3.58	0.17	0.059	(0.175)	0.053	0.006
44	3.67	0.17	0.059	(0.174)	0.053	0.006
45	3.75	0.17	0.059	(0.174)	0.053	0.006
46	3.83	0.20	0.071	(0.173)	0.064	0.007
47	3.92	0.20	0.071	(0.172)	0.064	0.007
48	4.00	0.20	0.071	(0.171)	0.064	0.007
49	4.08	0.20	0.071	(0.171)	0.064	0.007
50	4.17	0.20	0.071	(0.170)	0.064	0.007
51	4.25	0.20	0.071	(0.169)	0.064	0.007
52	4.33	0.23	0.083	(0.169)	0.074	0.008
53	4.42	0.23	0.083	(0.168)	0.074	0.008
54	4.50	0.23	0.083	(0.167)	0.074	0.008
55	4.58	0.23	0.083	(0.166)	0.074	0.008
56	4.67	0.23	0.083	(0.166)	0.074	0.008
57	4.75	0.23	0.083	(0.165)	0.074	0.008
58	4.83	0.27	0.094	(0.164)	0.085	0.009
59	4.92	0.27	0.094	(0.164)	0.085	0.009
60	5.00	0.27	0.094	(0.163)	0.085	0.009
61	5.08	0.20	0.071	(0.162)	0.064	0.007
62	5.17	0.20	0.071	(0.161)	0.064	0.007
63	5.25	0.20	0.071	(0.161)	0.064	0.007
64	5.33	0.23	0.083	(0.160)	0.074	0.008
65	5.42	0.23	0.083	(0.159)	0.074	0.008
66	5.50	0.23	0.083	(0.159)	0.074	0.008

67	5.58	0.27	0.094	(0.158)	0.085	0.009
68	5.67	0.27	0.094	(0.157)	0.085	0.009
69	5.75	0.27	0.094	(0.157)	0.085	0.009
70	5.83	0.27	0.094	(0.156)	0.085	0.009
71	5.92	0.27	0.094	(0.155)	0.085	0.009
72	6.00	0.27	0.094	(0.154)	0.085	0.009
73	6.08	0.30	0.106	(0.154)	0.096	0.011
74	6.17	0.30	0.106	(0.153)	0.096	0.011
75	6.25	0.30	0.106	(0.152)	0.096	0.011
76	6.33	0.30	0.106	(0.152)	0.096	0.011
77	6.42	0.30	0.106	(0.151)	0.096	0.011
78	6.50	0.30	0.106	(0.150)	0.096	0.011
79	6.58	0.33	0.118	(0.150)	0.106	0.012
80	6.67	0.33	0.118	(0.149)	0.106	0.012
81	6.75	0.33	0.118	(0.148)	0.106	0.012
82	6.83	0.33	0.118	(0.148)	0.106	0.012
83	6.92	0.33	0.118	(0.147)	0.106	0.012
84	7.00	0.33	0.118	(0.146)	0.106	0.012
85	7.08	0.33	0.118	(0.146)	0.106	0.012
86	7.17	0.33	0.118	(0.145)	0.106	0.012
87	7.25	0.33	0.118	(0.144)	0.106	0.012
88	7.33	0.37	0.130	(0.144)	0.117	0.013
89	7.42	0.37	0.130	(0.143)	0.117	0.013
90	7.50	0.37	0.130	(0.142)	0.117	0.013
91	7.58	0.40	0.142	(0.142)	0.127	0.014
92	7.67	0.40	0.142	(0.141)	0.127	0.014
93	7.75	0.40	0.142	(0.140)	0.127	0.014
94	7.83	0.43	0.153	(0.140)	0.138	0.015
95	7.92	0.43	0.153	(0.139)	0.138	0.015
96	8.00	0.43	0.153	(0.138)	0.138	0.015
97	8.08	0.50	0.177	0.138	(0.159)	0.039
98	8.17	0.50	0.177	0.137	(0.159)	0.040
99	8.25	0.50	0.177	0.137	(0.159)	0.040
100	8.33	0.50	0.177	0.136	(0.159)	0.041
101	8.42	0.50	0.177	0.135	(0.159)	0.042
102	8.50	0.50	0.177	0.135	(0.159)	0.042
103	8.58	0.53	0.189	0.134	(0.170)	0.055
104	8.67	0.53	0.189	0.133	(0.170)	0.055
105	8.75	0.53	0.189	0.133	(0.170)	0.056
106	8.83	0.57	0.200	0.132	(0.180)	0.068
107	8.92	0.57	0.200	0.131	(0.180)	0.069
108	9.00	0.57	0.200	0.131	(0.180)	0.070
109	9.08	0.63	0.224	0.130	(0.202)	0.094
110	9.17	0.63	0.224	0.130	(0.202)	0.094
111	9.25	0.63	0.224	0.129	(0.202)	0.095
112	9.33	0.67	0.236	0.128	(0.212)	0.107
113	9.42	0.67	0.236	0.128	(0.212)	0.108
114	9.50	0.67	0.236	0.127	(0.212)	0.109
115	9.58	0.70	0.248	0.127	(0.223)	0.121
116	9.67	0.70	0.248	0.126	(0.223)	0.122
117	9.75	0.70	0.248	0.125	(0.223)	0.122
118	9.83	0.73	0.259	0.125	(0.234)	0.135
119	9.92	0.73	0.259	0.124	(0.234)	0.135
120	10.00	0.73	0.259	0.124	(0.234)	0.136
121	10.08	0.50	0.177	0.123	(0.159)	0.054
122	10.17	0.50	0.177	0.122	(0.159)	0.055
123	10.25	0.50	0.177	0.122	(0.159)	0.055
124	10.33	0.50	0.177	0.121	(0.159)	0.056
125	10.42	0.50	0.177	0.121	(0.159)	0.056
126	10.50	0.50	0.177	0.120	(0.159)	0.057

127	10.58	0.67	0.236	0.119	(0.212)	0.116
128	10.67	0.67	0.236	0.119	(0.212)	0.117
129	10.75	0.67	0.236	0.118	(0.212)	0.118
130	10.83	0.67	0.236	0.118	(0.212)	0.118
131	10.92	0.67	0.236	0.117	(0.212)	0.119
132	11.00	0.67	0.236	0.117	(0.212)	0.119
133	11.08	0.63	0.224	0.116	(0.202)	0.108
134	11.17	0.63	0.224	0.115	(0.202)	0.109
135	11.25	0.63	0.224	0.115	(0.202)	0.109
136	11.33	0.63	0.224	0.114	(0.202)	0.110
137	11.42	0.63	0.224	0.114	(0.202)	0.110
138	11.50	0.63	0.224	0.113	(0.202)	0.111
139	11.58	0.57	0.200	0.113	(0.180)	0.088
140	11.67	0.57	0.200	0.112	(0.180)	0.089
141	11.75	0.57	0.200	0.111	(0.180)	0.089
142	11.83	0.60	0.212	0.111	(0.191)	0.101
143	11.92	0.60	0.212	0.110	(0.191)	0.102
144	12.00	0.60	0.212	0.110	(0.191)	0.103
145	12.08	0.83	0.295	0.109	(0.265)	0.186
146	12.17	0.83	0.295	0.109	(0.265)	0.186
147	12.25	0.83	0.295	0.108	(0.265)	0.187
148	12.33	0.87	0.307	0.108	(0.276)	0.199
149	12.42	0.87	0.307	0.107	(0.276)	0.200
150	12.50	0.87	0.307	0.107	(0.276)	0.200
151	12.58	0.93	0.330	0.106	(0.297)	0.224
152	12.67	0.93	0.330	0.105	(0.297)	0.225
153	12.75	0.93	0.330	0.105	(0.297)	0.225
154	12.83	0.97	0.342	0.104	(0.308)	0.238
155	12.92	0.97	0.342	0.104	(0.308)	0.238
156	13.00	0.97	0.342	0.103	(0.308)	0.239
157	13.08	1.13	0.401	0.103	(0.361)	0.298
158	13.17	1.13	0.401	0.102	(0.361)	0.299
159	13.25	1.13	0.401	0.102	(0.361)	0.299
160	13.33	1.13	0.401	0.101	(0.361)	0.300
161	13.42	1.13	0.401	0.101	(0.361)	0.300
162	13.50	1.13	0.401	0.100	(0.361)	0.301
163	13.58	0.77	0.271	0.100	(0.244)	0.172
164	13.67	0.77	0.271	0.099	(0.244)	0.172
165	13.75	0.77	0.271	0.099	(0.244)	0.173
166	13.83	0.77	0.271	0.098	(0.244)	0.173
167	13.92	0.77	0.271	0.098	(0.244)	0.174
168	14.00	0.77	0.271	0.097	(0.244)	0.174
169	14.08	0.90	0.318	0.097	(0.287)	0.222
170	14.17	0.90	0.318	0.096	(0.287)	0.222
171	14.25	0.90	0.318	0.096	(0.287)	0.223
172	14.33	0.87	0.307	0.095	(0.276)	0.211
173	14.42	0.87	0.307	0.095	(0.276)	0.212
174	14.50	0.87	0.307	0.094	(0.276)	0.212
175	14.58	0.87	0.307	0.094	(0.276)	0.213
176	14.67	0.87	0.307	0.093	(0.276)	0.213
177	14.75	0.87	0.307	0.093	(0.276)	0.214
178	14.83	0.83	0.295	0.092	(0.265)	0.203
179	14.92	0.83	0.295	0.092	(0.265)	0.203
180	15.00	0.83	0.295	0.091	(0.265)	0.203
181	15.08	0.80	0.283	0.091	(0.255)	0.192
182	15.17	0.80	0.283	0.090	(0.255)	0.193
183	15.25	0.80	0.283	0.090	(0.255)	0.193
184	15.33	0.77	0.271	0.090	(0.244)	0.182
185	15.42	0.77	0.271	0.089	(0.244)	0.182
186	15.50	0.77	0.271	0.089	(0.244)	0.183

187	15.58	0.63	0.224	0.088	(0.202)	0.136
188	15.67	0.63	0.224	0.088	(0.202)	0.136
189	15.75	0.63	0.224	0.087	(0.202)	0.137
190	15.83	0.63	0.224	0.087	(0.202)	0.137
191	15.92	0.63	0.224	0.086	(0.202)	0.138
192	16.00	0.63	0.224	0.086	(0.202)	0.138
193	16.08	0.13	0.047	(0.085)	0.042	0.005
194	16.17	0.13	0.047	(0.085)	0.042	0.005
195	16.25	0.13	0.047	(0.085)	0.042	0.005
196	16.33	0.13	0.047	(0.084)	0.042	0.005
197	16.42	0.13	0.047	(0.084)	0.042	0.005
198	16.50	0.13	0.047	(0.083)	0.042	0.005
199	16.58	0.10	0.035	(0.083)	0.032	0.004
200	16.67	0.10	0.035	(0.082)	0.032	0.004
201	16.75	0.10	0.035	(0.082)	0.032	0.004
202	16.83	0.10	0.035	(0.082)	0.032	0.004
203	16.92	0.10	0.035	(0.081)	0.032	0.004
204	17.00	0.10	0.035	(0.081)	0.032	0.004
205	17.08	0.17	0.059	(0.080)	0.053	0.006
206	17.17	0.17	0.059	(0.080)	0.053	0.006
207	17.25	0.17	0.059	(0.080)	0.053	0.006
208	17.33	0.17	0.059	(0.079)	0.053	0.006
209	17.42	0.17	0.059	(0.079)	0.053	0.006
210	17.50	0.17	0.059	(0.078)	0.053	0.006
211	17.58	0.17	0.059	(0.078)	0.053	0.006
212	17.67	0.17	0.059	(0.078)	0.053	0.006
213	17.75	0.17	0.059	(0.077)	0.053	0.006
214	17.83	0.13	0.047	(0.077)	0.042	0.005
215	17.92	0.13	0.047	(0.076)	0.042	0.005
216	18.00	0.13	0.047	(0.076)	0.042	0.005
217	18.08	0.13	0.047	(0.076)	0.042	0.005
218	18.17	0.13	0.047	(0.075)	0.042	0.005
219	18.25	0.13	0.047	(0.075)	0.042	0.005
220	18.33	0.13	0.047	(0.075)	0.042	0.005
221	18.42	0.13	0.047	(0.074)	0.042	0.005
222	18.50	0.13	0.047	(0.074)	0.042	0.005
223	18.58	0.10	0.035	(0.074)	0.032	0.004
224	18.67	0.10	0.035	(0.073)	0.032	0.004
225	18.75	0.10	0.035	(0.073)	0.032	0.004
226	18.83	0.07	0.024	(0.072)	0.021	0.002
227	18.92	0.07	0.024	(0.072)	0.021	0.002
228	19.00	0.07	0.024	(0.072)	0.021	0.002
229	19.08	0.10	0.035	(0.071)	0.032	0.004
230	19.17	0.10	0.035	(0.071)	0.032	0.004
231	19.25	0.10	0.035	(0.071)	0.032	0.004
232	19.33	0.13	0.047	(0.070)	0.042	0.005
233	19.42	0.13	0.047	(0.070)	0.042	0.005
234	19.50	0.13	0.047	(0.070)	0.042	0.005
235	19.58	0.10	0.035	(0.069)	0.032	0.004
236	19.67	0.10	0.035	(0.069)	0.032	0.004
237	19.75	0.10	0.035	(0.069)	0.032	0.004
238	19.83	0.07	0.024	(0.069)	0.021	0.002
239	19.92	0.07	0.024	(0.068)	0.021	0.002
240	20.00	0.07	0.024	(0.068)	0.021	0.002
241	20.08	0.10	0.035	(0.068)	0.032	0.004
242	20.17	0.10	0.035	(0.067)	0.032	0.004
243	20.25	0.10	0.035	(0.067)	0.032	0.004
244	20.33	0.10	0.035	(0.067)	0.032	0.004
245	20.42	0.10	0.035	(0.066)	0.032	0.004
246	20.50	0.10	0.035	(0.066)	0.032	0.004

247	20.58	0.10	0.035	(0.066)	0.032	0.004
248	20.67	0.10	0.035	(0.066)	0.032	0.004
249	20.75	0.10	0.035	(0.065)	0.032	0.004
250	20.83	0.07	0.024	(0.065)	0.021	0.002
251	20.92	0.07	0.024	(0.065)	0.021	0.002
252	21.00	0.07	0.024	(0.065)	0.021	0.002
253	21.08	0.10	0.035	(0.064)	0.032	0.004
254	21.17	0.10	0.035	(0.064)	0.032	0.004
255	21.25	0.10	0.035	(0.064)	0.032	0.004
256	21.33	0.07	0.024	(0.064)	0.021	0.002
257	21.42	0.07	0.024	(0.063)	0.021	0.002
258	21.50	0.07	0.024	(0.063)	0.021	0.002
259	21.58	0.10	0.035	(0.063)	0.032	0.004
260	21.67	0.10	0.035	(0.063)	0.032	0.004
261	21.75	0.10	0.035	(0.062)	0.032	0.004
262	21.83	0.07	0.024	(0.062)	0.021	0.002
263	21.92	0.07	0.024	(0.062)	0.021	0.002
264	22.00	0.07	0.024	(0.062)	0.021	0.002
265	22.08	0.10	0.035	(0.062)	0.032	0.004
266	22.17	0.10	0.035	(0.061)	0.032	0.004
267	22.25	0.10	0.035	(0.061)	0.032	0.004
268	22.33	0.07	0.024	(0.061)	0.021	0.002
269	22.42	0.07	0.024	(0.061)	0.021	0.002
270	22.50	0.07	0.024	(0.061)	0.021	0.002
271	22.58	0.07	0.024	(0.060)	0.021	0.002
272	22.67	0.07	0.024	(0.060)	0.021	0.002
273	22.75	0.07	0.024	(0.060)	0.021	0.002
274	22.83	0.07	0.024	(0.060)	0.021	0.002
275	22.92	0.07	0.024	(0.060)	0.021	0.002
276	23.00	0.07	0.024	(0.060)	0.021	0.002
277	23.08	0.07	0.024	(0.060)	0.021	0.002
278	23.17	0.07	0.024	(0.059)	0.021	0.002
279	23.25	0.07	0.024	(0.059)	0.021	0.002
280	23.33	0.07	0.024	(0.059)	0.021	0.002
281	23.42	0.07	0.024	(0.059)	0.021	0.002
282	23.50	0.07	0.024	(0.059)	0.021	0.002
283	23.58	0.07	0.024	(0.059)	0.021	0.002
284	23.67	0.07	0.024	(0.059)	0.021	0.002
285	23.75	0.07	0.024	(0.059)	0.021	0.002
286	23.83	0.07	0.024	(0.059)	0.021	0.002
287	23.92	0.07	0.024	(0.059)	0.021	0.002
288	24.00	0.07	0.024	(0.059)	0.021	0.002

(Loss Rate Not Used)

Sum = 100.0

Sum = 15.2

Flood volume = Effective rainfall 1.27(In)
times area 7.1(Ac.)/[(In)/(Ft.)] = 0.7(Ac.Ft)
Total soil loss = 1.68(In)
Total soil loss = 0.989(Ac.Ft)
Total rainfall = 2.95(In)
Flood volume = 32478.2 Cubic Feet
Total soil loss = 43083.3 Cubic Feet

Peak flow rate of this hydrograph = 2.039(CFS)

+++++

24 - H O U R S T O R M
R u n o f f H y d r o g r a p h

Hydrograph in 5 Minute intervals ((CFS))

Time (h+m)	Volume Ac.Ft	Q(CFS)	0	2.5	5.0	7.5	10.0
0+ 5	0.0000	0.00	Q				
0+10	0.0000	0.00	Q				
0+15	0.0001	0.01	Q				
0+20	0.0002	0.01	Q				
0+25	0.0003	0.02	Q				
0+30	0.0004	0.02	Q				
0+35	0.0006	0.02	Q				
0+40	0.0007	0.02	Q				
0+45	0.0009	0.02	Q				
0+50	0.0010	0.02	Q				
0+55	0.0012	0.03	Q				
1+ 0	0.0014	0.03	Q				
1+ 5	0.0016	0.03	Q				
1+10	0.0018	0.03	Q				
1+15	0.0020	0.03	Q				
1+20	0.0022	0.03	Q				
1+25	0.0023	0.03	Q				
1+30	0.0025	0.03	Q				
1+35	0.0027	0.03	Q				
1+40	0.0029	0.03	Q				
1+45	0.0030	0.03	Q				
1+50	0.0032	0.03	Q				
1+55	0.0034	0.03	Q				
2+ 0	0.0036	0.03	Q				
2+ 5	0.0038	0.03	Q				
2+10	0.0041	0.03	Q				
2+15	0.0043	0.03	Q				
2+20	0.0045	0.03	Q				
2+25	0.0047	0.03	Q				
2+30	0.0049	0.03	Q				
2+35	0.0052	0.03	Q				
2+40	0.0054	0.04	Q				
2+45	0.0057	0.04	Q				
2+50	0.0060	0.04	Q				
2+55	0.0062	0.04	Q				
3+ 0	0.0065	0.04	Q				
3+ 5	0.0068	0.04	Q				
3+10	0.0071	0.04	Q				
3+15	0.0074	0.04	Q				
3+20	0.0076	0.04	Q				
3+25	0.0079	0.04	Q				
3+30	0.0082	0.04	Q				
3+35	0.0085	0.04	Q				
3+40	0.0088	0.04	Q				
3+45	0.0091	0.04	Q				
3+50	0.0094	0.04	Q				
3+55	0.0097	0.04	Q				
4+ 0	0.0100	0.05	Q				
4+ 5	0.0103	0.05	Q				
4+10	0.0107	0.05	Q				
4+15	0.0110	0.05	Q				
4+20	0.0113	0.05	Q				
4+25	0.0117	0.05	Q				
4+30	0.0121	0.05	Q				
4+35	0.0124	0.06	Q				
4+40	0.0128	0.06	Q				
4+45	0.0132	0.06	Q				

4+50	0.0136	0.06	Q				
4+55	0.0140	0.06	Q				
5+ 0	0.0145	0.06	Q				
5+ 5	0.0149	0.06	Q				
5+10	0.0153	0.06	Q				
5+15	0.0157	0.06	Q				
5+20	0.0161	0.05	Q				
5+25	0.0165	0.06	Q				
5+30	0.0169	0.06	Q				
5+35	0.0173	0.06	Q				
5+40	0.0177	0.06	Q				
5+45	0.0181	0.06	Q				
5+50	0.0185	0.06	Q				
5+55	0.0190	0.07	QV				
6+ 0	0.0194	0.07	QV				
6+ 5	0.0199	0.07	QV				
6+10	0.0204	0.07	QV				
6+15	0.0209	0.07	QV				
6+20	0.0214	0.07	QV				
6+25	0.0219	0.07	QV				
6+30	0.0224	0.07	QV				
6+35	0.0229	0.07	QV				
6+40	0.0234	0.08	QV				
6+45	0.0240	0.08	QV				
6+50	0.0245	0.08	QV				
6+55	0.0251	0.08	QV				
7+ 0	0.0256	0.08	QV				
7+ 5	0.0262	0.08	QV				
7+10	0.0268	0.08	QV				
7+15	0.0274	0.08	QV				
7+20	0.0279	0.08	QV				
7+25	0.0285	0.09	QV				
7+30	0.0291	0.09	QV				
7+35	0.0298	0.09	QV				
7+40	0.0304	0.09	QV				
7+45	0.0310	0.10	QV				
7+50	0.0317	0.10	QV				
7+55	0.0324	0.10	QV				
8+ 0	0.0331	0.10	QV				
8+ 5	0.0339	0.11	QV				
8+10	0.0349	0.15	QV				
8+15	0.0363	0.20	QV				
8+20	0.0379	0.23	Q V				
8+25	0.0396	0.25	Q V				
8+30	0.0414	0.26	QV				
8+35	0.0433	0.27	QV				
8+40	0.0453	0.30	QV				
8+45	0.0476	0.33	QV				
8+50	0.0501	0.36	QV				
8+55	0.0527	0.39	QV				
9+ 0	0.0556	0.42	QV				
9+ 5	0.0587	0.45	Q V				
9+10	0.0622	0.50	QV				
9+15	0.0661	0.56	QV				
9+20	0.0702	0.60	QV				
9+25	0.0746	0.64	Q V				
9+30	0.0793	0.68	Q V				
9+35	0.0842	0.71	Q V				
9+40	0.0893	0.75	Q V				
9+45	0.0947	0.78	Q V				

14+50	0.5786	1.51		Q				V	
14+55	0.5889	1.49		Q				V	
15+ 0	0.5990	1.47		Q				V	
15+ 5	0.6090	1.46		Q				V	
15+10	0.6189	1.44		Q				V	
15+15	0.6287	1.41		Q				V	
15+20	0.6383	1.40		Q				V	
15+25	0.6478	1.37		Q				V	
15+30	0.6571	1.35		Q				V	
15+35	0.6661	1.32		Q				V	
15+40	0.6747	1.24		Q				V	
15+45	0.6825	1.14		Q				V	
15+50	0.6900	1.09		Q				V	
15+55	0.6973	1.06		Q				V	
16+ 0	0.7045	1.04		Q				V	
16+ 5	0.7113	0.98		Q				V	
16+10	0.7166	0.77		Q				V	
16+15	0.7200	0.49		Q				V	
16+20	0.7223	0.34		Q				V	
16+25	0.7241	0.26		Q				V	
16+30	0.7256	0.21		Q				V	
16+35	0.7268	0.17		Q				V	
16+40	0.7277	0.14		Q				V	
16+45	0.7285	0.11		Q				V	
16+50	0.7291	0.09		Q				V	
16+55	0.7297	0.08		Q				V	
17+ 0	0.7301	0.07		Q				V	
17+ 5	0.7305	0.06		Q				V	
17+10	0.7309	0.05		Q				V	
17+15	0.7312	0.05		Q				V	
17+20	0.7316	0.05		Q				V	
17+25	0.7319	0.05		Q				V	
17+30	0.7322	0.04		Q				V	
17+35	0.7325	0.04		Q				V	
17+40	0.7327	0.04		Q				V	
17+45	0.7330	0.04		Q				V	
17+50	0.7333	0.04		Q				V	
17+55	0.7336	0.04		Q				V	
18+ 0	0.7338	0.04		Q				V	
18+ 5	0.7341	0.04		Q				V	
18+10	0.7343	0.04		Q				V	
18+15	0.7345	0.03		Q				V	
18+20	0.7348	0.03		Q				V	
18+25	0.7350	0.03		Q				V	
18+30	0.7353	0.03		Q				V	
18+35	0.7355	0.03		Q				V	
18+40	0.7357	0.03		Q				V	
18+45	0.7359	0.03		Q				V	
18+50	0.7361	0.03		Q				V	
18+55	0.7363	0.03		Q				V	
19+ 0	0.7364	0.02		Q				V	
19+ 5	0.7366	0.02		Q				V	
19+10	0.7367	0.02		Q				V	
19+15	0.7369	0.02		Q				V	
19+20	0.7370	0.02		Q				V	
19+25	0.7372	0.03		Q				V	
19+30	0.7374	0.03		Q				V	
19+35	0.7376	0.03		Q				V	
19+40	0.7378	0.03		Q				V	
19+45	0.7380	0.03		Q				V	

19+50	0.7382	0.03	Q				V
19+55	0.7384	0.02	Q				V
20+ 0	0.7385	0.02	Q				V
20+ 5	0.7387	0.02	Q				V
20+10	0.7388	0.02	Q				V
20+15	0.7390	0.02	Q				V
20+20	0.7391	0.02	Q				V
20+25	0.7393	0.02	Q				V
20+30	0.7395	0.02	Q				V
20+35	0.7396	0.02	Q				V
20+40	0.7398	0.02	Q				V
20+45	0.7400	0.02	Q				V
20+50	0.7402	0.02	Q				V
20+55	0.7403	0.02	Q				V
21+ 0	0.7404	0.02	Q				V
21+ 5	0.7406	0.02	Q				V
21+10	0.7407	0.02	Q				V
21+15	0.7409	0.02	Q				V
21+20	0.7410	0.02	Q				V
21+25	0.7412	0.02	Q				V
21+30	0.7413	0.02	Q				V
21+35	0.7415	0.02	Q				V
21+40	0.7416	0.02	Q				V
21+45	0.7418	0.02	Q				V
21+50	0.7419	0.02	Q				V
21+55	0.7421	0.02	Q				V
22+ 0	0.7422	0.02	Q				V
22+ 5	0.7423	0.02	Q				V
22+10	0.7425	0.02	Q				V
22+15	0.7426	0.02	Q				V
22+20	0.7428	0.02	Q				V
22+25	0.7429	0.02	Q				V
22+30	0.7431	0.02	Q				V
22+35	0.7432	0.02	Q				V
22+40	0.7433	0.02	Q				V
22+45	0.7434	0.02	Q				V
22+50	0.7436	0.02	Q				V
22+55	0.7437	0.02	Q				V
23+ 0	0.7438	0.02	Q				V
23+ 5	0.7439	0.02	Q				V
23+10	0.7440	0.02	Q				V
23+15	0.7442	0.02	Q				V
23+20	0.7443	0.02	Q				V
23+25	0.7444	0.02	Q				V
23+30	0.7445	0.02	Q				V
23+35	0.7446	0.02	Q				V
23+40	0.7447	0.02	Q				V
23+45	0.7449	0.02	Q				V
23+50	0.7450	0.02	Q				V
23+55	0.7451	0.02	Q				V
24+ 0	0.7452	0.02	Q				V
24+ 5	0.7453	0.02	Q				V
24+10	0.7454	0.01	Q				V
24+15	0.7454	0.01	Q				V
24+20	0.7455	0.01	Q				V
24+25	0.7455	0.00	Q				V
24+30	0.7455	0.00	Q				V
24+35	0.7455	0.00	Q				V
24+40	0.7456	0.00	Q				V
24+45	0.7456	0.00	Q				V

24+50	0.7456	0.00	Q				V
24+55	0.7456	0.00	Q				V
25+ 0	0.7456	0.00	Q				V
25+ 5	0.7456	0.00	Q				V
25+10	0.7456	0.00	Q				V
25+15	0.7456	0.00	Q				V
25+20	0.7456	0.00	Q				V
25+25	0.7456	0.00	Q				V
25+30	0.7456	0.00	Q				V

**PRELIMINARY DRAINAGE ANALYSIS
OLD 215 INDUSTRIAL BUILDING (PEN21-0325 / LST22-0007)
CITY OF MORENO VALLEY, CA**

APPENDIX D

**ON-SITE HYDROLOGY BASED ON PROPOSED CONDITION (UNIT
HYDROGRAPH)**

**PRELIMINARY DRAINAGE ANALYSIS
OLD 215 INDUSTRIAL BUILDING (PEN21-0325 / LST22-0007)
CITY OF MORENO VALLEY, CA**

APPENDIX D.1

10-YEAR HYDROLOGY CALCULATIONS (PROPOSED)

Unit Hydrograph Analysis

Copyright (c) CIVILCADD/CIVILDESIGN, 1989 - 2018, Version 9.0
Study date 03/16/22 File: 102410.out

+++++

Riverside County Synthetic Unit Hydrology Method
RCFC & WCD Manual date - April 1978

Program License Serial Number 6522

English (in-lb) Input Units Used
English Rainfall Data (Inches) Input Values Used

English Units used in output format

1494-0006 OLD 215 FRONTAGE ROAD
PROPOSED CONDITION
10-YEAR, 24-HOUR STORM EVENT

Drainage Area = 7.06(Ac.) = 0.011 Sq. Mi.
Drainage Area for Depth-Area Areal Adjustment = 7.06(Ac.) = 0.011
Sq. Mi.

USER Entry of lag time in hours
Lag time = 0.096 Hr.
Lag time = 5.76 Min.
25% of lag time = 1.44 Min.
40% of lag time = 2.30 Min.
Unit time = 5.00 Min.
Duration of storm = 24 Hour(s)
User Entered Base Flow = 0.00 (CFS)

2 YEAR Area rainfall data:

Area(Ac.) [1]	Rainfall(In) [2]	Weighting[1*2]
7.06	1.85	13.06

100 YEAR Area rainfall data:

Area(Ac.) [1]	Rainfall(In) [2]	Weighting[1*2]
7.06	4.52	31.91

STORM EVENT (YEAR) = 10.00
Area Averaged 2-Year Rainfall = 1.850 (In)
Area Averaged 100-Year Rainfall = 4.520 (In)

Point rain (area averaged) = 2.948 (In)
Areal adjustment factor = 100.00 %

Adjusted average point rain = 2.948(In)

Sub-Area Data:

Area (Ac.)	Runoff Index	Impervious %
6.350	98.00	1.000
0.710	69.00	0.000
Total Area Entered =		7.06 (Ac.)

RI	RI	Infil. Rate	Impervious	Adj. Infil. Rate	Area%	F
AMC2	AMC-2	(In/Hr)	(Dec.%)	(In/Hr)	(Dec.)	(In/Hr)
98.0	98.0	0.026	1.000	0.003	0.899	0.002
69.0	69.0	0.373	0.000	0.373	0.101	0.037
Sum (F) =						0.040

Area averaged mean soil loss (F) (In/Hr) = 0.040

Minimum soil loss rate ((In/Hr)) = 0.020

(for 24 hour storm duration)

Soil low loss rate (decimal) = 0.180

Unit Hydrograph
VALLEY S-Curve

Unit Hydrograph Data

Unit time period (hrs)	Time % of lag	Distribution Graph %	Unit Hydrograph (CFS)
1	0.083	86.806	15.240
2	0.167	173.611	46.398
3	0.250	260.417	18.139
4	0.333	347.222	7.824
5	0.417	434.028	4.605
6	0.500	520.833	2.893
7	0.583	607.639	2.035
8	0.667	694.444	1.334
9	0.750	781.250	0.909
10	0.833	868.056	0.622
Sum = 100.000			Sum= 7.115

The following loss rate calculations reflect use of the minimum calculated loss rate subtracted from the Storm Rain to produce the maximum Effective Rain value

Unit Time (Hr.)	Pattern Percent	Storm Rain (In/Hr)	Loss rate (In./Hr)		Effective (In/Hr)	
			Max	Low		
1	0.08	0.07	0.024	(0.071)	0.004	0.019
2	0.17	0.07	0.024	(0.070)	0.004	0.019
3	0.25	0.07	0.024	(0.070)	0.004	0.019
4	0.33	0.10	0.035	(0.070)	0.006	0.029
5	0.42	0.10	0.035	(0.070)	0.006	0.029
6	0.50	0.10	0.035	(0.069)	0.006	0.029
7	0.58	0.10	0.035	(0.069)	0.006	0.029
8	0.67	0.10	0.035	(0.069)	0.006	0.029
9	0.75	0.10	0.035	(0.068)	0.006	0.029
10	0.83	0.13	0.047	(0.068)	0.008	0.039
11	0.92	0.13	0.047	(0.068)	0.008	0.039
12	1.00	0.13	0.047	(0.068)	0.008	0.039
13	1.08	0.10	0.035	(0.067)	0.006	0.029

14	1.17	0.10	0.035	(0.067)	0.006	0.029
15	1.25	0.10	0.035	(0.067)	0.006	0.029
16	1.33	0.10	0.035	(0.067)	0.006	0.029
17	1.42	0.10	0.035	(0.066)	0.006	0.029
18	1.50	0.10	0.035	(0.066)	0.006	0.029
19	1.58	0.10	0.035	(0.066)	0.006	0.029
20	1.67	0.10	0.035	(0.066)	0.006	0.029
21	1.75	0.10	0.035	(0.065)	0.006	0.029
22	1.83	0.13	0.047	(0.065)	0.008	0.039
23	1.92	0.13	0.047	(0.065)	0.008	0.039
24	2.00	0.13	0.047	(0.064)	0.008	0.039
25	2.08	0.13	0.047	(0.064)	0.008	0.039
26	2.17	0.13	0.047	(0.064)	0.008	0.039
27	2.25	0.13	0.047	(0.064)	0.008	0.039
28	2.33	0.13	0.047	(0.063)	0.008	0.039
29	2.42	0.13	0.047	(0.063)	0.008	0.039
30	2.50	0.13	0.047	(0.063)	0.008	0.039
31	2.58	0.17	0.059	(0.063)	0.011	0.048
32	2.67	0.17	0.059	(0.062)	0.011	0.048
33	2.75	0.17	0.059	(0.062)	0.011	0.048
34	2.83	0.17	0.059	(0.062)	0.011	0.048
35	2.92	0.17	0.059	(0.062)	0.011	0.048
36	3.00	0.17	0.059	(0.061)	0.011	0.048
37	3.08	0.17	0.059	(0.061)	0.011	0.048
38	3.17	0.17	0.059	(0.061)	0.011	0.048
39	3.25	0.17	0.059	(0.061)	0.011	0.048
40	3.33	0.17	0.059	(0.060)	0.011	0.048
41	3.42	0.17	0.059	(0.060)	0.011	0.048
42	3.50	0.17	0.059	(0.060)	0.011	0.048
43	3.58	0.17	0.059	(0.060)	0.011	0.048
44	3.67	0.17	0.059	(0.059)	0.011	0.048
45	3.75	0.17	0.059	(0.059)	0.011	0.048
46	3.83	0.20	0.071	(0.059)	0.013	0.058
47	3.92	0.20	0.071	(0.059)	0.013	0.058
48	4.00	0.20	0.071	(0.058)	0.013	0.058
49	4.08	0.20	0.071	(0.058)	0.013	0.058
50	4.17	0.20	0.071	(0.058)	0.013	0.058
51	4.25	0.20	0.071	(0.058)	0.013	0.058
52	4.33	0.23	0.083	(0.057)	0.015	0.068
53	4.42	0.23	0.083	(0.057)	0.015	0.068
54	4.50	0.23	0.083	(0.057)	0.015	0.068
55	4.58	0.23	0.083	(0.057)	0.015	0.068
56	4.67	0.23	0.083	(0.056)	0.015	0.068
57	4.75	0.23	0.083	(0.056)	0.015	0.068
58	4.83	0.27	0.094	(0.056)	0.017	0.077
59	4.92	0.27	0.094	(0.056)	0.017	0.077
60	5.00	0.27	0.094	(0.055)	0.017	0.077
61	5.08	0.20	0.071	(0.055)	0.013	0.058
62	5.17	0.20	0.071	(0.055)	0.013	0.058
63	5.25	0.20	0.071	(0.055)	0.013	0.058
64	5.33	0.23	0.083	(0.054)	0.015	0.068
65	5.42	0.23	0.083	(0.054)	0.015	0.068
66	5.50	0.23	0.083	(0.054)	0.015	0.068
67	5.58	0.27	0.094	(0.054)	0.017	0.077
68	5.67	0.27	0.094	(0.054)	0.017	0.077
69	5.75	0.27	0.094	(0.053)	0.017	0.077
70	5.83	0.27	0.094	(0.053)	0.017	0.077
71	5.92	0.27	0.094	(0.053)	0.017	0.077
72	6.00	0.27	0.094	(0.053)	0.017	0.077
73	6.08	0.30	0.106	(0.052)	0.019	0.087

74	6.17	0.30	0.106	(0.052)	0.019	0.087
75	6.25	0.30	0.106	(0.052)	0.019	0.087
76	6.33	0.30	0.106	(0.052)	0.019	0.087
77	6.42	0.30	0.106	(0.051)	0.019	0.087
78	6.50	0.30	0.106	(0.051)	0.019	0.087
79	6.58	0.33	0.118	(0.051)	0.021	0.097
80	6.67	0.33	0.118	(0.051)	0.021	0.097
81	6.75	0.33	0.118	(0.050)	0.021	0.097
82	6.83	0.33	0.118	(0.050)	0.021	0.097
83	6.92	0.33	0.118	(0.050)	0.021	0.097
84	7.00	0.33	0.118	(0.050)	0.021	0.097
85	7.08	0.33	0.118	(0.050)	0.021	0.097
86	7.17	0.33	0.118	(0.049)	0.021	0.097
87	7.25	0.33	0.118	(0.049)	0.021	0.097
88	7.33	0.37	0.130	(0.049)	0.023	0.106
89	7.42	0.37	0.130	(0.049)	0.023	0.106
90	7.50	0.37	0.130	(0.048)	0.023	0.106
91	7.58	0.40	0.142	(0.048)	0.025	0.116
92	7.67	0.40	0.142	(0.048)	0.025	0.116
93	7.75	0.40	0.142	(0.048)	0.025	0.116
94	7.83	0.43	0.153	(0.048)	0.028	0.126
95	7.92	0.43	0.153	(0.047)	0.028	0.126
96	8.00	0.43	0.153	(0.047)	0.028	0.126
97	8.08	0.50	0.177	(0.047)	0.032	0.145
98	8.17	0.50	0.177	(0.047)	0.032	0.145
99	8.25	0.50	0.177	(0.046)	0.032	0.145
100	8.33	0.50	0.177	(0.046)	0.032	0.145
101	8.42	0.50	0.177	(0.046)	0.032	0.145
102	8.50	0.50	0.177	(0.046)	0.032	0.145
103	8.58	0.53	0.189	(0.046)	0.034	0.155
104	8.67	0.53	0.189	(0.045)	0.034	0.155
105	8.75	0.53	0.189	(0.045)	0.034	0.155
106	8.83	0.57	0.200	(0.045)	0.036	0.164
107	8.92	0.57	0.200	(0.045)	0.036	0.164
108	9.00	0.57	0.200	(0.045)	0.036	0.164
109	9.08	0.63	0.224	(0.044)	0.040	0.184
110	9.17	0.63	0.224	(0.044)	0.040	0.184
111	9.25	0.63	0.224	(0.044)	0.040	0.184
112	9.33	0.67	0.236	(0.044)	0.042	0.193
113	9.42	0.67	0.236	(0.044)	0.042	0.193
114	9.50	0.67	0.236	(0.043)	0.042	0.193
115	9.58	0.70	0.248	0.043	(0.045)	0.205
116	9.67	0.70	0.248	0.043	(0.045)	0.205
117	9.75	0.70	0.248	0.043	(0.045)	0.205
118	9.83	0.73	0.259	0.042	(0.047)	0.217
119	9.92	0.73	0.259	0.042	(0.047)	0.217
120	10.00	0.73	0.259	0.042	(0.047)	0.217
121	10.08	0.50	0.177	(0.042)	0.032	0.145
122	10.17	0.50	0.177	(0.042)	0.032	0.145
123	10.25	0.50	0.177	(0.041)	0.032	0.145
124	10.33	0.50	0.177	(0.041)	0.032	0.145
125	10.42	0.50	0.177	(0.041)	0.032	0.145
126	10.50	0.50	0.177	(0.041)	0.032	0.145
127	10.58	0.67	0.236	0.041	(0.042)	0.195
128	10.67	0.67	0.236	0.040	(0.042)	0.195
129	10.75	0.67	0.236	0.040	(0.042)	0.196
130	10.83	0.67	0.236	0.040	(0.042)	0.196
131	10.92	0.67	0.236	0.040	(0.042)	0.196
132	11.00	0.67	0.236	0.040	(0.042)	0.196
133	11.08	0.63	0.224	0.039	(0.040)	0.185

134	11.17	0.63	0.224	0.039	(0.040)	0.185
135	11.25	0.63	0.224	0.039	(0.040)	0.185
136	11.33	0.63	0.224	0.039	(0.040)	0.185
137	11.42	0.63	0.224	0.039	(0.040)	0.185
138	11.50	0.63	0.224	0.039	(0.040)	0.186
139	11.58	0.57	0.200	(0.038)	0.036	0.164
140	11.67	0.57	0.200	(0.038)	0.036	0.164
141	11.75	0.57	0.200	(0.038)	0.036	0.164
142	11.83	0.60	0.212	0.038	(0.038)	0.175
143	11.92	0.60	0.212	0.038	(0.038)	0.175
144	12.00	0.60	0.212	0.037	(0.038)	0.175
145	12.08	0.83	0.295	0.037	(0.053)	0.258
146	12.17	0.83	0.295	0.037	(0.053)	0.258
147	12.25	0.83	0.295	0.037	(0.053)	0.258
148	12.33	0.87	0.307	0.037	(0.055)	0.270
149	12.42	0.87	0.307	0.036	(0.055)	0.270
150	12.50	0.87	0.307	0.036	(0.055)	0.270
151	12.58	0.93	0.330	0.036	(0.059)	0.294
152	12.67	0.93	0.330	0.036	(0.059)	0.294
153	12.75	0.93	0.330	0.036	(0.059)	0.295
154	12.83	0.97	0.342	0.036	(0.062)	0.306
155	12.92	0.97	0.342	0.035	(0.062)	0.307
156	13.00	0.97	0.342	0.035	(0.062)	0.307
157	13.08	1.13	0.401	0.035	(0.072)	0.366
158	13.17	1.13	0.401	0.035	(0.072)	0.366
159	13.25	1.13	0.401	0.035	(0.072)	0.366
160	13.33	1.13	0.401	0.034	(0.072)	0.367
161	13.42	1.13	0.401	0.034	(0.072)	0.367
162	13.50	1.13	0.401	0.034	(0.072)	0.367
163	13.58	0.77	0.271	0.034	(0.049)	0.237
164	13.67	0.77	0.271	0.034	(0.049)	0.237
165	13.75	0.77	0.271	0.034	(0.049)	0.238
166	13.83	0.77	0.271	0.033	(0.049)	0.238
167	13.92	0.77	0.271	0.033	(0.049)	0.238
168	14.00	0.77	0.271	0.033	(0.049)	0.238
169	14.08	0.90	0.318	0.033	(0.057)	0.286
170	14.17	0.90	0.318	0.033	(0.057)	0.286
171	14.25	0.90	0.318	0.033	(0.057)	0.286
172	14.33	0.87	0.307	0.032	(0.055)	0.274
173	14.42	0.87	0.307	0.032	(0.055)	0.274
174	14.50	0.87	0.307	0.032	(0.055)	0.275
175	14.58	0.87	0.307	0.032	(0.055)	0.275
176	14.67	0.87	0.307	0.032	(0.055)	0.275
177	14.75	0.87	0.307	0.032	(0.055)	0.275
178	14.83	0.83	0.295	0.031	(0.053)	0.263
179	14.92	0.83	0.295	0.031	(0.053)	0.264
180	15.00	0.83	0.295	0.031	(0.053)	0.264
181	15.08	0.80	0.283	0.031	(0.051)	0.252
182	15.17	0.80	0.283	0.031	(0.051)	0.252
183	15.25	0.80	0.283	0.031	(0.051)	0.252
184	15.33	0.77	0.271	0.030	(0.049)	0.241
185	15.42	0.77	0.271	0.030	(0.049)	0.241
186	15.50	0.77	0.271	0.030	(0.049)	0.241
187	15.58	0.63	0.224	0.030	(0.040)	0.194
188	15.67	0.63	0.224	0.030	(0.040)	0.194
189	15.75	0.63	0.224	0.030	(0.040)	0.194
190	15.83	0.63	0.224	0.030	(0.040)	0.195
191	15.92	0.63	0.224	0.029	(0.040)	0.195
192	16.00	0.63	0.224	0.029	(0.040)	0.195
193	16.08	0.13	0.047	(0.029)	0.008	0.039

194	16.17	0.13	0.047	(0.029)	0.008	0.039
195	16.25	0.13	0.047	(0.029)	0.008	0.039
196	16.33	0.13	0.047	(0.029)	0.008	0.039
197	16.42	0.13	0.047	(0.029)	0.008	0.039
198	16.50	0.13	0.047	(0.028)	0.008	0.039
199	16.58	0.10	0.035	(0.028)	0.006	0.029
200	16.67	0.10	0.035	(0.028)	0.006	0.029
201	16.75	0.10	0.035	(0.028)	0.006	0.029
202	16.83	0.10	0.035	(0.028)	0.006	0.029
203	16.92	0.10	0.035	(0.028)	0.006	0.029
204	17.00	0.10	0.035	(0.028)	0.006	0.029
205	17.08	0.17	0.059	(0.027)	0.011	0.048
206	17.17	0.17	0.059	(0.027)	0.011	0.048
207	17.25	0.17	0.059	(0.027)	0.011	0.048
208	17.33	0.17	0.059	(0.027)	0.011	0.048
209	17.42	0.17	0.059	(0.027)	0.011	0.048
210	17.50	0.17	0.059	(0.027)	0.011	0.048
211	17.58	0.17	0.059	(0.027)	0.011	0.048
212	17.67	0.17	0.059	(0.026)	0.011	0.048
213	17.75	0.17	0.059	(0.026)	0.011	0.048
214	17.83	0.13	0.047	(0.026)	0.008	0.039
215	17.92	0.13	0.047	(0.026)	0.008	0.039
216	18.00	0.13	0.047	(0.026)	0.008	0.039
217	18.08	0.13	0.047	(0.026)	0.008	0.039
218	18.17	0.13	0.047	(0.026)	0.008	0.039
219	18.25	0.13	0.047	(0.026)	0.008	0.039
220	18.33	0.13	0.047	(0.025)	0.008	0.039
221	18.42	0.13	0.047	(0.025)	0.008	0.039
222	18.50	0.13	0.047	(0.025)	0.008	0.039
223	18.58	0.10	0.035	(0.025)	0.006	0.029
224	18.67	0.10	0.035	(0.025)	0.006	0.029
225	18.75	0.10	0.035	(0.025)	0.006	0.029
226	18.83	0.07	0.024	(0.025)	0.004	0.019
227	18.92	0.07	0.024	(0.025)	0.004	0.019
228	19.00	0.07	0.024	(0.024)	0.004	0.019
229	19.08	0.10	0.035	(0.024)	0.006	0.029
230	19.17	0.10	0.035	(0.024)	0.006	0.029
231	19.25	0.10	0.035	(0.024)	0.006	0.029
232	19.33	0.13	0.047	(0.024)	0.008	0.039
233	19.42	0.13	0.047	(0.024)	0.008	0.039
234	19.50	0.13	0.047	(0.024)	0.008	0.039
235	19.58	0.10	0.035	(0.024)	0.006	0.029
236	19.67	0.10	0.035	(0.024)	0.006	0.029
237	19.75	0.10	0.035	(0.023)	0.006	0.029
238	19.83	0.07	0.024	(0.023)	0.004	0.019
239	19.92	0.07	0.024	(0.023)	0.004	0.019
240	20.00	0.07	0.024	(0.023)	0.004	0.019
241	20.08	0.10	0.035	(0.023)	0.006	0.029
242	20.17	0.10	0.035	(0.023)	0.006	0.029
243	20.25	0.10	0.035	(0.023)	0.006	0.029
244	20.33	0.10	0.035	(0.023)	0.006	0.029
245	20.42	0.10	0.035	(0.023)	0.006	0.029
246	20.50	0.10	0.035	(0.023)	0.006	0.029
247	20.58	0.10	0.035	(0.022)	0.006	0.029
248	20.67	0.10	0.035	(0.022)	0.006	0.029
249	20.75	0.10	0.035	(0.022)	0.006	0.029
250	20.83	0.07	0.024	(0.022)	0.004	0.019
251	20.92	0.07	0.024	(0.022)	0.004	0.019
252	21.00	0.07	0.024	(0.022)	0.004	0.019
253	21.08	0.10	0.035	(0.022)	0.006	0.029

254	21.17	0.10	0.035	(0.022)	0.006	0.029
255	21.25	0.10	0.035	(0.022)	0.006	0.029
256	21.33	0.07	0.024	(0.022)	0.004	0.019
257	21.42	0.07	0.024	(0.022)	0.004	0.019
258	21.50	0.07	0.024	(0.021)	0.004	0.019
259	21.58	0.10	0.035	(0.021)	0.006	0.029
260	21.67	0.10	0.035	(0.021)	0.006	0.029
261	21.75	0.10	0.035	(0.021)	0.006	0.029
262	21.83	0.07	0.024	(0.021)	0.004	0.019
263	21.92	0.07	0.024	(0.021)	0.004	0.019
264	22.00	0.07	0.024	(0.021)	0.004	0.019
265	22.08	0.10	0.035	(0.021)	0.006	0.029
266	22.17	0.10	0.035	(0.021)	0.006	0.029
267	22.25	0.10	0.035	(0.021)	0.006	0.029
268	22.33	0.07	0.024	(0.021)	0.004	0.019
269	22.42	0.07	0.024	(0.021)	0.004	0.019
270	22.50	0.07	0.024	(0.021)	0.004	0.019
271	22.58	0.07	0.024	(0.021)	0.004	0.019
272	22.67	0.07	0.024	(0.021)	0.004	0.019
273	22.75	0.07	0.024	(0.020)	0.004	0.019
274	22.83	0.07	0.024	(0.020)	0.004	0.019
275	22.92	0.07	0.024	(0.020)	0.004	0.019
276	23.00	0.07	0.024	(0.020)	0.004	0.019
277	23.08	0.07	0.024	(0.020)	0.004	0.019
278	23.17	0.07	0.024	(0.020)	0.004	0.019
279	23.25	0.07	0.024	(0.020)	0.004	0.019
280	23.33	0.07	0.024	(0.020)	0.004	0.019
281	23.42	0.07	0.024	(0.020)	0.004	0.019
282	23.50	0.07	0.024	(0.020)	0.004	0.019
283	23.58	0.07	0.024	(0.020)	0.004	0.019
284	23.67	0.07	0.024	(0.020)	0.004	0.019
285	23.75	0.07	0.024	(0.020)	0.004	0.019
286	23.83	0.07	0.024	(0.020)	0.004	0.019
287	23.92	0.07	0.024	(0.020)	0.004	0.019
288	24.00	0.07	0.024	(0.020)	0.004	0.019

(Loss Rate Not Used)

Sum = 100.0 Sum = 30.1

Flood volume = Effective rainfall 2.51(In)
times area 7.1(Ac.)/[(In)/(Ft.)] = 1.5(Ac.Ft)
Total soil loss = 0.44(In)
Total soil loss = 0.260(Ac.Ft)
Total rainfall = 2.95(In)
Flood volume = 64250.3 Cubic Feet
Total soil loss = 11311.2 Cubic Feet

Peak flow rate of this hydrograph = 2.588(CFS)

+++++

24 - H O U R S T O R M
R u n o f f H y d r o g r a p h

Hydrograph in 5 Minute intervals ((CFS))

Time(h+m)	Volume Ac.Ft	Q(CFS)	0	2.5	5.0	7.5	10.0
0+ 5	0.0001	0.02	Q				
0+10	0.0007	0.08	Q				
0+15	0.0015	0.11	Q				
0+20	0.0024	0.13	Q				

0+25	0.0036	0.17	Q				
0+30	0.0048	0.19	Q				
0+35	0.0062	0.19	Q				
0+40	0.0075	0.20	Q				
0+45	0.0089	0.20	Q				
0+50	0.0104	0.22	Q				
0+55	0.0121	0.25	Q				
1+ 0	0.0139	0.26	VQ				
1+ 5	0.0157	0.26	VQ				
1+10	0.0173	0.23	Q				
1+15	0.0188	0.22	Q				
1+20	0.0202	0.21	Q				
1+25	0.0217	0.21	Q				
1+30	0.0231	0.21	Q				
1+35	0.0245	0.21	Q				
1+40	0.0260	0.21	Q				
1+45	0.0274	0.21	Q				
1+50	0.0289	0.22	Q				
1+55	0.0306	0.25	Q				
2+ 0	0.0324	0.26	VQ				
2+ 5	0.0343	0.27	VQ				
2+10	0.0361	0.27	VQ				
2+15	0.0380	0.27	IQ				
2+20	0.0399	0.27	IQ				
2+25	0.0418	0.27	IQ				
2+30	0.0437	0.27	IQ				
2+35	0.0456	0.29	IQ				
2+40	0.0478	0.32	IQ				
2+45	0.0501	0.33	IQ				
2+50	0.0524	0.34	IQ				
2+55	0.0547	0.34	IQ				
3+ 0	0.0571	0.34	IQ				
3+ 5	0.0594	0.34	IQ				
3+10	0.0618	0.34	IQ				
3+15	0.0642	0.34	IQ				
3+20	0.0665	0.34	IQ				
3+25	0.0689	0.34	IQ				
3+30	0.0713	0.34	IQ				
3+35	0.0736	0.34	IQ				
3+40	0.0760	0.34	IQV				
3+45	0.0784	0.34	IQV				
3+50	0.0808	0.35	IQV				
3+55	0.0835	0.39	IQV				
4+ 0	0.0862	0.40	IQV				
4+ 5	0.0890	0.40	IQV				
4+10	0.0918	0.41	IQV				
4+15	0.0947	0.41	IQV				
4+20	0.0976	0.42	IQV				
4+25	0.1007	0.45	IQV				
4+30	0.1039	0.47	IQV				
4+35	0.1072	0.47	IQV				
4+40	0.1105	0.48	IQV				
4+45	0.1137	0.48	IQ V				
4+50	0.1171	0.49	IQ V				
4+55	0.1207	0.52	IQV				
5+ 0	0.1244	0.54	IQV				
5+ 5	0.1280	0.52	IQV				
5+10	0.1312	0.46	IQ V				
5+15	0.1342	0.44	IQ V				
5+20	0.1372	0.44	IQ V				

5+25	0.1404	0.47	Q V				
5+30	0.1437	0.47	Q V				
5+35	0.1471	0.49	Q V				
5+40	0.1506	0.52	Q V				
5+45	0.1543	0.53	Q V				
5+50	0.1580	0.54	Q V				
5+55	0.1618	0.54	Q V				
6+ 0	0.1656	0.55	Q V				
6+ 5	0.1694	0.56	Q V				
6+10	0.1735	0.59	Q V				
6+15	0.1777	0.61	Q V				
6+20	0.1819	0.61	Q V				
6+25	0.1861	0.61	Q V				
6+30	0.1903	0.62	Q V				
6+35	0.1947	0.63	Q V				
6+40	0.1992	0.66	Q V				
6+45	0.2039	0.67	Q V				
6+50	0.2085	0.68	Q V				
6+55	0.2132	0.68	Q V				
7+ 0	0.2180	0.69	Q V				
7+ 5	0.2227	0.69	Q V				
7+10	0.2274	0.69	Q V				
7+15	0.2322	0.69	Q V				
7+20	0.2370	0.70	Q V				
7+25	0.2420	0.73	Q V				
7+30	0.2471	0.74	Q V				
7+35	0.2524	0.76	Q V				
7+40	0.2578	0.79	Q V				
7+45	0.2634	0.81	Q V				
7+50	0.2691	0.83	Q V				
7+55	0.2750	0.86	Q V				
8+ 0	0.2811	0.88	Q V				
8+ 5	0.2873	0.91	Q V				
8+10	0.2940	0.97	Q V				
8+15	0.3009	1.00	Q V				
8+20	0.3079	1.01	Q V				
8+25	0.3149	1.02	Q V				
8+30	0.3220	1.03	Q V				
8+35	0.3291	1.04	Q V				
8+40	0.3365	1.07	Q V				
8+45	0.3440	1.09	Q V				
8+50	0.3516	1.10	Q V				
8+55	0.3595	1.14	Q V				
9+ 0	0.3674	1.15	Q V				
9+ 5	0.3755	1.18	Q V				
9+10	0.3841	1.25	Q V				
9+15	0.3929	1.28	Q V				
9+20	0.4019	1.30	Q V				
9+25	0.4111	1.34	Q V				
9+30	0.4204	1.36	Q V				
9+35	0.4299	1.38	Q V				
9+40	0.4397	1.42	Q V				
9+45	0.4496	1.44	Q V				
9+50	0.4596	1.46	Q V				
9+55	0.4700	1.50	Q V				
10+ 0	0.4805	1.52	Q V				
10+ 5	0.4905	1.46	Q V				
10+10	0.4989	1.22	Q V				
10+15	0.5067	1.13	Q V				
10+20	0.5142	1.09	Q V				

10+25	0.5216	1.07	Q	V					
10+30	0.5289	1.06	Q	V					
10+35	0.5365	1.10	Q	V					
10+40	0.5452	1.26	Q	V					
10+45	0.5543	1.32	Q	V					
10+50	0.5636	1.35	Q	V					
10+55	0.5730	1.37	Q	V					
11+ 0	0.5825	1.38	Q	V					
11+ 5	0.5919	1.37	Q	V					
11+10	0.6011	1.34	Q	V					
11+15	0.6103	1.33	Q	V					
11+20	0.6194	1.33	Q	V					
11+25	0.6285	1.32	Q	V					
11+30	0.6377	1.32	Q	V					
11+35	0.6466	1.30	Q	V					
11+40	0.6551	1.23	Q	V					
11+45	0.6633	1.20	Q	V					
11+50	0.6716	1.20	Q	V					
11+55	0.6800	1.23	Q	V					
12+ 0	0.6886	1.24	Q	V					
12+ 5	0.6977	1.33	Q	V					
12+10	0.7088	1.60	Q	V					
12+15	0.7206	1.71	Q	V					
12+20	0.7328	1.77	Q	V					
12+25	0.7455	1.84	Q	V					
12+30	0.7584	1.88	Q	V					
12+35	0.7716	1.92	Q	V					
12+40	0.7855	2.01	Q	V					
12+45	0.7996	2.05	Q	V					
12+50	0.8140	2.09	Q	V					
12+55	0.8287	2.13	Q	V					
13+ 0	0.8435	2.16	Q	V					
13+ 5	0.8589	2.23	Q	V					
13+10	0.8757	2.43	Q	V					
13+15	0.8930	2.52	Q	V					
13+20	0.9106	2.55	Q	V					
13+25	0.9283	2.57	Q	V					
13+30	0.9461	2.59	Q	V					
13+35	0.9631	2.46	Q	V					
13+40	0.9771	2.04	Q	V					
13+45	0.9900	1.87	Q	V					
13+50	1.0024	1.81	Q	V					
13+55	1.0146	1.76	Q	V					
14+ 0	1.0266	1.74	Q	V					
14+ 5	1.0388	1.77	Q	V					
14+10	1.0520	1.92	Q	V					
14+15	1.0655	1.97	Q	V					
14+20	1.0792	1.98	Q	V					
14+25	1.0927	1.96	Q	V					
14+30	1.1061	1.95	Q	V					
14+35	1.1196	1.95	Q	V					
14+40	1.1330	1.96	Q	V					
14+45	1.1465	1.96	Q	V					
14+50	1.1599	1.95	Q	V					
14+55	1.1731	1.91	Q	V					
15+ 0	1.1861	1.89	Q	V					
15+ 5	1.1990	1.87	Q	V					
15+10	1.2116	1.83	Q	V					
15+15	1.2241	1.82	Q	V					
15+20	1.2365	1.80	Q	V					

15+25	1.2486	1.75			Q				V	
15+30	1.2605	1.74			Q				V	
15+35	1.2721	1.68			Q				V	
15+40	1.2825	1.52			Q				V	
15+45	1.2926	1.45			Q				V	
15+50	1.3024	1.43			Q				V	
15+55	1.3121	1.41			Q				V	
16+ 0	1.3218	1.40			Q				V	
16+ 5	1.3302	1.23		Q					V	
16+10	1.3351	0.71		Q					V	
16+15	1.3385	0.50		Q					V	
16+20	1.3414	0.41		Q					V	
16+25	1.3439	0.36		Q					V	
16+30	1.3461	0.33		Q					V	
16+35	1.3482	0.30		Q					V	
16+40	1.3499	0.25		Q					V	
16+45	1.3515	0.23		Q					V	
16+50	1.3529	0.22		Q					V	
16+55	1.3544	0.21		Q					V	
17+ 0	1.3559	0.21		Q					V	
17+ 5	1.3574	0.23		Q					V	
17+10	1.3594	0.29		Q					V	
17+15	1.3616	0.32		Q					V	
17+20	1.3639	0.33		Q					V	
17+25	1.3662	0.33		Q					V	
17+30	1.3685	0.34		Q					V	
17+35	1.3708	0.34		Q					V	
17+40	1.3732	0.34		Q					V	
17+45	1.3756	0.34		Q					V	
17+50	1.3779	0.33		Q					V	
17+55	1.3799	0.30		Q					V	
18+ 0	1.3819	0.29		Q					V	
18+ 5	1.3839	0.28		Q					V	
18+10	1.3858	0.28		Q					V	
18+15	1.3877	0.28		Q					V	
18+20	1.3897	0.28		Q					V	
18+25	1.3916	0.28		Q					V	
18+30	1.3935	0.28		Q					V	
18+35	1.3953	0.26		Q					V	
18+40	1.3969	0.23		Q					V	
18+45	1.3984	0.22		Q					V	
18+50	1.3998	0.20		Q					V	
18+55	1.4010	0.17		Q					V	
19+ 0	1.4021	0.15		Q					V	
19+ 5	1.4031	0.16		Q					V	
19+10	1.4044	0.19		Q					V	
19+15	1.4058	0.20		Q					V	
19+20	1.4072	0.21		Q					V	
19+25	1.4089	0.24		Q					V	
19+30	1.4107	0.26		Q					V	
19+35	1.4124	0.25		Q					V	
19+40	1.4140	0.23		Q					V	
19+45	1.4155	0.22		Q					V	
19+50	1.4169	0.20		Q					V	
19+55	1.4181	0.17		Q					V	
20+ 0	1.4191	0.15		Q					V	
20+ 5	1.4202	0.16		Q					V	
20+10	1.4215	0.19		Q					V	
20+15	1.4229	0.20		Q					V	
20+20	1.4242	0.20		Q					V	

20+25	1.4256	0.20	Q				V	
20+30	1.4270	0.20	Q				V	
20+35	1.4284	0.20	Q				V	
20+40	1.4298	0.21	Q				V	
20+45	1.4313	0.21	Q				V	
20+50	1.4326	0.20	Q				V	
20+55	1.4337	0.16	Q				V	
21+ 0	1.4348	0.15	Q				V	
21+ 5	1.4359	0.16	Q				V	
21+10	1.4371	0.19	Q				V	
21+15	1.4385	0.20	Q				V	
21+20	1.4398	0.19	Q				V	
21+25	1.4409	0.16	Q				V	
21+30	1.4419	0.15	Q				V	
21+35	1.4430	0.15	Q				V	
21+40	1.4443	0.18	Q				V	
21+45	1.4456	0.20	Q				V	
21+50	1.4469	0.19	Q				V	
21+55	1.4480	0.16	Q				V	
22+ 0	1.4490	0.15	Q				V	
22+ 5	1.4501	0.15	Q				V	
22+10	1.4514	0.18	Q				V	
22+15	1.4527	0.20	Q				V	
22+20	1.4540	0.19	Q				V	
22+25	1.4551	0.16	Q				V	
22+30	1.4562	0.15	Q				V	
22+35	1.4571	0.14	Q				V	
22+40	1.4581	0.14	Q				V	
22+45	1.4591	0.14	Q				V	
22+50	1.4601	0.14	Q				V	
22+55	1.4610	0.14	Q				V	
23+ 0	1.4620	0.14	Q				V	
23+ 5	1.4629	0.14	Q				V	
23+10	1.4639	0.14	Q				V	
23+15	1.4648	0.14	Q				V	
23+20	1.4658	0.14	Q				V	
23+25	1.4667	0.14	Q				V	
23+30	1.4676	0.14	Q				V	
23+35	1.4686	0.14	Q				V	
23+40	1.4695	0.14	Q				V	
23+45	1.4705	0.14	Q				V	
23+50	1.4714	0.14	Q				V	
23+55	1.4724	0.14	Q				V	
24+ 0	1.4733	0.14	Q				V	
24+ 5	1.4741	0.12	Q				V	
24+10	1.4745	0.05	Q				V	
24+15	1.4747	0.03	Q				V	
24+20	1.4748	0.02	Q				V	
24+25	1.4749	0.01	Q				V	
24+30	1.4749	0.01	Q				V	
24+35	1.4750	0.00	Q				V	
24+40	1.4750	0.00	Q				V	
24+45	1.4750	0.00	Q				V	

**PRELIMINARY DRAINAGE ANALYSIS
OLD 215 INDUSTRIAL BUILDING (PEN21-0325 / LST22-0007)
CITY OF MORENO VALLEY, CA**

APPENDIX E

**OFF-SITE HYDROLOGY BASED ON EXISTING CONDITION FOR
PUBLIC STORM DRAIN**

**PRELIMINARY DRAINAGE ANALYSIS
OLD 215 INDUSTRIAL BUILDING (PEN21-0325 / LST22-0007)
CITY OF MORENO VALLEY, CA**

APPENDIX E.1

100-YEAR HYDROLOGY CALCULATIONS (AREA B1, OLD 215)

Unit Hydrograph Analysis

Copyright (c) CIVILCADD/CIVILDESIGN, 1989 - 2018, Version 9.0
Study date 03/17/22 File: 100B124100.out

+++++

Riverside County Synthetic Unit Hydrology Method
RCFC & WCD Manual date - April 1978

Program License Serial Number 6522

English (in-lb) Input Units Used
English Rainfall Data (Inches) Input Values Used

English Units used in output format

1494-0006 OLD 215 FRONTAGE ROAD
EXISTING CONDITION
100-YEAR, 24-HOUR STORM
OFF SITE, B1

Drainage Area = 51.65(Ac.) = 0.081 Sq. Mi.
Drainage Area for Depth-Area Areal Adjustment = 51.65(Ac.) = 0.081

Sq. Mi.

Length along longest watercourse = 2665.00(Ft.)
Length along longest watercourse measured to centroid = 1131.00(Ft.)
Length along longest watercourse = 0.505 Mi.
Length along longest watercourse measured to centroid = 0.214 Mi.
Difference in elevation = 17.50(Ft.)
Slope along watercourse = 34.6717 Ft./Mi.
Average Manning's 'N' = 0.025
Lag time = 0.131 Hr.
Lag time = 7.88 Min.
25% of lag time = 1.97 Min.
40% of lag time = 3.15 Min.
Unit time = 5.00 Min.
Duration of storm = 24 Hour(s)
User Entered Base Flow = 0.00(CFS)

2 YEAR Area rainfall data:

Area(Ac.) [1]	Rainfall(In) [2]	Weighting[1*2]
51.65	1.85	95.55

100 YEAR Area rainfall data:

Area(Ac.) [1]	Rainfall(In) [2]	Weighting[1*2]
51.65	4.52	233.46

STORM EVENT (YEAR) = 100.00
 Area Averaged 2-Year Rainfall = 1.850 (In)
 Area Averaged 100-Year Rainfall = 4.520 (In)

Point rain (area averaged) = 4.520 (In)
 Areal adjustment factor = 99.99 %
 Adjusted average point rain = 4.520 (In)

Sub-Area Data:

Area (Ac.) Runoff Index Impervious %
 51.650 86.00 0.300
 Total Area Entered = 51.65 (Ac.)

RI	RI	Infil. Rate	Impervious	Adj. Infil. Rate	Area%	F
AMC2	AMC-3	(In/Hr)	(Dec.%)	(In/Hr)	(Dec.)	(In/Hr)
86.0	94.4	0.073	0.300	0.053	1.000	0.053
						Sum (F) = 0.053

Area averaged mean soil loss (F) (In/Hr) = 0.053
 Minimum soil loss rate ((In/Hr)) = 0.027
 (for 24 hour storm duration)
 Soil low loss rate (decimal) = 0.660

 U n i t H y d r o g r a p h
 VALLEY S-Curve

Unit Hydrograph Data

Unit time period (hrs)	Time % of lag	Distribution Graph %	Unit Hydrograph (CFS)
1	0.083	63.443	9.013
2	0.167	126.886	36.293
3	0.250	190.329	25.411
4	0.333	253.772	9.775
5	0.417	317.215	5.877
6	0.500	380.658	3.947
7	0.583	444.101	2.743
8	0.667	507.544	2.010
9	0.750	570.987	1.579
10	0.833	634.430	1.161
11	0.917	697.873	0.842
12	1.000	761.316	0.642
13	1.083	824.759	0.704
Sum = 100.000			Sum= 52.054

 The following loss rate calculations reflect use of the minimum calculated loss rate subtracted from the Storm Rain to produce the maximum Effective Rain value

Unit Time (Hr.)	Pattern Percent	Storm Rain (In/Hr)	Loss rate (In./Hr)		Effective (In/Hr)
			Max	Low	
1	0.08	0.036	(0.094)	0.024	0.012
2	0.17	0.036	(0.094)	0.024	0.012
3	0.25	0.036	(0.093)	0.024	0.012
4	0.33	0.054	(0.093)	0.036	0.018
5	0.42	0.054	(0.093)	0.036	0.018
6	0.50	0.054	(0.092)	0.036	0.018

7	0.58	0.10	0.054	(0.092)	0.036	0.018
8	0.67	0.10	0.054	(0.092)	0.036	0.018
9	0.75	0.10	0.054	(0.091)	0.036	0.018
10	0.83	0.13	0.072	(0.091)	0.048	0.025
11	0.92	0.13	0.072	(0.091)	0.048	0.025
12	1.00	0.13	0.072	(0.090)	0.048	0.025
13	1.08	0.10	0.054	(0.090)	0.036	0.018
14	1.17	0.10	0.054	(0.090)	0.036	0.018
15	1.25	0.10	0.054	(0.089)	0.036	0.018
16	1.33	0.10	0.054	(0.089)	0.036	0.018
17	1.42	0.10	0.054	(0.088)	0.036	0.018
18	1.50	0.10	0.054	(0.088)	0.036	0.018
19	1.58	0.10	0.054	(0.088)	0.036	0.018
20	1.67	0.10	0.054	(0.087)	0.036	0.018
21	1.75	0.10	0.054	(0.087)	0.036	0.018
22	1.83	0.13	0.072	(0.087)	0.048	0.025
23	1.92	0.13	0.072	(0.086)	0.048	0.025
24	2.00	0.13	0.072	(0.086)	0.048	0.025
25	2.08	0.13	0.072	(0.086)	0.048	0.025
26	2.17	0.13	0.072	(0.085)	0.048	0.025
27	2.25	0.13	0.072	(0.085)	0.048	0.025
28	2.33	0.13	0.072	(0.085)	0.048	0.025
29	2.42	0.13	0.072	(0.084)	0.048	0.025
30	2.50	0.13	0.072	(0.084)	0.048	0.025
31	2.58	0.17	0.090	(0.084)	0.060	0.031
32	2.67	0.17	0.090	(0.083)	0.060	0.031
33	2.75	0.17	0.090	(0.083)	0.060	0.031
34	2.83	0.17	0.090	(0.083)	0.060	0.031
35	2.92	0.17	0.090	(0.082)	0.060	0.031
36	3.00	0.17	0.090	(0.082)	0.060	0.031
37	3.08	0.17	0.090	(0.082)	0.060	0.031
38	3.17	0.17	0.090	(0.081)	0.060	0.031
39	3.25	0.17	0.090	(0.081)	0.060	0.031
40	3.33	0.17	0.090	(0.081)	0.060	0.031
41	3.42	0.17	0.090	(0.080)	0.060	0.031
42	3.50	0.17	0.090	(0.080)	0.060	0.031
43	3.58	0.17	0.090	(0.080)	0.060	0.031
44	3.67	0.17	0.090	(0.079)	0.060	0.031
45	3.75	0.17	0.090	(0.079)	0.060	0.031
46	3.83	0.20	0.108	(0.079)	0.072	0.037
47	3.92	0.20	0.108	(0.078)	0.072	0.037
48	4.00	0.20	0.108	(0.078)	0.072	0.037
49	4.08	0.20	0.108	(0.078)	0.072	0.037
50	4.17	0.20	0.108	(0.077)	0.072	0.037
51	4.25	0.20	0.108	(0.077)	0.072	0.037
52	4.33	0.23	0.127	0.077 (0.084)		0.050
53	4.42	0.23	0.127	0.076 (0.084)		0.050
54	4.50	0.23	0.127	0.076 (0.084)		0.051
55	4.58	0.23	0.127	0.076 (0.084)		0.051
56	4.67	0.23	0.127	0.075 (0.084)		0.051
57	4.75	0.23	0.127	0.075 (0.084)		0.052
58	4.83	0.27	0.145	0.075 (0.095)		0.070
59	4.92	0.27	0.145	0.074 (0.095)		0.070
60	5.00	0.27	0.145	0.074 (0.095)		0.071
61	5.08	0.20	0.108	(0.074)	0.072	0.037
62	5.17	0.20	0.108	(0.073)	0.072	0.037
63	5.25	0.20	0.108	(0.073)	0.072	0.037
64	5.33	0.23	0.127	0.073 (0.084)		0.054
65	5.42	0.23	0.127	0.072 (0.084)		0.054
66	5.50	0.23	0.127	0.072 (0.084)		0.055

67	5.58	0.27	0.145	0.072	(0.095)	0.073
68	5.67	0.27	0.145	0.071	(0.095)	0.073
69	5.75	0.27	0.145	0.071	(0.095)	0.074
70	5.83	0.27	0.145	0.071	(0.095)	0.074
71	5.92	0.27	0.145	0.070	(0.095)	0.074
72	6.00	0.27	0.145	0.070	(0.095)	0.074
73	6.08	0.30	0.163	0.070	(0.107)	0.093
74	6.17	0.30	0.163	0.070	(0.107)	0.093
75	6.25	0.30	0.163	0.069	(0.107)	0.093
76	6.33	0.30	0.163	0.069	(0.107)	0.094
77	6.42	0.30	0.163	0.069	(0.107)	0.094
78	6.50	0.30	0.163	0.068	(0.107)	0.094
79	6.58	0.33	0.181	0.068	(0.119)	0.113
80	6.67	0.33	0.181	0.068	(0.119)	0.113
81	6.75	0.33	0.181	0.067	(0.119)	0.113
82	6.83	0.33	0.181	0.067	(0.119)	0.114
83	6.92	0.33	0.181	0.067	(0.119)	0.114
84	7.00	0.33	0.181	0.066	(0.119)	0.114
85	7.08	0.33	0.181	0.066	(0.119)	0.115
86	7.17	0.33	0.181	0.066	(0.119)	0.115
87	7.25	0.33	0.181	0.066	(0.119)	0.115
88	7.33	0.37	0.199	0.065	(0.131)	0.134
89	7.42	0.37	0.199	0.065	(0.131)	0.134
90	7.50	0.37	0.199	0.065	(0.131)	0.134
91	7.58	0.40	0.217	0.064	(0.143)	0.153
92	7.67	0.40	0.217	0.064	(0.143)	0.153
93	7.75	0.40	0.217	0.064	(0.143)	0.153
94	7.83	0.43	0.235	0.063	(0.155)	0.172
95	7.92	0.43	0.235	0.063	(0.155)	0.172
96	8.00	0.43	0.235	0.063	(0.155)	0.172
97	8.08	0.50	0.271	0.063	(0.179)	0.209
98	8.17	0.50	0.271	0.062	(0.179)	0.209
99	8.25	0.50	0.271	0.062	(0.179)	0.209
100	8.33	0.50	0.271	0.062	(0.179)	0.209
101	8.42	0.50	0.271	0.061	(0.179)	0.210
102	8.50	0.50	0.271	0.061	(0.179)	0.210
103	8.58	0.53	0.289	0.061	(0.191)	0.228
104	8.67	0.53	0.289	0.061	(0.191)	0.229
105	8.75	0.53	0.289	0.060	(0.191)	0.229
106	8.83	0.57	0.307	0.060	(0.203)	0.247
107	8.92	0.57	0.307	0.060	(0.203)	0.248
108	9.00	0.57	0.307	0.059	(0.203)	0.248
109	9.08	0.63	0.343	0.059	(0.227)	0.284
110	9.17	0.63	0.343	0.059	(0.227)	0.285
111	9.25	0.63	0.343	0.059	(0.227)	0.285
112	9.33	0.67	0.362	0.058	(0.239)	0.303
113	9.42	0.67	0.362	0.058	(0.239)	0.304
114	9.50	0.67	0.362	0.058	(0.239)	0.304
115	9.58	0.70	0.380	0.057	(0.251)	0.322
116	9.67	0.70	0.380	0.057	(0.251)	0.322
117	9.75	0.70	0.380	0.057	(0.251)	0.323
118	9.83	0.73	0.398	0.057	(0.262)	0.341
119	9.92	0.73	0.398	0.056	(0.262)	0.341
120	10.00	0.73	0.398	0.056	(0.262)	0.342
121	10.08	0.50	0.271	0.056	(0.179)	0.215
122	10.17	0.50	0.271	0.056	(0.179)	0.216
123	10.25	0.50	0.271	0.055	(0.179)	0.216
124	10.33	0.50	0.271	0.055	(0.179)	0.216
125	10.42	0.50	0.271	0.055	(0.179)	0.216
126	10.50	0.50	0.271	0.055	(0.179)	0.217

127	10.58	0.67	0.362	0.054	(0.239)	0.307
128	10.67	0.67	0.362	0.054	(0.239)	0.308
129	10.75	0.67	0.362	0.054	(0.239)	0.308
130	10.83	0.67	0.362	0.053	(0.239)	0.308
131	10.92	0.67	0.362	0.053	(0.239)	0.308
132	11.00	0.67	0.362	0.053	(0.239)	0.309
133	11.08	0.63	0.343	0.053	(0.227)	0.291
134	11.17	0.63	0.343	0.052	(0.227)	0.291
135	11.25	0.63	0.343	0.052	(0.227)	0.291
136	11.33	0.63	0.343	0.052	(0.227)	0.292
137	11.42	0.63	0.343	0.052	(0.227)	0.292
138	11.50	0.63	0.343	0.051	(0.227)	0.292
139	11.58	0.57	0.307	0.051	(0.203)	0.256
140	11.67	0.57	0.307	0.051	(0.203)	0.256
141	11.75	0.57	0.307	0.051	(0.203)	0.257
142	11.83	0.60	0.325	0.050	(0.215)	0.275
143	11.92	0.60	0.325	0.050	(0.215)	0.275
144	12.00	0.60	0.325	0.050	(0.215)	0.276
145	12.08	0.83	0.452	0.050	(0.298)	0.402
146	12.17	0.83	0.452	0.049	(0.298)	0.403
147	12.25	0.83	0.452	0.049	(0.298)	0.403
148	12.33	0.87	0.470	0.049	(0.310)	0.421
149	12.42	0.87	0.470	0.049	(0.310)	0.421
150	12.50	0.87	0.470	0.048	(0.310)	0.422
151	12.58	0.93	0.506	0.048	(0.334)	0.458
152	12.67	0.93	0.506	0.048	(0.334)	0.458
153	12.75	0.93	0.506	0.048	(0.334)	0.459
154	12.83	0.97	0.524	0.047	(0.346)	0.477
155	12.92	0.97	0.524	0.047	(0.346)	0.477
156	13.00	0.97	0.524	0.047	(0.346)	0.477
157	13.08	1.13	0.615	0.047	(0.406)	0.568
158	13.17	1.13	0.615	0.046	(0.406)	0.568
159	13.25	1.13	0.615	0.046	(0.406)	0.568
160	13.33	1.13	0.615	0.046	(0.406)	0.569
161	13.42	1.13	0.615	0.046	(0.406)	0.569
162	13.50	1.13	0.615	0.046	(0.406)	0.569
163	13.58	0.77	0.416	0.045	(0.274)	0.371
164	13.67	0.77	0.416	0.045	(0.274)	0.371
165	13.75	0.77	0.416	0.045	(0.274)	0.371
166	13.83	0.77	0.416	0.045	(0.274)	0.371
167	13.92	0.77	0.416	0.044	(0.274)	0.371
168	14.00	0.77	0.416	0.044	(0.274)	0.372
169	14.08	0.90	0.488	0.044	(0.322)	0.444
170	14.17	0.90	0.488	0.044	(0.322)	0.444
171	14.25	0.90	0.488	0.043	(0.322)	0.445
172	14.33	0.87	0.470	0.043	(0.310)	0.427
173	14.42	0.87	0.470	0.043	(0.310)	0.427
174	14.50	0.87	0.470	0.043	(0.310)	0.427
175	14.58	0.87	0.470	0.043	(0.310)	0.427
176	14.67	0.87	0.470	0.042	(0.310)	0.428
177	14.75	0.87	0.470	0.042	(0.310)	0.428
178	14.83	0.83	0.452	0.042	(0.298)	0.410
179	14.92	0.83	0.452	0.042	(0.298)	0.410
180	15.00	0.83	0.452	0.042	(0.298)	0.410
181	15.08	0.80	0.434	0.041	(0.286)	0.393
182	15.17	0.80	0.434	0.041	(0.286)	0.393
183	15.25	0.80	0.434	0.041	(0.286)	0.393
184	15.33	0.77	0.416	0.041	(0.274)	0.375
185	15.42	0.77	0.416	0.040	(0.274)	0.375
186	15.50	0.77	0.416	0.040	(0.274)	0.376

187	15.58	0.63	0.343	0.040	(0.227)	0.303
188	15.67	0.63	0.343	0.040	(0.227)	0.304
189	15.75	0.63	0.343	0.040	(0.227)	0.304
190	15.83	0.63	0.343	0.039	(0.227)	0.304
191	15.92	0.63	0.343	0.039	(0.227)	0.304
192	16.00	0.63	0.343	0.039	(0.227)	0.304
193	16.08	0.13	0.072	0.039	(0.048)	0.033
194	16.17	0.13	0.072	0.039	(0.048)	0.034
195	16.25	0.13	0.072	0.038	(0.048)	0.034
196	16.33	0.13	0.072	0.038	(0.048)	0.034
197	16.42	0.13	0.072	0.038	(0.048)	0.034
198	16.50	0.13	0.072	0.038	(0.048)	0.034
199	16.58	0.10	0.054	(0.038)	0.036	0.018
200	16.67	0.10	0.054	(0.037)	0.036	0.018
201	16.75	0.10	0.054	(0.037)	0.036	0.018
202	16.83	0.10	0.054	(0.037)	0.036	0.018
203	16.92	0.10	0.054	(0.037)	0.036	0.018
204	17.00	0.10	0.054	(0.037)	0.036	0.018
205	17.08	0.17	0.090	0.037	(0.060)	0.054
206	17.17	0.17	0.090	0.036	(0.060)	0.054
207	17.25	0.17	0.090	0.036	(0.060)	0.054
208	17.33	0.17	0.090	0.036	(0.060)	0.054
209	17.42	0.17	0.090	0.036	(0.060)	0.055
210	17.50	0.17	0.090	0.036	(0.060)	0.055
211	17.58	0.17	0.090	0.035	(0.060)	0.055
212	17.67	0.17	0.090	0.035	(0.060)	0.055
213	17.75	0.17	0.090	0.035	(0.060)	0.055
214	17.83	0.13	0.072	0.035	(0.048)	0.037
215	17.92	0.13	0.072	0.035	(0.048)	0.038
216	18.00	0.13	0.072	0.035	(0.048)	0.038
217	18.08	0.13	0.072	0.034	(0.048)	0.038
218	18.17	0.13	0.072	0.034	(0.048)	0.038
219	18.25	0.13	0.072	0.034	(0.048)	0.038
220	18.33	0.13	0.072	0.034	(0.048)	0.038
221	18.42	0.13	0.072	0.034	(0.048)	0.039
222	18.50	0.13	0.072	0.034	(0.048)	0.039
223	18.58	0.10	0.054	0.033	(0.036)	0.021
224	18.67	0.10	0.054	0.033	(0.036)	0.021
225	18.75	0.10	0.054	0.033	(0.036)	0.021
226	18.83	0.07	0.036	(0.033)	0.024	0.012
227	18.92	0.07	0.036	(0.033)	0.024	0.012
228	19.00	0.07	0.036	(0.033)	0.024	0.012
229	19.08	0.10	0.054	0.032	(0.036)	0.022
230	19.17	0.10	0.054	0.032	(0.036)	0.022
231	19.25	0.10	0.054	0.032	(0.036)	0.022
232	19.33	0.13	0.072	0.032	(0.048)	0.040
233	19.42	0.13	0.072	0.032	(0.048)	0.040
234	19.50	0.13	0.072	0.032	(0.048)	0.041
235	19.58	0.10	0.054	0.032	(0.036)	0.023
236	19.67	0.10	0.054	0.031	(0.036)	0.023
237	19.75	0.10	0.054	0.031	(0.036)	0.023
238	19.83	0.07	0.036	(0.031)	0.024	0.012
239	19.92	0.07	0.036	(0.031)	0.024	0.012
240	20.00	0.07	0.036	(0.031)	0.024	0.012
241	20.08	0.10	0.054	0.031	(0.036)	0.024
242	20.17	0.10	0.054	0.031	(0.036)	0.024
243	20.25	0.10	0.054	0.030	(0.036)	0.024
244	20.33	0.10	0.054	0.030	(0.036)	0.024
245	20.42	0.10	0.054	0.030	(0.036)	0.024
246	20.50	0.10	0.054	0.030	(0.036)	0.024

247	20.58	0.10	0.054	0.030	(0.036)	0.024
248	20.67	0.10	0.054	0.030	(0.036)	0.024
249	20.75	0.10	0.054	0.030	(0.036)	0.025
250	20.83	0.07	0.036	(0.030)	0.024	0.012
251	20.92	0.07	0.036	(0.029)	0.024	0.012
252	21.00	0.07	0.036	(0.029)	0.024	0.012
253	21.08	0.10	0.054	0.029	(0.036)	0.025
254	21.17	0.10	0.054	0.029	(0.036)	0.025
255	21.25	0.10	0.054	0.029	(0.036)	0.025
256	21.33	0.07	0.036	(0.029)	0.024	0.012
257	21.42	0.07	0.036	(0.029)	0.024	0.012
258	21.50	0.07	0.036	(0.029)	0.024	0.012
259	21.58	0.10	0.054	0.029	(0.036)	0.026
260	21.67	0.10	0.054	0.028	(0.036)	0.026
261	21.75	0.10	0.054	0.028	(0.036)	0.026
262	21.83	0.07	0.036	(0.028)	0.024	0.012
263	21.92	0.07	0.036	(0.028)	0.024	0.012
264	22.00	0.07	0.036	(0.028)	0.024	0.012
265	22.08	0.10	0.054	0.028	(0.036)	0.026
266	22.17	0.10	0.054	0.028	(0.036)	0.026
267	22.25	0.10	0.054	0.028	(0.036)	0.026
268	22.33	0.07	0.036	(0.028)	0.024	0.012
269	22.42	0.07	0.036	(0.028)	0.024	0.012
270	22.50	0.07	0.036	(0.028)	0.024	0.012
271	22.58	0.07	0.036	(0.027)	0.024	0.012
272	22.67	0.07	0.036	(0.027)	0.024	0.012
273	22.75	0.07	0.036	(0.027)	0.024	0.012
274	22.83	0.07	0.036	(0.027)	0.024	0.012
275	22.92	0.07	0.036	(0.027)	0.024	0.012
276	23.00	0.07	0.036	(0.027)	0.024	0.012
277	23.08	0.07	0.036	(0.027)	0.024	0.012
278	23.17	0.07	0.036	(0.027)	0.024	0.012
279	23.25	0.07	0.036	(0.027)	0.024	0.012
280	23.33	0.07	0.036	(0.027)	0.024	0.012
281	23.42	0.07	0.036	(0.027)	0.024	0.012
282	23.50	0.07	0.036	(0.027)	0.024	0.012
283	23.58	0.07	0.036	(0.027)	0.024	0.012
284	23.67	0.07	0.036	(0.027)	0.024	0.012
285	23.75	0.07	0.036	(0.027)	0.024	0.012
286	23.83	0.07	0.036	(0.027)	0.024	0.012
287	23.92	0.07	0.036	(0.027)	0.024	0.012
288	24.00	0.07	0.036	(0.027)	0.024	0.012

(Loss Rate Not Used)

Sum = 100.0

Sum = 40.9

Flood volume = Effective rainfall 3.41 (In)
times area 51.6 (Ac.) / [(In) / (Ft.)] = 14.7 (Ac.Ft)
Total soil loss = 1.11 (In)
Total soil loss = 4.767 (Ac.Ft)
Total rainfall = 4.52 (In)
Flood volume = 639714.3 Cubic Feet
Total soil loss = 207652.8 Cubic Feet

Peak flow rate of this hydrograph = 29.111 (CFS)

++++
24 - H O U R S T O R M
R u n o f f H y d r o g r a p h

Hydrograph in 5 Minute intervals ((CFS))

Time (h+m)	Volume	Ac.Ft	Q(CFS)	0	7.5	15.0	22.5	30.0
0+ 5	0.0004		0.06	Q				
0+10	0.0024		0.29	Q				
0+15	0.0055		0.45	Q				
0+20	0.0093		0.54	Q				
0+25	0.0141		0.70	Q				
0+30	0.0196		0.80	VQ				
0+35	0.0255		0.85	VQ				
0+40	0.0316		0.89	VQ				
0+45	0.0378		0.91	VQ				
0+50	0.0444		0.95	VQ				
0+55	0.0518		1.08	VQ				
1+ 0	0.0599		1.17	VQ				
1+ 5	0.0681		1.18	VQ				
1+10	0.0755		1.09	VQ				
1+15	0.0826		1.02	VQ				
1+20	0.0895		1.00	VQ				
1+25	0.0963		0.99	VQ				
1+30	0.1030		0.98	VQ				
1+35	0.1097		0.98	VQ				
1+40	0.1164		0.97	VQ				
1+45	0.1231		0.97	VQ				
1+50	0.1300		1.00	VQ				
1+55	0.1376		1.11	VQ				
2+ 0	0.1458		1.19	VQ				
2+ 5	0.1542		1.22	VQ				
2+10	0.1627		1.24	VQ				
2+15	0.1713		1.25	VQ				
2+20	0.1800		1.26	VQ				
2+25	0.1887		1.26	VQ				
2+30	0.1974		1.27	VQ				
2+35	0.2064		1.30	VQ				
2+40	0.2162		1.42	VQ				
2+45	0.2266		1.50	V Q				
2+50	0.2371		1.54	V Q				
2+55	0.2479		1.56	V Q				
3+ 0	0.2587		1.57	V Q				
3+ 5	0.2695		1.58	V Q				
3+10	0.2805		1.58	V Q				
3+15	0.2914		1.59	V Q				
3+20	0.3024		1.59	V Q				
3+25	0.3134		1.60	V Q				
3+30	0.3244		1.60	V Q				
3+35	0.3354		1.60	V Q				
3+40	0.3464		1.60	V Q				
3+45	0.3575		1.60	V Q				
3+50	0.3687		1.63	VQ				
3+55	0.3807		1.75	VQ				
4+ 0	0.3933		1.83	VQ				
4+ 5	0.4061		1.86	VQ				
4+10	0.4190		1.88	VQ				
4+15	0.4320		1.89	VQ				
4+20	0.4455		1.96	VQ				
4+25	0.4608		2.22	VQ				
4+30	0.4773		2.40	V Q				
4+35	0.4944		2.49	V Q				
4+40	0.5120		2.54	V Q				
4+45	0.5298		2.59	V Q				

4+50	0.5484	2.71	V Q				
4+55	0.5696	3.08	V Q				
5+ 0	0.5926	3.34	V Q				
5+ 5	0.6153	3.30	V Q				
5+10	0.6342	2.73	V Q				
5+15	0.6502	2.33	V Q				
5+20	0.6658	2.27	V Q				
5+25	0.6831	2.51	V Q				
5+30	0.7017	2.69	V Q				
5+35	0.7212	2.84	V Q				
5+40	0.7434	3.22	V Q				
5+45	0.7674	3.49	V Q				
5+50	0.7922	3.60	V Q				
5+55	0.8175	3.68	V Q				
6+ 0	0.8432	3.73	V Q				
6+ 5	0.8698	3.86	V Q				
6+10	0.8990	4.24	V Q				
6+15	0.9301	4.52	V Q				
6+20	0.9621	4.64	V Q				
6+25	0.9946	4.72	V Q				
6+30	1.0275	4.78	V Q				
6+35	1.0614	4.91	V Q				
6+40	1.0978	5.29	V Q				
6+45	1.1361	5.56	V Q				
6+50	1.1753	5.68	V Q				
6+55	1.2149	5.76	V Q				
7+ 0	1.2550	5.82	V Q				
7+ 5	1.2954	5.87	V Q				
7+10	1.3360	5.90	V Q				
7+15	1.3769	5.93	V Q				
7+20	1.4185	6.04	V Q				
7+25	1.4627	6.41	V Q				
7+30	1.5086	6.67	V Q				
7+35	1.5559	6.87	V Q				
7+40	1.6060	7.28	V Q				
7+45	1.6582	7.57	V Q				
7+50	1.7119	7.79	V Q				
7+55	1.7685	8.22	V Q				
8+ 0	1.8272	8.53	V Q				
8+ 5	1.8881	8.84	V Q				
8+10	1.9544	9.62	V Q				
8+15	2.0245	10.18	V Q				
8+20	2.0963	10.42	V Q				
8+25	2.1691	10.57	V Q				
8+30	2.2426	10.68	V Q				
8+35	2.3174	10.85	V Q				
8+40	2.3949	11.25	V Q				
8+45	2.4744	11.54	V Q				
8+50	2.5554	11.76	V Q				
8+55	2.6393	12.19	V Q				
9+ 0	2.7254	12.49	V Q				
9+ 5	2.8136	12.81	V Q				
9+10	2.9072	13.58	V Q				
9+15	3.0045	14.13	V Q				
9+20	3.1040	14.45	V Q				
9+25	3.2069	14.94	V Q				
9+30	3.3122	15.29	V Q				
9+35	3.4193	15.55	V Q				
9+40	3.5295	16.01	V Q				
9+45	3.6420	16.34	V Q				

9+50	3.7562	16.58		V		Q			
9+55	3.8735	17.03		V		Q			
10+ 0	3.9930	17.35		V		Q			
10+ 5	4.1094	16.91		V		Q			
10+10	4.2100	14.61		V		Q			
10+15	4.2996	13.01		V		Q			
10+20	4.3852	12.42		V		Q			
10+25	4.4684	12.08		V		Q			
10+30	4.5500	11.85		V		Q			
10+35	4.6335	12.13		V		Q			
10+40	4.7280	13.72		V		Q			
10+45	4.8302	14.84		V		Q			
10+50	4.9351	15.24		V		Q			
10+55	5.0417	15.48		V		Q			
11+ 0	5.1494	15.63		V		Q			
11+ 5	5.2571	15.64		V		Q			
11+10	5.3633	15.41		V		Q			
11+15	5.4683	15.26		V		Q			
11+20	5.5733	15.24		V		Q			
11+25	5.6782	15.23		V		Q			
11+30	5.7831	15.24		V		Q			
11+35	5.8871	15.09		V		Q			
11+40	5.9862	14.40		V		Q			
11+45	6.0821	13.92		V		Q			
11+50	6.1773	13.82		V		Q			
11+55	6.2742	14.06		VQ					
12+ 0	6.3722	14.23		VQ					
12+ 5	6.4746	14.87		V		Q			
12+10	6.5937	17.30		V		Q			
12+15	6.7245	18.99		V		Q			
12+20	6.8605	19.74		V		Q			
12+25	7.0015	20.48		V		Q			
12+30	7.1462	21.00		V		Q			
12+35	7.2939	21.45		V		Q			
12+40	7.4478	22.34		V		Q			
12+45	7.6060	22.98		V		Q			
12+50	7.7670	23.37		V		Q			
12+55	7.9317	23.91		V		Q			
13+ 0	8.0990	24.29		V		Q			
13+ 5	8.2707	24.93		V		Q			
13+10	8.4549	26.75		V		Q			
13+15	8.6480	28.04		V		Q			
13+20	8.8447	28.56		V		Q			
13+25	9.0437	28.89		V		Q			
13+30	9.2442	29.11		V		Q			
13+35	9.4394	28.34		V		Q			
13+40	9.6095	24.70		V		Q			
13+45	9.7621	22.16		V		Q			
13+50	9.9083	21.22		V		Q			
13+55	10.0506	20.66		V		Q			
14+ 0	10.1904	20.30		V		Q			
14+ 5	10.3308	20.40		V		Q			
14+10	10.4794	21.57		V		Q			
14+15	10.6335	22.37		VQ					
14+20	10.7888	22.55		VQ					
14+25	10.9427	22.35		VQ					
14+30	11.0956	22.21		VQ					
14+35	11.2482	22.16		VQ					
14+40	11.4010	22.19		VQ					
14+45	11.5541	22.22		VQ					

19+50	14.3662	1.24	Q					V
19+55	14.3732	1.01	Q					V
20+ 0	14.3790	0.85	Q					V
20+ 5	14.3848	0.84	Q					V
20+10	14.3918	1.01	Q					V
20+15	14.3996	1.13	Q					V
20+20	14.4077	1.18	Q					V
20+25	14.4160	1.20	Q					V
20+30	14.4243	1.21	Q					V
20+35	14.4328	1.22	Q					V
20+40	14.4413	1.24	Q					V
20+45	14.4499	1.25	Q					V
20+50	14.4581	1.20	Q					V
20+55	14.4648	0.98	Q					V
21+ 0	14.4705	0.82	Q					V
21+ 5	14.4761	0.82	Q					V
21+10	14.4832	1.03	Q					V
21+15	14.4913	1.17	Q					V
21+20	14.4993	1.16	Q					V
21+25	14.5058	0.95	Q					V
21+30	14.5113	0.79	Q					V
21+35	14.5168	0.80	Q					V
21+40	14.5238	1.02	Q					V
21+45	14.5320	1.18	Q					V
21+50	14.5401	1.18	Q					V
21+55	14.5466	0.95	Q					V
22+ 0	14.5521	0.80	Q					V
22+ 5	14.5577	0.81	Q					V
22+10	14.5649	1.04	Q					V
22+15	14.5732	1.21	Q					V
22+20	14.5814	1.20	Q					V
22+25	14.5881	0.97	Q					V
22+30	14.5936	0.80	Q					V
22+35	14.5988	0.75	Q					V
22+40	14.6037	0.71	Q					V
22+45	14.6085	0.69	Q					V
22+50	14.6131	0.68	Q					V
22+55	14.6177	0.67	Q					V
23+ 0	14.6222	0.66	Q					V
23+ 5	14.6268	0.66	Q					V
23+10	14.6312	0.65	Q					V
23+15	14.6357	0.65	Q					V
23+20	14.6401	0.64	Q					V
23+25	14.6445	0.64	Q					V
23+30	14.6489	0.64	Q					V
23+35	14.6533	0.64	Q					V
23+40	14.6577	0.64	Q					V
23+45	14.6621	0.64	Q					V
23+50	14.6665	0.64	Q					V
23+55	14.6709	0.64	Q					V
24+ 0	14.6754	0.64	Q					V
24+ 5	14.6794	0.58	Q					V
24+10	14.6818	0.35	Q					V
24+15	14.6831	0.19	Q					V
24+20	14.6839	0.12	Q					V
24+25	14.6845	0.09	Q					V
24+30	14.6850	0.06	Q					V
24+35	14.6853	0.04	Q					V
24+40	14.6855	0.03	Q					V
24+45	14.6856	0.02	Q					V

24+50	14.6857	0.01	Q				V
24+55	14.6858	0.01	Q				V
25+ 0	14.6858	0.00	Q				V

**PRELIMINARY DRAINAGE ANALYSIS
OLD 215 INDUSTRIAL BUILDING (PEN21-0325 / LST22-0007)
CITY OF MORENO VALLEY, CA**

APPENDIX E.2

100-YEAR HYDROLOGY CALCULATIONS (AREA B2, EDGEMONT)

Unit Hydrograph Analysis

Copyright (c) CIVILCADD/CIVILDESIGN, 1989 - 2018, Version 9.0
Study date 03/17/22 File: 100B224100.out

+++++

Riverside County Synthetic Unit Hydrology Method
RCFC & WCD Manual date - April 1978

Program License Serial Number 6522

English (in-lb) Input Units Used
English Rainfall Data (Inches) Input Values Used

English Units used in output format

1494-0006 OLD 215 FRONTAGE ROAD
EXISTING CONDITION
100-YEAR, 24-HOUR STORM
OFF SITE, B2

Drainage Area = 36.13(Ac.) = 0.056 Sq. Mi.
Drainage Area for Depth-Area Areal Adjustment = 36.13(Ac.) = 0.056
Sq. Mi.
Length along longest watercourse = 1570.00(Ft.)
Length along longest watercourse measured to centroid = 832.00(Ft.)
Length along longest watercourse = 0.297 Mi.
Length along longest watercourse measured to centroid = 0.158 Mi.
Difference in elevation = 25.80(Ft.)
Slope along watercourse = 86.7669 Ft./Mi.
Average Manning's 'N' = 0.025
Lag time = 0.080 Hr.
Lag time = 4.82 Min.
25% of lag time = 1.20 Min.
40% of lag time = 1.93 Min.
Unit time = 5.00 Min.
Duration of storm = 24 Hour(s)
User Entered Base Flow = 0.00(CFS)

2 YEAR Area rainfall data:

Area(Ac.) [1]	Rainfall(In) [2]	Weighting[1*2]
36.13	1.85	66.84

100 YEAR Area rainfall data:

Area(Ac.) [1]	Rainfall(In) [2]	Weighting[1*2]
36.13	4.52	163.31

STORM EVENT (YEAR) = 100.00
 Area Averaged 2-Year Rainfall = 1.850 (In)
 Area Averaged 100-Year Rainfall = 4.520 (In)

Point rain (area averaged) = 4.520 (In)
 Areal adjustment factor = 99.99 %
 Adjusted average point rain = 4.520 (In)

Sub-Area Data:

Area (Ac.) Runoff Index Impervious %
 36.130 86.00 0.300
 Total Area Entered = 36.13 (Ac.)

RI	RI	Infil. Rate	Impervious	Adj. Infil. Rate	Area%	F
AMC2	AMC-3	(In/Hr)	(Dec.%)	(In/Hr)	(Dec.)	(In/Hr)
86.0	94.4	0.073	0.300	0.053	1.000	0.053
						Sum (F) = 0.053

Area averaged mean soil loss (F) (In/Hr) = 0.053
 Minimum soil loss rate ((In/Hr)) = 0.027
 (for 24 hour storm duration)
 Soil low loss rate (decimal) = 0.660

 U n i t H y d r o g r a p h
 VALLEY S-Curve

Unit Hydrograph Data

Unit time period (hrs)	Time % of lag	Distribution Graph %	Unit Hydrograph (CFS)
1	0.083	103.769	7.412
2	0.167	207.538	17.711
3	0.250	311.307	5.496
4	0.333	415.076	2.500
5	0.417	518.845	1.395
6	0.500	622.614	0.896
7	0.583	726.383	0.541
8	0.667	830.152	0.462
		Sum = 100.000	Sum= 36.412

The following loss rate calculations reflect use of the minimum calculated loss rate subtracted from the Storm Rain to produce the maximum Effective Rain value

Unit	Time (Hr.)	Pattern Percent	Storm Rain (In/Hr)	Loss rate (In./Hr)		Effective (In/Hr)
				Max	Low	
1	0.08	0.07	0.036	(0.094)	0.024	0.012
2	0.17	0.07	0.036	(0.094)	0.024	0.012
3	0.25	0.07	0.036	(0.093)	0.024	0.012
4	0.33	0.10	0.054	(0.093)	0.036	0.018
5	0.42	0.10	0.054	(0.093)	0.036	0.018
6	0.50	0.10	0.054	(0.092)	0.036	0.018
7	0.58	0.10	0.054	(0.092)	0.036	0.018
8	0.67	0.10	0.054	(0.092)	0.036	0.018
9	0.75	0.10	0.054	(0.091)	0.036	0.018
10	0.83	0.13	0.072	(0.091)	0.048	0.025
11	0.92	0.13	0.072	(0.091)	0.048	0.025

12	1.00	0.13	0.072	(0.090)	0.048	0.025
13	1.08	0.10	0.054	(0.090)	0.036	0.018
14	1.17	0.10	0.054	(0.090)	0.036	0.018
15	1.25	0.10	0.054	(0.089)	0.036	0.018
16	1.33	0.10	0.054	(0.089)	0.036	0.018
17	1.42	0.10	0.054	(0.088)	0.036	0.018
18	1.50	0.10	0.054	(0.088)	0.036	0.018
19	1.58	0.10	0.054	(0.088)	0.036	0.018
20	1.67	0.10	0.054	(0.087)	0.036	0.018
21	1.75	0.10	0.054	(0.087)	0.036	0.018
22	1.83	0.13	0.072	(0.087)	0.048	0.025
23	1.92	0.13	0.072	(0.086)	0.048	0.025
24	2.00	0.13	0.072	(0.086)	0.048	0.025
25	2.08	0.13	0.072	(0.086)	0.048	0.025
26	2.17	0.13	0.072	(0.085)	0.048	0.025
27	2.25	0.13	0.072	(0.085)	0.048	0.025
28	2.33	0.13	0.072	(0.085)	0.048	0.025
29	2.42	0.13	0.072	(0.084)	0.048	0.025
30	2.50	0.13	0.072	(0.084)	0.048	0.025
31	2.58	0.17	0.090	(0.084)	0.060	0.031
32	2.67	0.17	0.090	(0.083)	0.060	0.031
33	2.75	0.17	0.090	(0.083)	0.060	0.031
34	2.83	0.17	0.090	(0.083)	0.060	0.031
35	2.92	0.17	0.090	(0.082)	0.060	0.031
36	3.00	0.17	0.090	(0.082)	0.060	0.031
37	3.08	0.17	0.090	(0.082)	0.060	0.031
38	3.17	0.17	0.090	(0.081)	0.060	0.031
39	3.25	0.17	0.090	(0.081)	0.060	0.031
40	3.33	0.17	0.090	(0.081)	0.060	0.031
41	3.42	0.17	0.090	(0.080)	0.060	0.031
42	3.50	0.17	0.090	(0.080)	0.060	0.031
43	3.58	0.17	0.090	(0.080)	0.060	0.031
44	3.67	0.17	0.090	(0.079)	0.060	0.031
45	3.75	0.17	0.090	(0.079)	0.060	0.031
46	3.83	0.20	0.108	(0.079)	0.072	0.037
47	3.92	0.20	0.108	(0.078)	0.072	0.037
48	4.00	0.20	0.108	(0.078)	0.072	0.037
49	4.08	0.20	0.108	(0.078)	0.072	0.037
50	4.17	0.20	0.108	(0.077)	0.072	0.037
51	4.25	0.20	0.108	(0.077)	0.072	0.037
52	4.33	0.23	0.127	0.077 (0.084)		0.050
53	4.42	0.23	0.127	0.076 (0.084)		0.050
54	4.50	0.23	0.127	0.076 (0.084)		0.051
55	4.58	0.23	0.127	0.076 (0.084)		0.051
56	4.67	0.23	0.127	0.075 (0.084)		0.051
57	4.75	0.23	0.127	0.075 (0.084)		0.052
58	4.83	0.27	0.145	0.075 (0.095)		0.070
59	4.92	0.27	0.145	0.074 (0.095)		0.070
60	5.00	0.27	0.145	0.074 (0.095)		0.071
61	5.08	0.20	0.108	(0.074)	0.072	0.037
62	5.17	0.20	0.108	(0.073)	0.072	0.037
63	5.25	0.20	0.108	(0.073)	0.072	0.037
64	5.33	0.23	0.127	0.073 (0.084)		0.054
65	5.42	0.23	0.127	0.072 (0.084)		0.054
66	5.50	0.23	0.127	0.072 (0.084)		0.055
67	5.58	0.27	0.145	0.072 (0.095)		0.073
68	5.67	0.27	0.145	0.071 (0.095)		0.073
69	5.75	0.27	0.145	0.071 (0.095)		0.074
70	5.83	0.27	0.145	0.071 (0.095)		0.074
71	5.92	0.27	0.145	0.070 (0.095)		0.074

72	6.00	0.27	0.145	0.070	(0.095)	0.074
73	6.08	0.30	0.163	0.070	(0.107)	0.093
74	6.17	0.30	0.163	0.070	(0.107)	0.093
75	6.25	0.30	0.163	0.069	(0.107)	0.093
76	6.33	0.30	0.163	0.069	(0.107)	0.094
77	6.42	0.30	0.163	0.069	(0.107)	0.094
78	6.50	0.30	0.163	0.068	(0.107)	0.094
79	6.58	0.33	0.181	0.068	(0.119)	0.113
80	6.67	0.33	0.181	0.068	(0.119)	0.113
81	6.75	0.33	0.181	0.067	(0.119)	0.113
82	6.83	0.33	0.181	0.067	(0.119)	0.114
83	6.92	0.33	0.181	0.067	(0.119)	0.114
84	7.00	0.33	0.181	0.066	(0.119)	0.114
85	7.08	0.33	0.181	0.066	(0.119)	0.115
86	7.17	0.33	0.181	0.066	(0.119)	0.115
87	7.25	0.33	0.181	0.066	(0.119)	0.115
88	7.33	0.37	0.199	0.065	(0.131)	0.134
89	7.42	0.37	0.199	0.065	(0.131)	0.134
90	7.50	0.37	0.199	0.065	(0.131)	0.134
91	7.58	0.40	0.217	0.064	(0.143)	0.153
92	7.67	0.40	0.217	0.064	(0.143)	0.153
93	7.75	0.40	0.217	0.064	(0.143)	0.153
94	7.83	0.43	0.235	0.063	(0.155)	0.172
95	7.92	0.43	0.235	0.063	(0.155)	0.172
96	8.00	0.43	0.235	0.063	(0.155)	0.172
97	8.08	0.50	0.271	0.063	(0.179)	0.209
98	8.17	0.50	0.271	0.062	(0.179)	0.209
99	8.25	0.50	0.271	0.062	(0.179)	0.209
100	8.33	0.50	0.271	0.062	(0.179)	0.209
101	8.42	0.50	0.271	0.061	(0.179)	0.210
102	8.50	0.50	0.271	0.061	(0.179)	0.210
103	8.58	0.53	0.289	0.061	(0.191)	0.228
104	8.67	0.53	0.289	0.061	(0.191)	0.229
105	8.75	0.53	0.289	0.060	(0.191)	0.229
106	8.83	0.57	0.307	0.060	(0.203)	0.247
107	8.92	0.57	0.307	0.060	(0.203)	0.248
108	9.00	0.57	0.307	0.059	(0.203)	0.248
109	9.08	0.63	0.343	0.059	(0.227)	0.284
110	9.17	0.63	0.343	0.059	(0.227)	0.285
111	9.25	0.63	0.343	0.059	(0.227)	0.285
112	9.33	0.67	0.362	0.058	(0.239)	0.303
113	9.42	0.67	0.362	0.058	(0.239)	0.304
114	9.50	0.67	0.362	0.058	(0.239)	0.304
115	9.58	0.70	0.380	0.057	(0.251)	0.322
116	9.67	0.70	0.380	0.057	(0.251)	0.322
117	9.75	0.70	0.380	0.057	(0.251)	0.323
118	9.83	0.73	0.398	0.057	(0.263)	0.341
119	9.92	0.73	0.398	0.056	(0.263)	0.341
120	10.00	0.73	0.398	0.056	(0.263)	0.342
121	10.08	0.50	0.271	0.056	(0.179)	0.215
122	10.17	0.50	0.271	0.056	(0.179)	0.216
123	10.25	0.50	0.271	0.055	(0.179)	0.216
124	10.33	0.50	0.271	0.055	(0.179)	0.216
125	10.42	0.50	0.271	0.055	(0.179)	0.216
126	10.50	0.50	0.271	0.055	(0.179)	0.217
127	10.58	0.67	0.362	0.054	(0.239)	0.307
128	10.67	0.67	0.362	0.054	(0.239)	0.308
129	10.75	0.67	0.362	0.054	(0.239)	0.308
130	10.83	0.67	0.362	0.053	(0.239)	0.308
131	10.92	0.67	0.362	0.053	(0.239)	0.308

132	11.00	0.67	0.362	0.053	(0.239)	0.309
133	11.08	0.63	0.343	0.053	(0.227)	0.291
134	11.17	0.63	0.343	0.052	(0.227)	0.291
135	11.25	0.63	0.343	0.052	(0.227)	0.291
136	11.33	0.63	0.343	0.052	(0.227)	0.292
137	11.42	0.63	0.343	0.052	(0.227)	0.292
138	11.50	0.63	0.343	0.051	(0.227)	0.292
139	11.58	0.57	0.307	0.051	(0.203)	0.256
140	11.67	0.57	0.307	0.051	(0.203)	0.256
141	11.75	0.57	0.307	0.051	(0.203)	0.257
142	11.83	0.60	0.325	0.050	(0.215)	0.275
143	11.92	0.60	0.325	0.050	(0.215)	0.275
144	12.00	0.60	0.325	0.050	(0.215)	0.276
145	12.08	0.83	0.452	0.050	(0.298)	0.402
146	12.17	0.83	0.452	0.049	(0.298)	0.403
147	12.25	0.83	0.452	0.049	(0.298)	0.403
148	12.33	0.87	0.470	0.049	(0.310)	0.421
149	12.42	0.87	0.470	0.049	(0.310)	0.421
150	12.50	0.87	0.470	0.048	(0.310)	0.422
151	12.58	0.93	0.506	0.048	(0.334)	0.458
152	12.67	0.93	0.506	0.048	(0.334)	0.458
153	12.75	0.93	0.506	0.048	(0.334)	0.459
154	12.83	0.97	0.524	0.047	(0.346)	0.477
155	12.92	0.97	0.524	0.047	(0.346)	0.477
156	13.00	0.97	0.524	0.047	(0.346)	0.477
157	13.08	1.13	0.615	0.047	(0.406)	0.568
158	13.17	1.13	0.615	0.046	(0.406)	0.568
159	13.25	1.13	0.615	0.046	(0.406)	0.568
160	13.33	1.13	0.615	0.046	(0.406)	0.569
161	13.42	1.13	0.615	0.046	(0.406)	0.569
162	13.50	1.13	0.615	0.046	(0.406)	0.569
163	13.58	0.77	0.416	0.045	(0.274)	0.371
164	13.67	0.77	0.416	0.045	(0.274)	0.371
165	13.75	0.77	0.416	0.045	(0.274)	0.371
166	13.83	0.77	0.416	0.045	(0.274)	0.371
167	13.92	0.77	0.416	0.044	(0.274)	0.371
168	14.00	0.77	0.416	0.044	(0.274)	0.372
169	14.08	0.90	0.488	0.044	(0.322)	0.444
170	14.17	0.90	0.488	0.044	(0.322)	0.444
171	14.25	0.90	0.488	0.043	(0.322)	0.445
172	14.33	0.87	0.470	0.043	(0.310)	0.427
173	14.42	0.87	0.470	0.043	(0.310)	0.427
174	14.50	0.87	0.470	0.043	(0.310)	0.427
175	14.58	0.87	0.470	0.043	(0.310)	0.427
176	14.67	0.87	0.470	0.042	(0.310)	0.428
177	14.75	0.87	0.470	0.042	(0.310)	0.428
178	14.83	0.83	0.452	0.042	(0.298)	0.410
179	14.92	0.83	0.452	0.042	(0.298)	0.410
180	15.00	0.83	0.452	0.042	(0.298)	0.410
181	15.08	0.80	0.434	0.041	(0.286)	0.393
182	15.17	0.80	0.434	0.041	(0.286)	0.393
183	15.25	0.80	0.434	0.041	(0.286)	0.393
184	15.33	0.77	0.416	0.041	(0.274)	0.375
185	15.42	0.77	0.416	0.040	(0.274)	0.375
186	15.50	0.77	0.416	0.040	(0.274)	0.376
187	15.58	0.63	0.343	0.040	(0.227)	0.303
188	15.67	0.63	0.343	0.040	(0.227)	0.304
189	15.75	0.63	0.343	0.040	(0.227)	0.304
190	15.83	0.63	0.343	0.039	(0.227)	0.304
191	15.92	0.63	0.343	0.039	(0.227)	0.304

192	16.00	0.63	0.343		0.039	(0.227)	0.304
193	16.08	0.13	0.072		0.039	(0.048)	0.033
194	16.17	0.13	0.072		0.039	(0.048)	0.034
195	16.25	0.13	0.072		0.038	(0.048)	0.034
196	16.33	0.13	0.072		0.038	(0.048)	0.034
197	16.42	0.13	0.072		0.038	(0.048)	0.034
198	16.50	0.13	0.072		0.038	(0.048)	0.034
199	16.58	0.10	0.054	(0.038)		0.036	0.018
200	16.67	0.10	0.054	(0.037)		0.036	0.018
201	16.75	0.10	0.054	(0.037)		0.036	0.018
202	16.83	0.10	0.054	(0.037)		0.036	0.018
203	16.92	0.10	0.054	(0.037)		0.036	0.018
204	17.00	0.10	0.054	(0.037)		0.036	0.018
205	17.08	0.17	0.090		0.037	(0.060)	0.054
206	17.17	0.17	0.090		0.036	(0.060)	0.054
207	17.25	0.17	0.090		0.036	(0.060)	0.054
208	17.33	0.17	0.090		0.036	(0.060)	0.054
209	17.42	0.17	0.090		0.036	(0.060)	0.055
210	17.50	0.17	0.090		0.036	(0.060)	0.055
211	17.58	0.17	0.090		0.035	(0.060)	0.055
212	17.67	0.17	0.090		0.035	(0.060)	0.055
213	17.75	0.17	0.090		0.035	(0.060)	0.055
214	17.83	0.13	0.072		0.035	(0.048)	0.037
215	17.92	0.13	0.072		0.035	(0.048)	0.038
216	18.00	0.13	0.072		0.035	(0.048)	0.038
217	18.08	0.13	0.072		0.034	(0.048)	0.038
218	18.17	0.13	0.072		0.034	(0.048)	0.038
219	18.25	0.13	0.072		0.034	(0.048)	0.038
220	18.33	0.13	0.072		0.034	(0.048)	0.038
221	18.42	0.13	0.072		0.034	(0.048)	0.039
222	18.50	0.13	0.072		0.034	(0.048)	0.039
223	18.58	0.10	0.054		0.033	(0.036)	0.021
224	18.67	0.10	0.054		0.033	(0.036)	0.021
225	18.75	0.10	0.054		0.033	(0.036)	0.021
226	18.83	0.07	0.036	(0.033)		0.024	0.012
227	18.92	0.07	0.036	(0.033)		0.024	0.012
228	19.00	0.07	0.036	(0.033)		0.024	0.012
229	19.08	0.10	0.054		0.032	(0.036)	0.022
230	19.17	0.10	0.054		0.032	(0.036)	0.022
231	19.25	0.10	0.054		0.032	(0.036)	0.022
232	19.33	0.13	0.072		0.032	(0.048)	0.040
233	19.42	0.13	0.072		0.032	(0.048)	0.040
234	19.50	0.13	0.072		0.032	(0.048)	0.041
235	19.58	0.10	0.054		0.032	(0.036)	0.023
236	19.67	0.10	0.054		0.031	(0.036)	0.023
237	19.75	0.10	0.054		0.031	(0.036)	0.023
238	19.83	0.07	0.036	(0.031)		0.024	0.012
239	19.92	0.07	0.036	(0.031)		0.024	0.012
240	20.00	0.07	0.036	(0.031)		0.024	0.012
241	20.08	0.10	0.054		0.031	(0.036)	0.024
242	20.17	0.10	0.054		0.031	(0.036)	0.024
243	20.25	0.10	0.054		0.030	(0.036)	0.024
244	20.33	0.10	0.054		0.030	(0.036)	0.024
245	20.42	0.10	0.054		0.030	(0.036)	0.024
246	20.50	0.10	0.054		0.030	(0.036)	0.024
247	20.58	0.10	0.054		0.030	(0.036)	0.024
248	20.67	0.10	0.054		0.030	(0.036)	0.024
249	20.75	0.10	0.054		0.030	(0.036)	0.025
250	20.83	0.07	0.036	(0.030)		0.024	0.012
251	20.92	0.07	0.036	(0.029)		0.024	0.012

0+15	0.0053	0.38	Q				
0+20	0.0085	0.45	Q				
0+25	0.0125	0.58	Q				
0+30	0.0168	0.62	Q				
0+35	0.0212	0.65	Q				
0+40	0.0257	0.66	Q				
0+45	0.0303	0.67	Q				
0+50	0.0353	0.71	Q				
0+55	0.0409	0.83	VQ				
1+ 0	0.0469	0.86	VQ				
1+ 5	0.0526	0.83	VQ				
1+10	0.0576	0.73	Q				
1+15	0.0624	0.70	Q				
1+20	0.0672	0.69	Q				
1+25	0.0719	0.68	Q				
1+30	0.0766	0.68	Q				
1+35	0.0812	0.67	Q				
1+40	0.0858	0.67	Q				
1+45	0.0905	0.67	Q				
1+50	0.0954	0.72	Q				
1+55	0.1011	0.83	VQ				
2+ 0	0.1070	0.86	VQ				
2+ 5	0.1130	0.88	VQ				
2+10	0.1191	0.88	VQ				
2+15	0.1253	0.89	VQ				
2+20	0.1314	0.89	VQ				
2+25	0.1376	0.90	VQ				
2+30	0.1437	0.90	VQ				
2+35	0.1502	0.94	VQ				
2+40	0.1575	1.05	VQ				
2+45	0.1649	1.08	VQ				
2+50	0.1725	1.10	VQ				
2+55	0.1801	1.11	VQ				
3+ 0	0.1878	1.11	VQ				
3+ 5	0.1955	1.12	VQ				
3+10	0.2032	1.12	VQ				
3+15	0.2109	1.12	VQ				
3+20	0.2186	1.12	VQ				
3+25	0.2263	1.12	VQ				
3+30	0.2340	1.12	VQ				
3+35	0.2418	1.12	VQ				
3+40	0.2495	1.12	VQ				
3+45	0.2572	1.12	Q				
3+50	0.2652	1.17	Q				
3+55	0.2740	1.27	Q				
4+ 0	0.2830	1.31	Q				
4+ 5	0.2921	1.32	Q				
4+10	0.3013	1.33	Q				
4+15	0.3105	1.34	Q				
4+20	0.3204	1.44	Q				
4+25	0.3319	1.68	VQ				
4+30	0.3440	1.76	VQ				
4+35	0.3564	1.80	VQ				
4+40	0.3690	1.83	VQ				
4+45	0.3818	1.85	VQ				
4+50	0.3956	2.00	VQ				
4+55	0.4117	2.34	V Q				
5+ 0	0.4286	2.45	V Q				
5+ 5	0.4441	2.26	V Q				
5+10	0.4557	1.69	VQ				

5+15	0.4662	1.52	VQ				
5+20	0.4770	1.57	VQ				
5+25	0.4897	1.84	VQ				
5+30	0.5028	1.91	VQ				
5+35	0.5171	2.08	Q				
5+40	0.5338	2.42	VQ				
5+45	0.5513	2.54	VQ				
5+50	0.5692	2.61	VQ				
5+55	0.5875	2.65	VQ				
6+ 0	0.6059	2.68	VQ				
6+ 5	0.6254	2.83	VQ				
6+10	0.6473	3.17	V Q				
6+15	0.6699	3.28	V Q				
6+20	0.6929	3.34	V Q				
6+25	0.7162	3.38	V Q				
6+30	0.7397	3.41	V Q				
6+35	0.7642	3.56	V Q				
6+40	0.7910	3.90	V Q				
6+45	0.8187	4.01	V Q				
6+50	0.8467	4.07	V Q				
6+55	0.8749	4.10	V Q				
7+ 0	0.9034	4.13	V Q				
7+ 5	0.9320	4.15	V Q				
7+10	0.9607	4.17	V Q				
7+15	0.9895	4.18	V Q				
7+20	1.0193	4.33	V Q				
7+25	1.0514	4.66	V Q				
7+30	1.0842	4.77	V Q				
7+35	1.1184	4.96	V Q				
7+40	1.1550	5.32	V Q				
7+45	1.1925	5.44	V Q				
7+50	1.2313	5.64	V Q				
7+55	1.2727	6.01	V Q				
8+ 0	1.3149	6.13	V Q				
8+ 5	1.3594	6.47	V Q				
8+10	1.4087	7.15	V Q				
8+15	1.4595	7.38	V Q				
8+20	1.5111	7.49	V Q				
8+25	1.5631	7.56	V Q				
8+30	1.6155	7.60	V Q				
8+35	1.6689	7.76	V Q				
8+40	1.7248	8.11	V Q				
8+45	1.7814	8.22	V Q				
8+50	1.8393	8.41	V Q				
8+55	1.8997	8.77	V Q				
9+ 0	1.9610	8.89	V Q				
9+ 5	2.0245	9.23	V Q				
9+10	2.0928	9.91	V Q				
9+15	2.1626	10.14	V Q				
9+20	2.2341	10.38	V Q				
9+25	2.3082	10.77	V Q				
9+30	2.3834	10.91	V Q				
9+35	2.4600	11.12	V Q				
9+40	2.5392	11.49	V Q				
9+45	2.6192	11.62	V Q				
9+50	2.7006	11.82	V Q				
9+55	2.7845	12.18	V Q				
10+ 0	2.8692	12.31	V Q				
10+ 5	2.9480	11.43	V Q				
10+10	3.0116	9.24	VQ				

10+15	3.0706	8.57		Q			
10+20	3.1275	8.27		QV			
10+25	3.1834	8.11		Q V			
10+30	3.2385	8.01		Q V			
10+35	3.2979	8.62		QV			
10+40	3.3679	10.17		Q			
10+45	3.4415	10.68		VQ			
10+50	3.5166	10.91		VQ			
10+55	3.5927	11.05		VQ			
11+ 0	3.6694	11.14		Q			
11+ 5	3.7456	11.06		Q			
11+10	3.8200	10.80		Q			
11+15	3.8937	10.71		QV			
11+20	3.9672	10.67		QV			
11+25	4.0406	10.65		QV			
11+30	4.1139	10.65		Q V			
11+35	4.1854	10.38		Q V			
11+40	4.2525	9.74		Q V			
11+45	4.3182	9.55		Q V			
11+50	4.3843	9.60		Q V			
11+55	4.4524	9.88		Q V			
12+ 0	4.5210	9.96		Q V			
12+ 5	4.5963	10.93		Q V			
12+10	4.6871	13.19		QV			
12+15	4.7829	13.91		Q			
12+20	4.8819	14.38		Q			
12+25	4.9845	14.90		Q			
12+30	5.0886	15.12		VQ			
12+35	5.1954	15.51		Q			
12+40	5.3073	16.24		VQ			
12+45	5.4207	16.47		Q			
12+50	5.5358	16.71		VQ			
12+55	5.6535	17.10		Q			
13+ 0	5.7722	17.24		Q			
13+ 5	5.8961	17.98		VQ			
13+10	6.0313	19.63		V Q			
13+15	6.1701	20.15		V Q			
13+20	6.3106	20.40		V Q			
13+25	6.4520	20.54		V Q			
13+30	6.5941	20.63		V Q			
13+35	6.7265	19.21		QV			
13+40	6.8349	15.74		Q			
13+45	6.9358	14.66		Q			
13+50	7.0334	14.17		Q			
13+55	7.1291	13.90		Q			
14+ 0	7.2236	13.73		Q			
14+ 5	7.3212	14.16		Q			
14+10	7.4270	15.36		Q			
14+15	7.5356	15.77		Q			
14+20	7.6446	15.82		Q			
14+25	7.7521	15.61		Q			
14+30	7.8594	15.59		Q			
14+35	7.9668	15.59		Q			
14+40	8.0742	15.60		Q			
14+45	8.1816	15.60		Q			
14+50	8.2881	15.46		Q			
14+55	8.3924	15.14		Q			
15+ 0	8.4960	15.05		Q			
15+ 5	8.5985	14.88		Q			
15+10	8.6986	14.54		Q			

15+15	8.7980	14.43						V	
15+20	8.8961	14.25						V	
15+25	8.9918	13.90						V	
15+30	9.0868	13.79						V	
15+35	9.1778	13.21						V	
15+40	9.2598	11.90						V	
15+45	9.3390	11.50						V	
15+50	9.4169	11.31						V	
15+55	9.4941	11.21						V	
16+ 0	9.5709	11.15						V	
16+ 5	9.6337	9.11						V	
16+10	9.6631	4.28						V	
16+15	9.6824	2.80						V	
16+20	9.6970	2.13						V	
16+25	9.7091	1.75						V	
16+30	9.7196	1.52						V	
16+35	9.7282	1.26						V	
16+40	9.7341	0.85						V	
16+45	9.7393	0.76						V	
16+50	9.7443	0.72						V	
16+55	9.7492	0.70						V	
17+ 0	9.7539	0.69						V	
17+ 5	9.7604	0.94						V	
17+10	9.7712	1.56						V	
17+15	9.7833	1.76						V	
17+20	9.7961	1.86						V	
17+25	9.8093	1.91						V	
17+30	9.8227	1.95						V	
17+35	9.8363	1.98						V	
17+40	9.8501	2.00						V	
17+45	9.8639	2.01						V	
17+50	9.8768	1.88						V	
17+55	9.8876	1.56						V	
18+ 0	9.8977	1.47						V	
18+ 5	9.9076	1.43						V	
18+10	9.9173	1.41						V	
18+15	9.9270	1.40						V	
18+20	9.9366	1.40						V	
18+25	9.9462	1.40						V	
18+30	9.9559	1.40						V	
18+35	9.9647	1.27						V	
18+40	9.9713	0.96						V	
18+45	9.9773	0.87						V	
18+50	9.9825	0.76						V	
18+55	9.9865	0.58						V	
19+ 0	9.9901	0.52						V	
19+ 5	9.9939	0.56						V	
19+10	9.9987	0.70						V	
19+15	10.0039	0.75						V	
19+20	10.0102	0.91						V	
19+25	10.0187	1.24						V	
19+30	10.0281	1.36						V	
19+35	10.0369	1.28						V	
19+40	10.0437	0.99						V	
19+45	10.0500	0.92						V	
19+50	10.0556	0.81						V	
19+55	10.0597	0.60						V	
20+ 0	10.0634	0.53						V	
20+ 5	10.0673	0.57						V	
20+10	10.0725	0.75						V	

20+15	10.0780	0.81	Q				V
20+20	10.0838	0.83	Q				V
20+25	10.0896	0.85	Q				V
20+30	10.0956	0.86	Q				V
20+35	10.1016	0.87	Q				V
20+40	10.1077	0.88	Q				V
20+45	10.1138	0.89	Q				V
20+50	10.1193	0.80	Q				V
20+55	10.1233	0.58	Q				V
21+ 0	10.1269	0.52	Q				V
21+ 5	10.1309	0.58	Q				V
21+10	10.1363	0.79	Q				V
21+15	10.1422	0.85	Q				V
21+20	10.1476	0.79	Q				V
21+25	10.1515	0.57	Q				V
21+30	10.1551	0.51	Q				V
21+35	10.1591	0.58	Q				V
21+40	10.1646	0.81	Q				V
21+45	10.1707	0.87	Q				V
21+50	10.1762	0.80	Q				V
21+55	10.1802	0.58	Q				V
22+ 0	10.1837	0.51	Q				V
22+ 5	10.1878	0.59	Q				V
22+10	10.1934	0.83	Q				V
22+15	10.1996	0.89	Q				V
22+20	10.2052	0.82	Q				V
22+25	10.2092	0.58	Q				V
22+30	10.2128	0.52	Q				V
22+35	10.2161	0.49	Q				V
22+40	10.2194	0.47	Q				V
22+45	10.2226	0.46	Q				V
22+50	10.2257	0.45	Q				V
22+55	10.2288	0.45	Q				V
23+ 0	10.2319	0.45	Q				V
23+ 5	10.2350	0.45	Q				V
23+10	10.2380	0.45	Q				V
23+15	10.2411	0.45	Q				V
23+20	10.2442	0.45	Q				V
23+25	10.2473	0.45	Q				V
23+30	10.2504	0.45	Q				V
23+35	10.2535	0.45	Q				V
23+40	10.2565	0.45	Q				V
23+45	10.2596	0.45	Q				V
23+50	10.2627	0.45	Q				V
23+55	10.2658	0.45	Q				V
24+ 0	10.2689	0.45	Q				V
24+ 5	10.2713	0.36	Q				V
24+10	10.2723	0.14	Q				V
24+15	10.2728	0.07	Q				V
24+20	10.2731	0.04	Q				V
24+25	10.2732	0.02	Q				V
24+30	10.2733	0.01	Q				V
24+35	10.2733	0.01	Q				V

**PRELIMINARY DRAINAGE ANALYSIS
OLD 215 INDUSTRIAL BUILDING (PEN21-0325 / LST22-0007)
CITY OF MORENO VALLEY, CA**

APPENDIX E.3

NORMAL DEPTH CALCULATIONS FOR STORM DRAIN

Worksheet for Area B1

Project Description

Friction Method	Manning Formula
Solve For	Discharge

Input Data

Roughness Coefficient	0.013	
Channel Slope	0.02000	ft/ft
Normal Depth	1.90	ft
Diameter	2.00	ft

Results

Discharge	34.37	ft ³ /s
Flow Area	3.08	ft ²
Wetted Perimeter	5.38	ft
Hydraulic Radius	0.57	ft
Top Width	0.87	ft
Critical Depth	1.91	ft
Percent Full	95.0	%
Critical Slope	0.02008	ft/ft
Velocity	11.15	ft/s
Velocity Head	1.93	ft
Specific Energy	3.83	ft
Froude Number	1.05	
Maximum Discharge	34.41	ft ³ /s
Discharge Full	31.99	ft ³ /s
Slope Full	0.02309	ft/ft
Flow Type	SuperCritical	

GVF Input Data

Downstream Depth	0.00	ft
Length	0.00	ft
Number Of Steps	0	

GVF Output Data

Upstream Depth	0.00	ft
Profile Description		
Profile Headloss	0.00	ft
Average End Depth Over Rise	0.00	%
Normal Depth Over Rise	95.00	%
Downstream Velocity	Infinity	ft/s

Worksheet for Area B1

GVF Output Data

Upstream Velocity	Infinity	ft/s
Normal Depth	1.90	ft
Critical Depth	1.91	ft
Channel Slope	0.02000	ft/ft
Critical Slope	0.02008	ft/ft

Worksheet for Area B2

Project Description

Friction Method	Manning Formula
Solve For	Discharge

Input Data

Roughness Coefficient	0.013	
Channel Slope	0.01000	ft/ft
Normal Depth	1.90	ft
Diameter	2.00	ft

Results

Discharge	24.31	ft ³ /s
Flow Area	3.08	ft ²
Wetted Perimeter	5.38	ft
Hydraulic Radius	0.57	ft
Top Width	0.87	ft
Critical Depth	1.74	ft
Percent Full	95.0	%
Critical Slope	0.01050	ft/ft
Velocity	7.88	ft/s
Velocity Head	0.97	ft
Specific Energy	2.87	ft
Froude Number	0.74	
Maximum Discharge	24.33	ft ³ /s
Discharge Full	22.62	ft ³ /s
Slope Full	0.01155	ft/ft
Flow Type	SubCritical	

GVF Input Data

Downstream Depth	0.00	ft
Length	0.00	ft
Number Of Steps	0	

GVF Output Data

Upstream Depth	0.00	ft
Profile Description		
Profile Headloss	0.00	ft
Average End Depth Over Rise	0.00	%
Normal Depth Over Rise	95.00	%
Downstream Velocity	Infinity	ft/s

Worksheet for Area B2

GVF Output Data

Upstream Velocity	Infinity	ft/s
Normal Depth	1.90	ft
Critical Depth	1.74	ft
Channel Slope	0.01000	ft/ft
Critical Slope	0.01050	ft/ft

**PRELIMINARY DRAINAGE ANALYSIS
OLD 215 INDUSTRIAL BUILDING (PEN21-0325 / LST22-0007)
CITY OF MORENO VALLEY, CA**

APPENDIX F

REFERENCES

Hydrologic Soil Group—Western Riverside Area, California



Soil Map may not be valid at this scale.

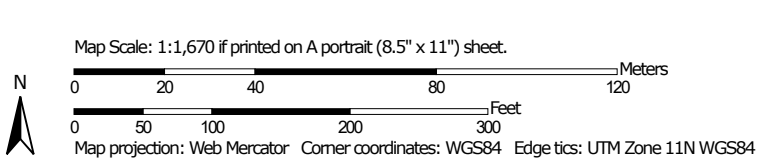

MAP LEGEND

Area of Interest (AOI)









 Area of Interest (AOI)

Soils

Soil Rating Polygons





 A
 A/D
 B
 B/D
 C
 C/D
 D
 Not rated or not available

Soil Rating Lines

 A
 A/D
 B
 B/D
 C
 C/D
 D
 Not rated or not available

Soil Rating Points





 A
 A/D
 B
 B/D

 C
 C/D
 D
 Not rated or not available

Water Features

 Streams and Canals

Transportation

 Rails
 Interstate Highways
 US Routes
 Major Roads
 Local Roads

Background

 Aerial Photography

MAP INFORMATION

The soil surveys that comprise your AOI were mapped at 1:15,800.

Warning: Soil Map may not be valid at this scale.

Enlargement of maps beyond the scale of mapping can cause misunderstanding of the detail of mapping and accuracy of soil line placement. The maps do not show the small areas of contrasting soils that could have been shown at a more detailed scale.

Please rely on the bar scale on each map sheet for map measurements.

Source of Map: Natural Resources Conservation Service
 Web Soil Survey URL:
 Coordinate System: Web Mercator (EPSG:3857)

Maps from the Web Soil Survey are based on the Web Mercator projection, which preserves direction and shape but distorts distance and area. A projection that preserves area, such as the Albers equal-area conic projection, should be used if more accurate calculations of distance or area are required.

This product is generated from the USDA-NRCS certified data as of the version date(s) listed below.

Soil Survey Area: Western Riverside Area, California
 Survey Area Data: Version 13, May 27, 2020

Soil map units are labeled (as space allows) for map scales 1:50,000 or larger.

Date(s) aerial images were photographed: May 25, 2019—Jun 25, 2019

The orthophoto or other base map on which the soil lines were compiled and digitized probably differs from the background imagery displayed on these maps. As a result, some minor shifting of map unit boundaries may be evident.

Hydrologic Soil Group

Map unit symbol	Map unit name	Rating	Acres in AOI	Percent of AOI
MmB	Monserate sandy loam, 0 to 5 percent slopes	C	6.0	81.9%
MmC2	Monserate sandy loam, 5 to 8 percent slopes, eroded	C	1.3	18.1%
Totals for Area of Interest			7.3	100.0%

Description

Hydrologic soil groups are based on estimates of runoff potential. Soils are assigned to one of four groups according to the rate of water infiltration when the soils are not protected by vegetation, are thoroughly wet, and receive precipitation from long-duration storms.

The soils in the United States are assigned to four groups (A, B, C, and D) and three dual classes (A/D, B/D, and C/D). The groups are defined as follows:

Group A. Soils having a high infiltration rate (low runoff potential) when thoroughly wet. These consist mainly of deep, well drained to excessively drained sands or gravelly sands. These soils have a high rate of water transmission.

Group B. Soils having a moderate infiltration rate when thoroughly wet. These consist chiefly of moderately deep or deep, moderately well drained or well drained soils that have moderately fine texture to moderately coarse texture. These soils have a moderate rate of water transmission.

Group C. Soils having a slow infiltration rate when thoroughly wet. These consist chiefly of soils having a layer that impedes the downward movement of water or soils of moderately fine texture or fine texture. These soils have a slow rate of water transmission.

Group D. Soils having a very slow infiltration rate (high runoff potential) when thoroughly wet. These consist chiefly of clays that have a high shrink-swell potential, soils that have a high water table, soils that have a claypan or clay layer at or near the surface, and soils that are shallow over nearly impervious material. These soils have a very slow rate of water transmission.

If a soil is assigned to a dual hydrologic group (A/D, B/D, or C/D), the first letter is for drained areas and the second is for undrained areas. Only the soils that in their natural condition are in group D are assigned to dual classes.

Rating Options

Aggregation Method: Dominant Condition

Component Percent Cutoff: None Specified

Tie-break Rule: Higher



NOAA Atlas 14, Volume 6, Version 2
Location name: Moreno Valley, California, USA*
Latitude: 33.9227°, Longitude: -117.2843°
Elevation: 1533.56 ft**



* source: ESRI Maps
 ** source: USGS

POINT PRECIPITATION FREQUENCY ESTIMATES

Sanja Perica, Sarah Dietz, Sarah Heim, Lillian Hiner, Kazungu Maitaria, Deborah Martin, Sandra Pavlovic, Ishani Roy, Carl Tryppaluk, Dale Unruh, Fenglin Yan, Michael Yekta, Tan Zhao, Geoffrey Bonnin, Daniel Brewer, Li-Chuan Chen, Tye Parzybok, John Yarchoan

NOAA, National Weather Service, Silver Spring, Maryland

[PF_tabular](#) | [PF_graphical](#) | [Maps_&_aerials](#)

PF tabular

PDS-based point precipitation frequency estimates with 90% confidence intervals (in inches)¹										
Duration	Average recurrence interval (years)									
	1	2	5	10	25	50	100	200	500	1000
5-min	0.090 (0.075-0.108)	0.118 (0.099-0.143)	0.157 (0.131-0.191)	0.190 (0.156-0.232)	0.235 (0.187-0.299)	0.272 (0.212-0.353)	0.310 (0.236-0.413)	0.351 (0.259-0.481)	0.409 (0.289-0.585)	0.456 (0.311-0.675)
10-min	0.128 (0.107-0.155)	0.169 (0.141-0.205)	0.225 (0.187-0.273)	0.272 (0.224-0.333)	0.337 (0.269-0.428)	0.390 (0.304-0.506)	0.445 (0.338-0.592)	0.504 (0.371-0.690)	0.586 (0.414-0.838)	0.653 (0.445-0.968)
15-min	0.155 (0.130-0.188)	0.205 (0.171-0.248)	0.272 (0.226-0.331)	0.329 (0.271-0.403)	0.408 (0.325-0.518)	0.472 (0.367-0.611)	0.538 (0.409-0.716)	0.609 (0.449-0.834)	0.709 (0.501-1.01)	0.790 (0.538-1.17)
30-min	0.238 (0.199-0.288)	0.314 (0.262-0.381)	0.417 (0.347-0.507)	0.504 (0.416-0.618)	0.626 (0.498-0.794)	0.723 (0.564-0.938)	0.826 (0.627-1.10)	0.934 (0.689-1.28)	1.09 (0.768-1.56)	1.21 (0.826-1.80)
60-min	0.341 (0.285-0.413)	0.450 (0.375-0.545)	0.597 (0.497-0.726)	0.721 (0.595-0.884)	0.896 (0.713-1.14)	1.03 (0.807-1.34)	1.18 (0.897-1.57)	1.34 (0.986-1.83)	1.56 (1.10-2.23)	1.74 (1.18-2.57)
2-hr	0.494 (0.413-0.598)	0.639 (0.532-0.774)	0.831 (0.691-1.01)	0.990 (0.816-1.21)	1.21 (0.963-1.54)	1.38 (1.08-1.79)	1.56 (1.18-2.07)	1.75 (1.29-2.39)	2.00 (1.41-2.86)	2.20 (1.50-3.27)
3-hr	0.603 (0.503-0.730)	0.774 (0.645-0.938)	1.00 (0.832-1.22)	1.19 (0.978-1.45)	1.44 (1.15-1.83)	1.64 (1.28-2.13)	1.84 (1.40-2.45)	2.06 (1.52-2.81)	2.34 (1.66-3.35)	2.57 (1.75-3.81)
6-hr	0.830 (0.693-1.00)	1.06 (0.885-1.29)	1.37 (1.14-1.66)	1.61 (1.33-1.98)	1.95 (1.55-2.48)	2.21 (1.72-2.87)	2.48 (1.88-3.29)	2.75 (2.03-3.77)	3.12 (2.20-4.46)	3.41 (2.32-5.05)
12-hr	1.08 (0.901-1.31)	1.39 (1.16-1.69)	1.80 (1.50-2.19)	2.14 (1.76-2.62)	2.59 (2.06-3.29)	2.94 (2.29-3.81)	3.29 (2.50-4.38)	3.65 (2.69-5.00)	4.14 (2.93-5.93)	4.52 (3.08-6.71)
24-hr	1.41 (1.25-1.63)	1.85 (1.64-2.14)	2.43 (2.14-2.81)	2.90 (2.53-3.38)	3.53 (2.99-4.26)	4.02 (3.34-4.95)	4.52 (3.66-5.70)	5.03 (3.97-6.52)	5.73 (4.34-7.72)	6.27 (4.59-8.74)
2-day	1.69 (1.49-1.95)	2.25 (1.99-2.60)	2.99 (2.64-3.46)	3.59 (3.14-4.19)	4.42 (3.74-5.32)	5.05 (4.19-6.22)	5.70 (4.62-7.18)	6.37 (5.02-8.24)	7.28 (5.51-9.81)	7.99 (5.85-11.1)
3-day	1.81 (1.60-2.08)	2.44 (2.16-2.82)	3.28 (2.89-3.79)	3.96 (3.46-4.62)	4.90 (4.15-5.90)	5.62 (4.66-6.92)	6.36 (5.16-8.02)	7.13 (5.62-9.23)	8.18 (6.19-11.0)	8.99 (6.58-12.5)
4-day	1.95 (1.73-2.25)	2.66 (2.35-3.07)	3.60 (3.17-4.17)	4.37 (3.82-5.10)	5.43 (4.59-6.54)	6.25 (5.18-7.68)	7.09 (5.74-8.92)	7.96 (6.27-10.3)	9.15 (6.93-12.3)	10.1 (7.38-14.1)
7-day	2.21 (1.96-2.55)	3.06 (2.70-3.53)	4.18 (3.69-4.85)	5.12 (4.47-5.97)	6.40 (5.42-7.71)	7.40 (6.14-9.10)	8.42 (6.82-10.6)	9.49 (7.48-12.3)	11.0 (8.30-14.8)	12.1 (8.87-16.9)
10-day	2.36 (2.09-2.72)	3.29 (2.91-3.80)	4.54 (4.00-5.26)	5.58 (4.88-6.51)	7.01 (5.93-8.44)	8.13 (6.74-9.99)	9.28 (7.52-11.7)	10.5 (8.26-13.6)	12.1 (9.19-16.4)	13.5 (9.85-18.8)
20-day	2.81 (2.49-3.24)	3.97 (3.51-4.59)	5.54 (4.89-6.42)	6.86 (6.00-8.00)	8.70 (7.36-10.5)	10.2 (8.42-12.5)	11.7 (9.45-14.7)	13.3 (10.5-17.2)	15.5 (11.7-20.9)	17.2 (12.6-24.0)
30-day	3.33 (2.95-3.84)	4.70 (4.15-5.42)	6.56 (5.79-7.60)	8.14 (7.12-9.49)	10.4 (8.77-12.5)	12.1 (10.1-14.9)	14.0 (11.3-17.6)	16.0 (12.6-20.7)	18.7 (14.2-25.2)	20.9 (15.3-29.2)
45-day	3.95 (3.50-4.56)	5.53 (4.88-6.38)	7.69 (6.78-8.90)	9.53 (8.34-11.1)	12.2 (10.3-14.7)	14.3 (11.8-17.6)	16.5 (13.4-20.8)	18.9 (14.9-24.5)	22.3 (16.8-30.0)	25.0 (18.3-34.8)
60-day	4.60 (4.07-5.30)	6.34 (5.60-7.32)	8.76 (7.72-10.1)	10.8 (9.47-12.6)	13.8 (11.7-16.6)	16.2 (13.4-19.9)	18.8 (15.2-23.6)	21.5 (17.0-27.8)	25.4 (19.2-34.2)	28.6 (20.9-39.8)

¹ Precipitation frequency (PF) estimates in this table are based on frequency analysis of partial duration series (PDS). Numbers in parenthesis are PF estimates at lower and upper bounds of the 90% confidence interval. The probability that precipitation frequency estimates (for a given duration and average recurrence interval) will be greater than the upper bound (or less than the lower bound) is 5%. Estimates at upper bounds are not checked against probable maximum precipitation (PMP) estimates and may be higher than currently valid PMP values. Please refer to NOAA Atlas 14 document for more information.

[Back to Top](#)

PF graphical

PDS-based depth-duration-frequency (DDF) curves

Latitude: 33.9227°, Longitude: -117.2843°

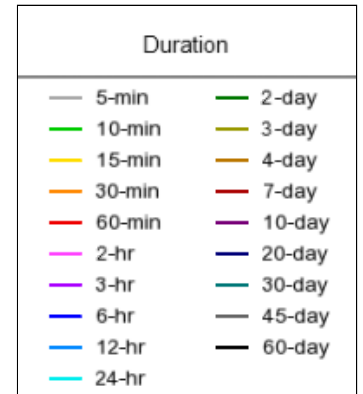
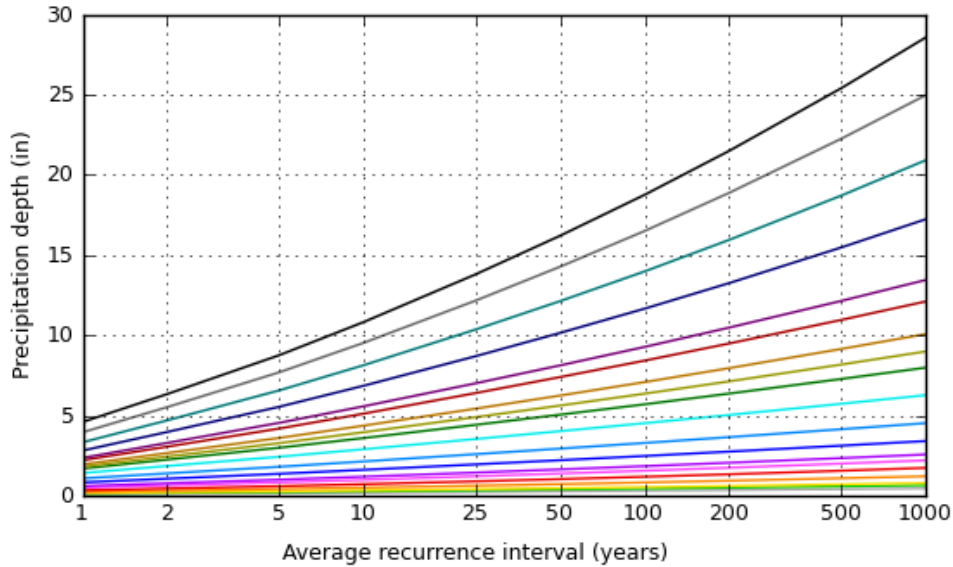
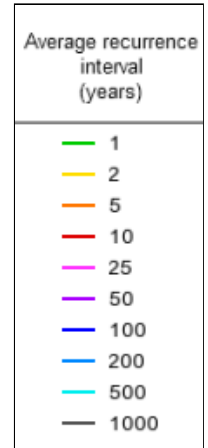
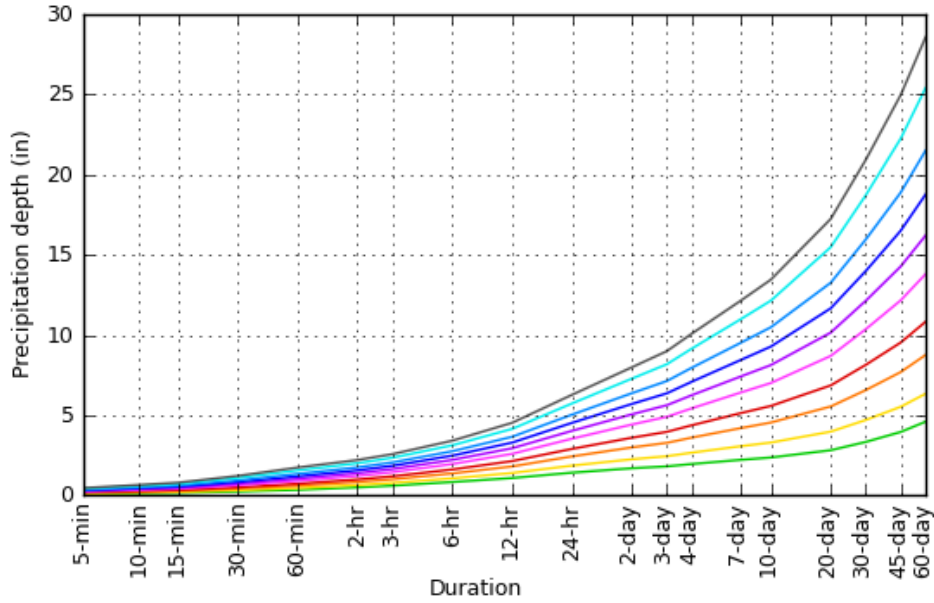

[Back to Top](#)

Maps & aerials

Small scale terrain

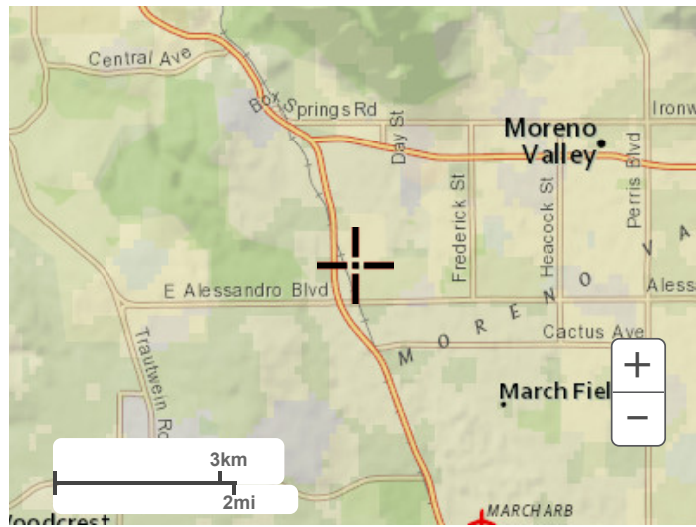

Large scale terrain



Large scale map



Large scale aerial

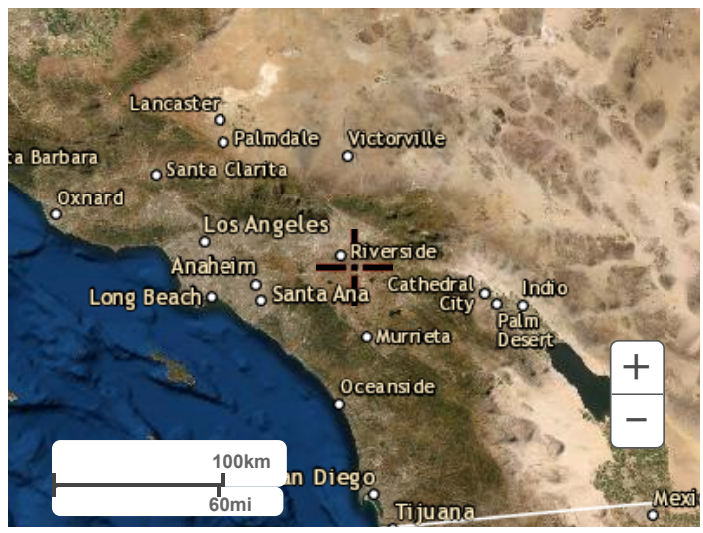

[Back to Top](#)

[US Department of Commerce](#)
[National Oceanic and Atmospheric Administration](#)
[National Weather Service](#)
[National Water Center](#)
1325 East West Highway
Silver Spring, MD 20910
Questions?: HDSC.Questions@noaa.gov

[Disclaimer](#)

RUNOFF INDEX NUMBERS OF HYDROLOGIC SOIL-COVER COMPLEXES FOR PERVIOUS AREAS-AMC II

Cover Type (3)	Quality of Cover (2)	Soil Group			
		A	B	C	D
<u>NATURAL COVERS -</u>					
Barren (Rockland, eroded and graded land)		78	86	91	93
Chaparrel, Broadleaf (Manzonita, ceanothus and scrub oak)	Poor	53	70	80	85
	Fair	40	63	75	81
	Good	31	57	71	78
Chaparrel, Narrowleaf (Chamise and redshank)	Poor	71	82	88	91
	Fair	55	72	81	86
Grass, Annual or Perennial	Poor	67	78	86	89
	Fair	50	69	79	84
	Good	38	61	74	80
Meadows or Cienegas (Areas with seasonally high water table, principal vegetation is sod forming grass)	Poor	63	77	85	88
	Fair	51	70	80	84
	Good	30	58	72	78
Open Brush (Soft wood shrubs - buckwheat, sage, etc.)	Poor	62	76	84	88
	Fair	46	66	77	83
	Good	41	63	75	81
Woodland (Coniferous or broadleaf trees predominate. Canopy density is at least 50 percent)	Poor	45	66	77	83
	Fair	36	60	73	79
	Good	28	55	70	77
Woodland, Grass (Coniferous or broadleaf trees with canopy density from 20 to 50 percent)	Poor	57	73	82	86
	Fair	44	65	77	82
	Good	33	58	72	79
<u>URBAN COVERS -</u>					
Residential or Commercial Landscaping (Lawn, shrubs, etc.)	Good	32	56	69	75
Turf (Irrigated and mowed grass)	Poor	58	74	83	87
	Fair	44	65	77	82
	Good	33	58	72	79
<u>AGRICULTURAL COVERS -</u>					
Fallow (Land plowed but not tilled or seeded)		76	85	90	92

RCFC & WCD
HYDROLOGY MANUAL

RUNOFF INDEX NUMBERS
FOR
PERVIOUS AREA

RUNOFF INDEX NUMBERS OF HYDROLOGIC SOIL-COVER COMPLEXES FOR PERVIOUS AREAS-AMC II

Cover Type (3)	Quality of Cover (2)	Soil Group			
		A	B	C	D
<u>AGRICULTURAL COVERS</u> (cont.) -					
Legumes, Close Seeded (Alfalfa, sweetclover, timothy, etc.)	Poor	66	77	85	89
	Good	58	72	81	85
Orchards, Deciduous (Apples, apricots, pears, walnuts, etc.)	See Note 4				
Orchards, Evergreen (Citrus, avocados, etc.)	Poor	57	73	82	86
	Fair	44	65	77	82
	Good	33	58	72	79
Pasture, Dryland (Annual grasses)	Poor	67	78	86	89
	Fair	50	69	79	84
	Good	38	61	74	80
Pasture, Irrigated (Legumes and perennial grass)	Poor	58	74	83	87
	Fair	44	65	77	82
	Good	33	58	72	79
Row Crops (Field crops - tomatoes, sugar beets, etc.)	Poor	72	81	88	91
	Good	67	78	85	89
Small Grain (Wheat, oats, barley, etc.)	Poor	65	76	84	88
	Good	63	75	83	87
Vineyard	See Note 4				

Notes:

1. All runoff index (RI) numbers are for Antecedent Moisture Condition (AMC) II.
2. Quality of cover definitions:
 Poor-Heavily grazed or regularly burned areas. Less than 50 percent of the ground surface is protected by plant cover or brush and tree canopy.
 Fair-Moderate cover with 50 percent to 75 percent of the ground surface protected.
 Good-Heavy or dense cover with more than 75 percent of the ground surface protected.
3. See Plate C-2 for a detailed description of cover types.
4. Use runoff index numbers based on ground cover type. See discussion under "Cover Type Descriptions" on Plate C-2.
5. Reference Bibliography item 17.

RCFC & WCD
HYDROLOGY MANUAL

**RUNOFF INDEX NUMBERS
FOR
PERVIOUS AREA**

**PRELIMINARY DRAINAGE ANALYSIS
OLD 215 INDUSTRIAL BUILDING (PEN21-0325 / LST22-0007)
CITY OF MORENO VALLEY, CA**

EXHIBIT A

HYDROLOGY MAP (EXISTING CONDITION; RATIONAL METHOD)

Drawing Name: C:\Users\jg0096\OneDrive\Documents\Hydrology Maps\1494-0006 HYDROLOGY MAP.dwg
 Last Updated: Mar 17, 2022 8:35am by jg0096

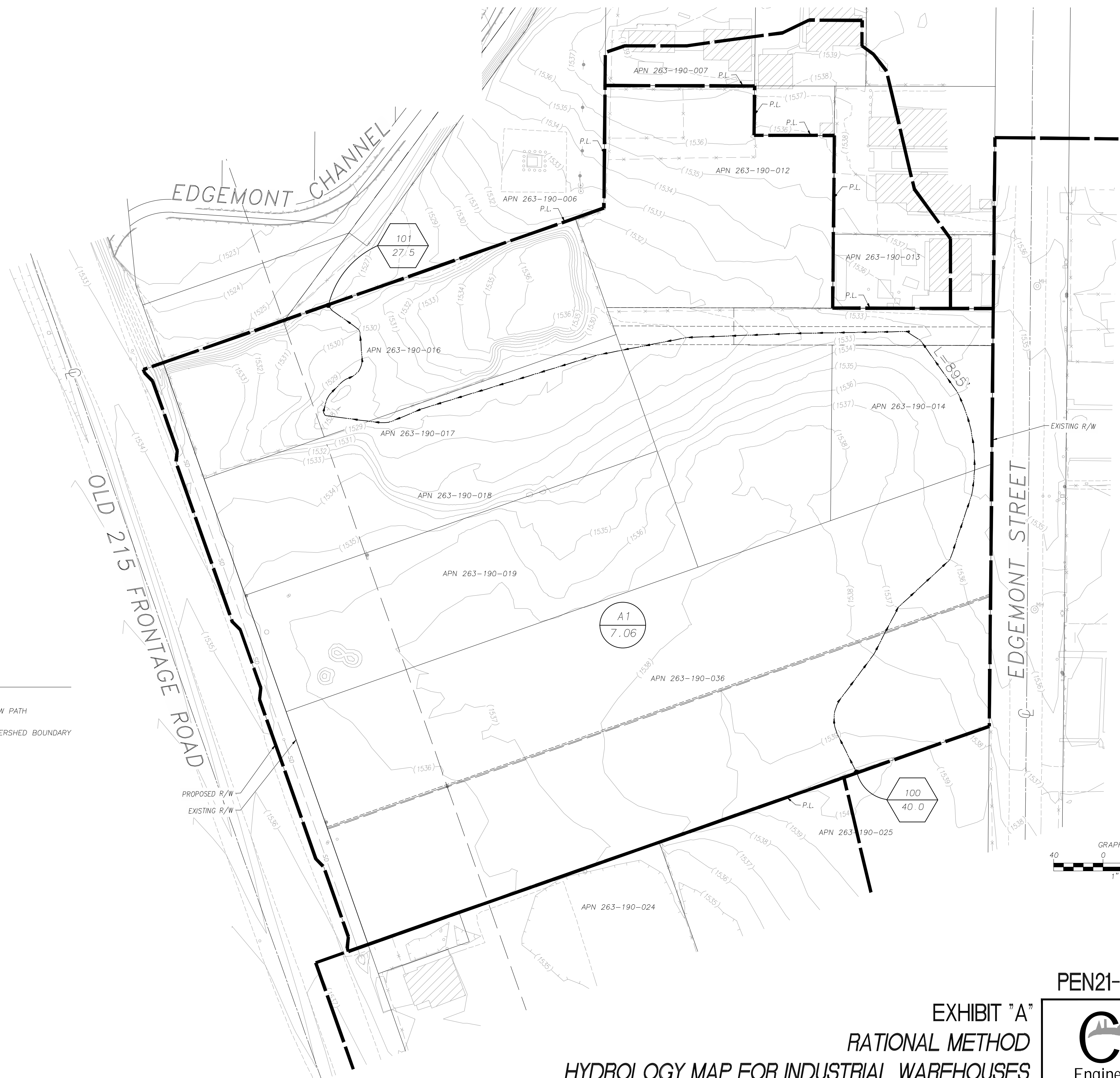

LEGEND

- NODE/CONCENTRATION POINT

 ELEVATION
- FLOW PATH
- WATERSHED BOUNDARY
- SUBAREA

 ACRES
- MAIN FLOW PATH

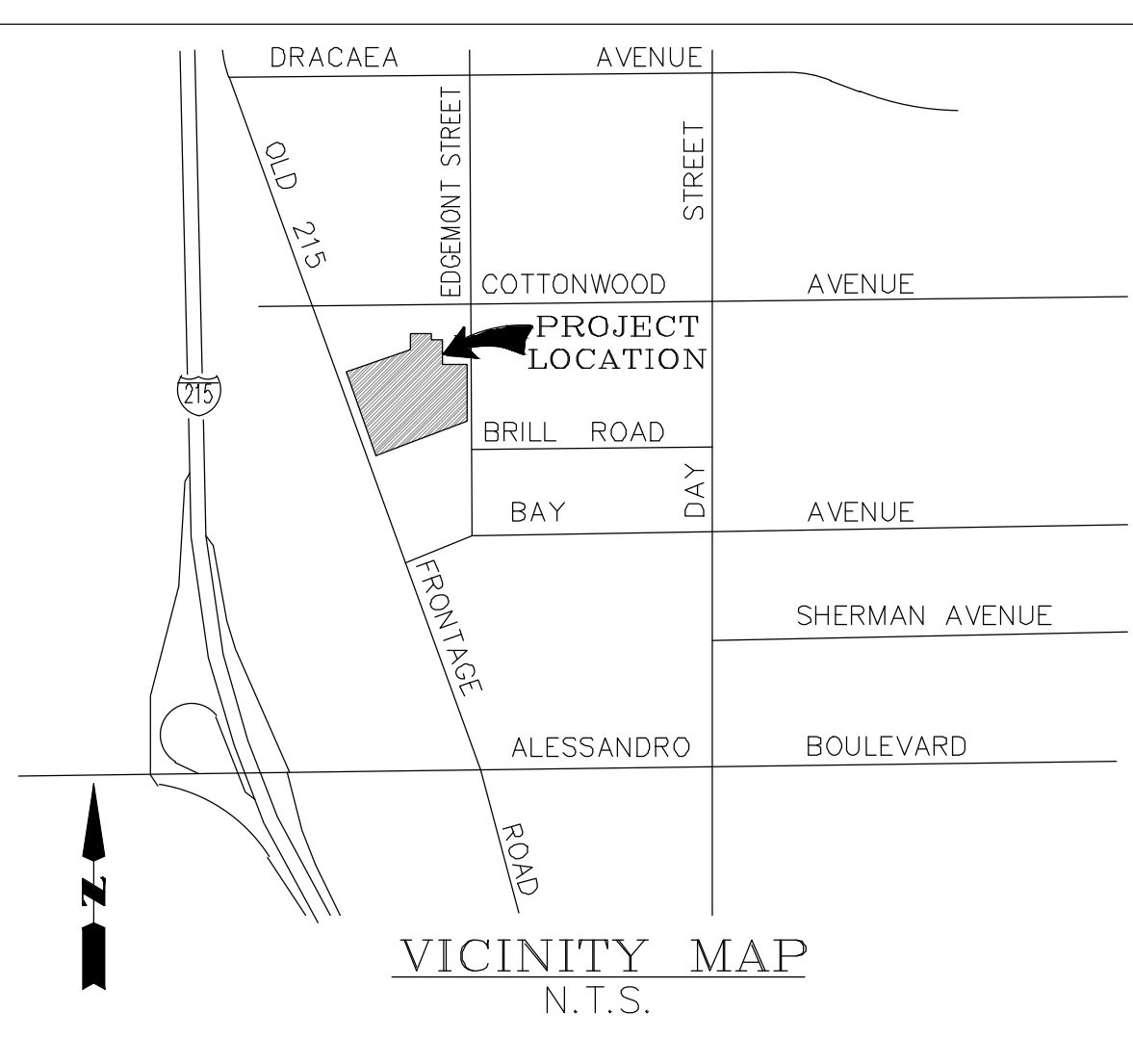
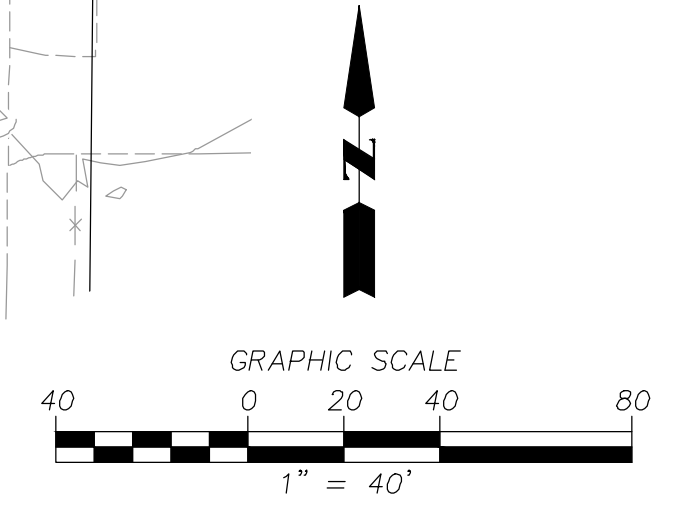

EXHIBIT "A"
RATIONAL METHOD
HYDROLOGY MAP FOR INDUSTRIAL WAREHOUSES
EXISTING CONDITION

PEN21-0325/LST22-0007

CASC

Engineering and Consulting

1475 E. 145th St., Hayward, CA 94541
 P.O. Box 999, Hayward, CA 94541
 Tel: (925) 783-0100 Fax: (925) 783-0135
 www.casc-engineering.com

**PRELIMINARY DRAINAGE ANALYSIS
OLD 215 INDUSTRIAL BUILDING (PEN21-0325 / LST22-0007)
CITY OF MORENO VALLEY, CA**

EXHIBIT B

HYDROLOGY MAP (PROPOSED CONDITION; RATIONAL METHOD)

Drawing Name: C:\Users\jg098\OneDrive\Documents\Hydrology Maps\1494-0006-HYDROLOGY MAP.dwg
 Last Updated: Mar 17, 2022 11:38am by jg098

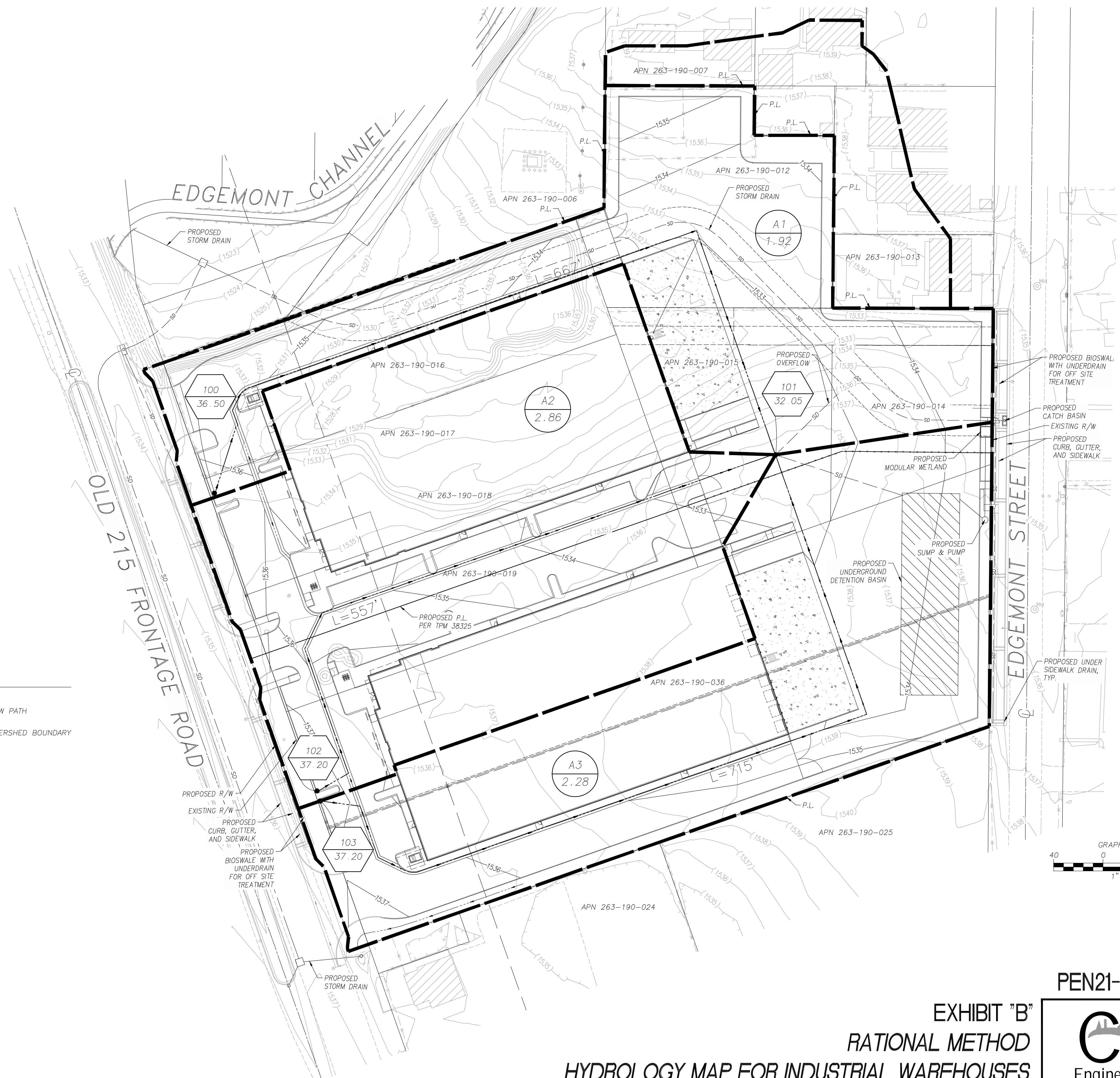

LEGEND

- NODE/CONCENTRATION POINT
ELEVATION
- FLOW PATH
- WATERSHED BOUNDARY
- SUBAREA
ACRES
- MAIN FLOW PATH

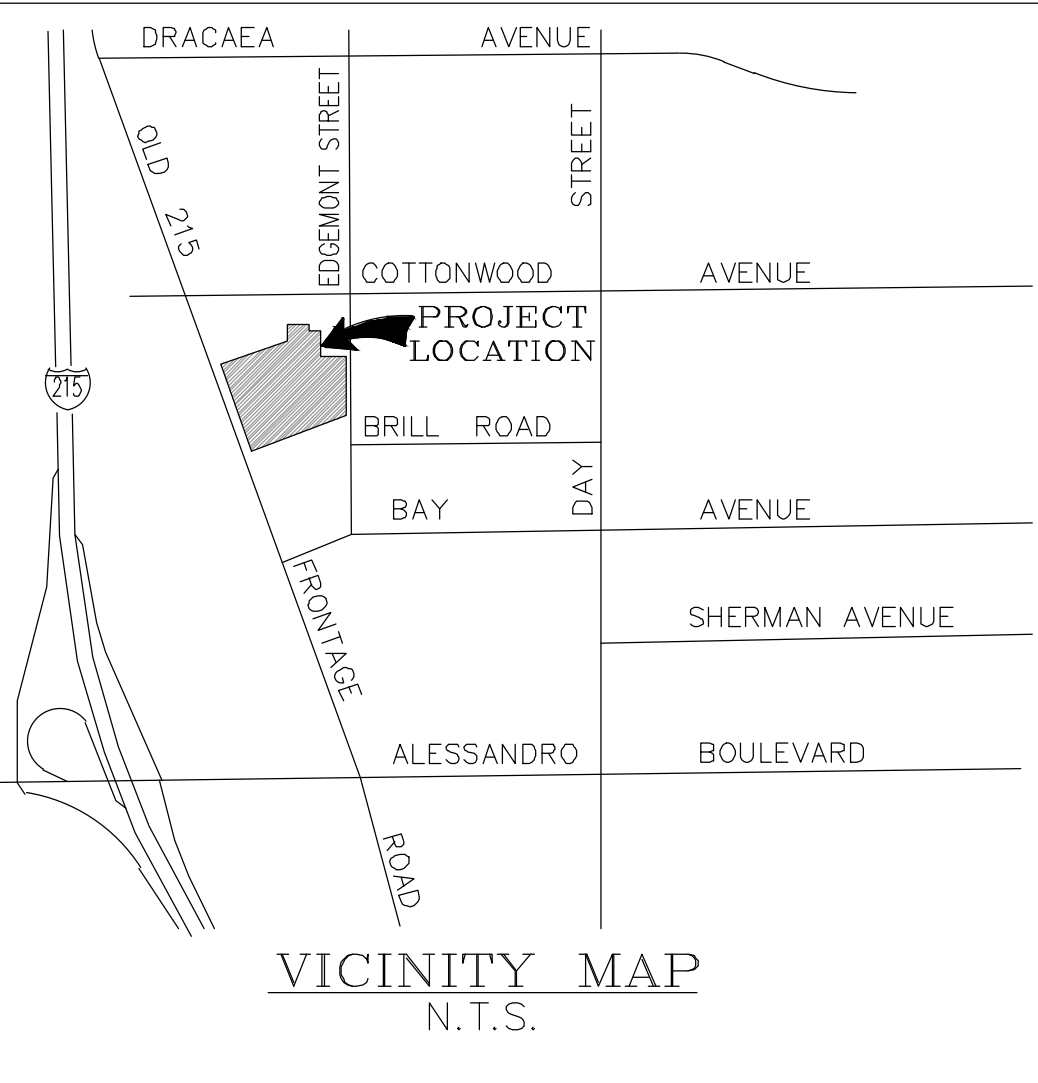
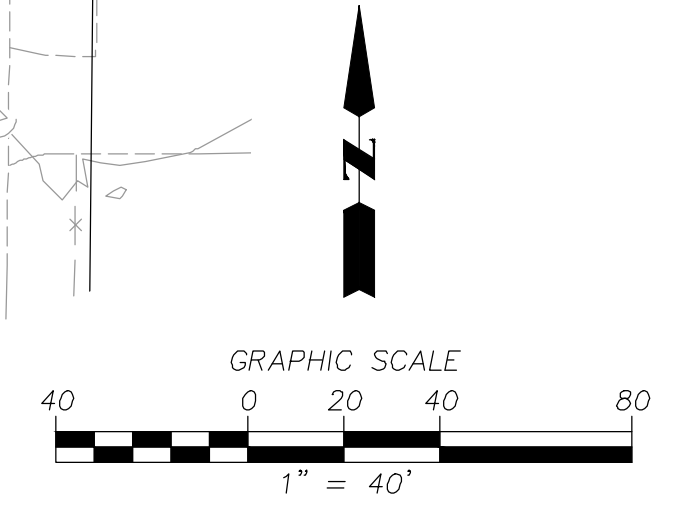

EXHIBIT "B"
RATIONAL METHOD
HYDROLOGY MAP FOR INDUSTRIAL WAREHOUSES
PROPOSED CONDITION

PEN21-0325/LST22-0007

CASC
 Engineering and Consulting
 1770 17th St. #100, San Diego, CA 92161
 P: (619) 783-0101 F: (619) 783-0135
 www.casc-engineering.com

**PRELIMINARY DRAINAGE ANALYSIS
OLD 215 INDUSTRIAL BUILDING (PEN21-0325 / LST22-0007)
CITY OF MORENO VALLEY, CA**

EXHIBIT C

HYDROLOGY MAP (OFF SITE; UNIT HYDROGRAPH METHOD)

Project Name: C:\Users\jg098\OneDrive\Hydrology\Map\1494-0006_HYDROLOGY_MAP.dwg
 Last Updated: Mar 17, 2022 11:40am by jg098

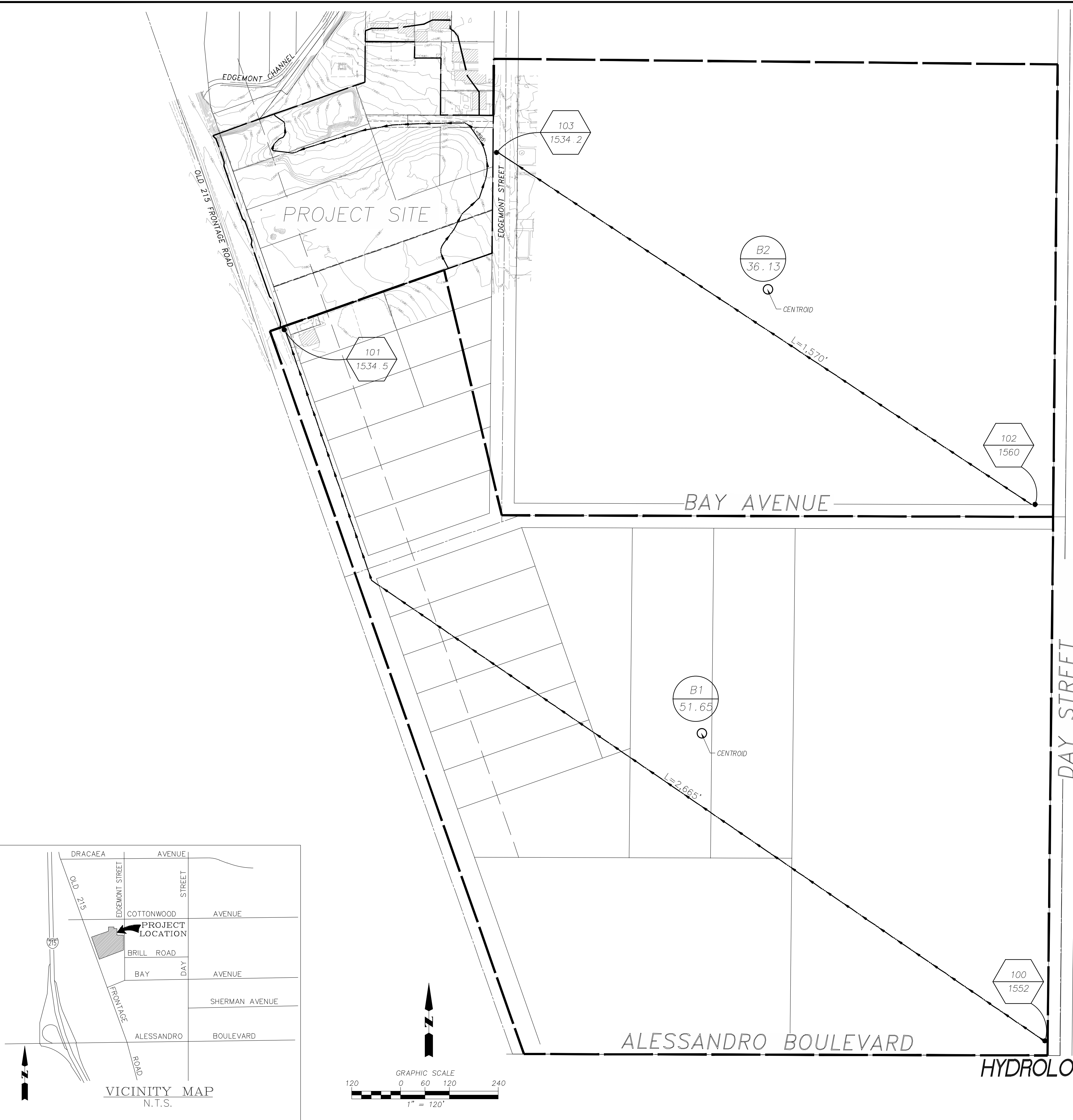

LEGEND

	NODE/CONCENTRATION POINT ELEVATION		FLOW PATH
	SUBAREA ACRES		WATERSHED BOUNDARY
L=XXX'	MAIN FLOW PATH		

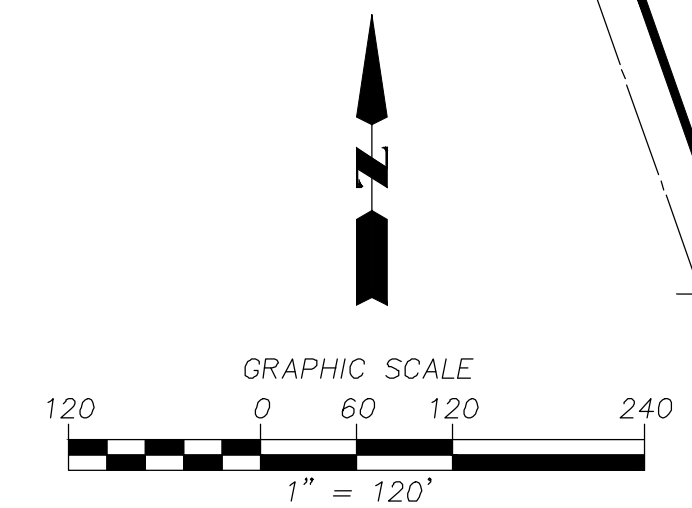
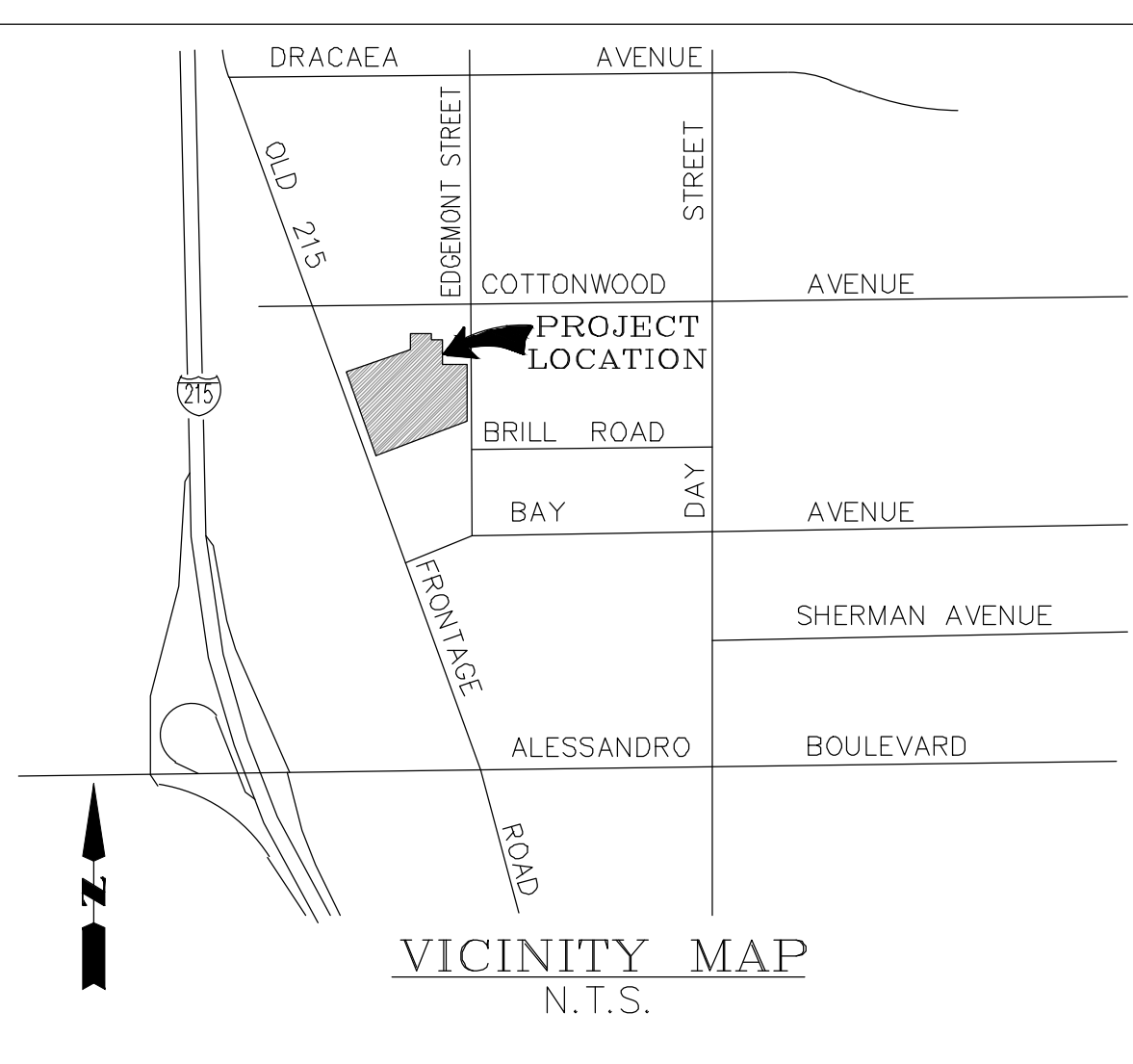

EXHIBIT "C"
UNIT HYDROGRAPH METHOD
HYDROLOGY MAP FOR INDUSTRIAL WAREHOUSES
OFF SITE ANALYSIS

PEN21-0325/LST22-0007

CASC
 Engineering and Consulting
 14701 TAS 000 Y HWY 100 GIL CA 92327
 PH: (909) 783-0101 FAX: (909) 783-0135
 www.casc-engineering.com

Appendix 8: Source Control

Pollutant Sources/Source Control Checklist

STORMWATER POLLUTANT SOURCES/SOURCE CONTROL CHECKLIST

How to use this worksheet (also see instructions in Section G of the WQMP Template):

1. Review Column 1 and identify which of these potential sources of stormwater pollutants apply to your site. Check each box that applies.
2. Review Column 2 and incorporate all of the corresponding applicable BMPs in your WQMP Exhibit.
3. Review Columns 3 and 4 and incorporate all of the corresponding applicable permanent controls and operational BMPs in your WQMP. Use the format shown in Table G.1 on page 23 of this WQMP Template. Describe your specific BMPs in an accompanying narrative, and explain any special conditions or situations that required omitting BMPs or substituting alternative BMPs for those shown here.

IF THESE SOURCES WILL BE ON THE PROJECT SITE THEN YOUR WQMP SHOULD INCLUDE THESE SOURCE CONTROL BMPs, AS APPLICABLE		
1 Potential Sources of Runoff Pollutants	2 Permanent Controls—Show on WQMP Drawings	3 Permanent Controls—List in WQMP Table and Narrative	4 Operational BMPs—Include in WQMP Table and Narrative
<input checked="" type="checkbox"/> A. On-site storm drain inlets	<input checked="" type="checkbox"/> Locations of inlets.	<input checked="" type="checkbox"/> Mark all inlets with the words “Only Rain Down the Storm Drain” or similar. Catch Basin Markers may be available from the Riverside County Flood Control and Water Conservation District, call 951.955.1200 to verify.	<input checked="" type="checkbox"/> Maintain and periodically repaint or replace inlet markings. <input checked="" type="checkbox"/> Provide stormwater pollution prevention information to new site owners, lessees, or operators. <input checked="" type="checkbox"/> See applicable operational BMPs in Fact Sheet SC-44, “Drainage System Maintenance,” in the CASQA Stormwater Quality Handbooks at www.cabmphandbooks.com <input checked="" type="checkbox"/> Include the following in lease agreements: “Tenant shall not allow anyone to discharge anything to storm drains or to store or deposit materials so as to create a potential discharge to storm drains.”
<input checked="" type="checkbox"/> B. Interior floor drains and elevator shaft sump pumps		<input checked="" type="checkbox"/> State that interior floor drains and elevator shaft sump pumps will be plumbed to sanitary sewer.	<input checked="" type="checkbox"/> Inspect and maintain drains to prevent blockages and overflow.
<input type="checkbox"/> C. Interior parking garages		<input type="checkbox"/> State that parking garage floor drains will be plumbed to the sanitary sewer.	<input type="checkbox"/> Inspect and maintain drains to prevent blockages and overflow.

STORMWATER POLLUTANT SOURCES/SOURCE CONTROL CHECKLIST

IF THESE SOURCES WILL BE ON THE PROJECT SITE THEN YOUR WQMP SHOULD INCLUDE THESE SOURCE CONTROL BMPs, AS APPLICABLE		
1 Potential Sources of Runoff Pollutants	2 Permanent Controls—Show on WQMP Drawings	3 Permanent Controls—List in WQMP Table and Narrative	4 Operational BMPs—Include in WQMP Table and Narrative
<input type="checkbox"/> D1. Need for future indoor & structural pest control		<input type="checkbox"/> Note building design features that discourage entry of pests.	<input type="checkbox"/> Provide Integrated Pest Management information to owners, lessees, and operators.
<input checked="" type="checkbox"/> D2. Landscape/ Outdoor Pesticide Use	<input type="checkbox"/> Show locations of native trees or areas of shrubs and ground cover to be undisturbed and retained. <input checked="" type="checkbox"/> Show self-retaining landscape areas, if any. <input checked="" type="checkbox"/> Show stormwater treatment and hydrograph modification management BMPs. (See instructions in Chapter 3, Step 5 and guidance in Chapter 5.)	<p>State that final landscape plans will accomplish all of the following.</p> <input type="checkbox"/> Preserve existing native trees, shrubs, and ground cover to the maximum extent possible. <input checked="" type="checkbox"/> Design landscaping to minimize irrigation and runoff, to promote surface infiltration where appropriate, and to minimize the use of fertilizers and pesticides that can contribute to stormwater pollution. <input type="checkbox"/> Where landscaped areas are used to retain or detain stormwater, specify plants that are tolerant of saturated soil conditions. <input checked="" type="checkbox"/> Consider using pest-resistant plants, especially adjacent to hardscape. <p>To insure successful establishment, select plants appropriate to site soils, slopes, climate, sun, wind, rain, land use, air movement, ecological consistency, and plant interactions.</p>	<input type="checkbox"/> Maintain landscaping using minimum or no pesticides. <input type="checkbox"/> See applicable operational BMPs in “What you should know for.....Landscape and Gardening” at http://rcflood.org/stormwater/Error! <small>Hyperlink reference not valid.</small> <input type="checkbox"/> Provide IPM information to new owners, lessees and operators.

STORMWATER POLLUTANT SOURCES/SOURCE CONTROL CHECKLIST

IF THESE SOURCES WILL BE ON THE PROJECT SITE THEN YOUR WQMP SHOULD INCLUDE THESE SOURCE CONTROL BMPs, AS APPLICABLE		
1 Potential Sources of Runoff Pollutants	2 Permanent Controls—Show on WQMP Drawings	3 Permanent Controls—List in WQMP Table and Narrative	4 Operational BMPs—Include in WQMP Table and Narrative
<input type="checkbox"/> E. Pools, spas, ponds, decorative fountains, and other water features.	<input type="checkbox"/> Show location of water feature and a sanitary sewer cleanout in an accessible area within 10 feet. (Exception: Public pools must be plumbed according to County Department of Environmental Health Guidelines.)	If the Co-Permittee requires pools to be plumbed to the sanitary sewer, place a note on the plans and state in the narrative that this connection will be made according to local requirements.	<input type="checkbox"/> See applicable operational BMPs in “Guidelines for Maintaining Your Swimming Pool, Jacuzzi and Garden Fountain” at http://rcflood.org/stormwater/
<input type="checkbox"/> F. Food service	<input type="checkbox"/> For restaurants, grocery stores, and other food service operations, show location (indoors or in a covered area outdoors) of a floor sink or other area for cleaning floor mats, containers, and equipment. <input type="checkbox"/> On the drawing, show a note that this drain will be connected to a grease interceptor before discharging to the sanitary sewer.	<input type="checkbox"/> Describe the location and features of the designated cleaning area. <input type="checkbox"/> Describe the items to be cleaned in this facility and how it has been sized to insure that the largest items can be accommodated.	<input type="checkbox"/> See the brochure, “The Food Service Industry Best Management Practices for: Restaurants, Grocery Stores, Delicatessens and Bakeries” at http://rcflood.org/stormwater/ Provide this brochure to new site owners, lessees, and operators.
<input checked="" type="checkbox"/> G. Refuse areas	<input type="checkbox"/> Show where site refuse and recycled materials will be handled and stored for pickup. See local municipal requirements for sizes and other details of refuse areas. <input type="checkbox"/> If dumpsters or other receptacles are outdoors, show how the designated area will be covered, graded, and paved to prevent run-on and show locations of berms to prevent runoff from the area. <input type="checkbox"/> Any drains from dumpsters, compactors, and tallow bin areas shall be connected to a grease removal device before discharge to sanitary sewer.	<input type="checkbox"/> State how site refuse will be handled and provide supporting detail to what is shown on plans. <input type="checkbox"/> State that signs will be posted on or near dumpsters with the words “Do not dump hazardous materials here” or similar.	<input type="checkbox"/> State how the following will be implemented: Provide adequate number of receptacles. Inspect receptacles regularly; repair or replace leaky receptacles. Keep receptacles covered. Prohibit/prevent dumping of liquid or hazardous wastes. Post “no hazardous materials” signs. Inspect and pick up litter daily and clean up spills immediately. Keep spill control materials available on-site. See Fact Sheet SC-34, “Waste Handling and Disposal” in the CASQA Stormwater Quality Handbooks at www.cabmphandbooks.com

STORMWATER POLLUTANT SOURCES/SOURCE CONTROL CHECKLIST

IF THESE SOURCES WILL BE ON THE PROJECT SITE THEN YOUR WQMP SHOULD INCLUDE THESE SOURCE CONTROL BMPs, AS APPLICABLE		
1 Potential Sources of Runoff Pollutants	2 Permanent Controls—Show on WQMP Drawings	3 Permanent Controls—List in WQMP Table and Narrative	4 Operational BMPs—Include in WQMP Table and Narrative
<input checked="" type="checkbox"/> H. Industrial processes.	<input type="checkbox"/> Show process area.	<input type="checkbox"/> If industrial processes are to be located on site, state: “All process activities to be performed indoors. No processes to drain to exterior or to storm drain system.”	<input type="checkbox"/> See Fact Sheet SC-10, “Non-Stormwater Discharges” in the CASQA Stormwater Quality Handbooks at www.cabmphandbooks.com See the brochure “Industrial & Commercial Facilities Best Management Practices for: Industrial, Commercial Facilities” at http://rcflood.org/stormwater/

STORMWATER POLLUTANT SOURCES/SOURCE CONTROL CHECKLIST

IF THESE SOURCES WILL BE ON THE PROJECT SITE THEN YOUR WQMP SHOULD INCLUDE THESE SOURCE CONTROL BMPs, AS APPLICABLE		
1 Potential Sources of Runoff Pollutants	2 Permanent Controls—Show on WQMP Drawings	3 Permanent Controls—List in WQMP Table and Narrative	4 Operational BMPs—Include in WQMP Table and Narrative
<p><input type="checkbox"/> I. Outdoor storage of equipment or materials. (See rows J and K for source control measures for vehicle cleaning, repair, and maintenance.)</p>	<p><input type="checkbox"/> Show any outdoor storage areas, including how materials will be covered. Show how areas will be graded and bermed to prevent run-on or run-off from area.</p> <p><input type="checkbox"/> Storage of non-hazardous liquids shall be covered by a roof and/or drain to the sanitary sewer system, and be contained by berms, dikes, liners, or vaults.</p> <p><input type="checkbox"/> Storage of hazardous materials and wastes must be in compliance with the local hazardous materials ordinance and a Hazardous Materials Management Plan for the site.</p>	<p>Include a detailed description of materials to be stored, storage areas, and structural features to prevent pollutants from entering storm drains.</p> <p>Where appropriate, reference documentation of compliance with the requirements of Hazardous Materials Programs for:</p> <ul style="list-style-type: none"> ▪ Hazardous Waste Generation ▪ Hazardous Materials Release Response and Inventory ▪ California Accidental Release (CalARP) ▪ Aboveground Storage Tank ▪ Uniform Fire Code Article 80 Section 103(b) & (c) 1991 ▪ Underground Storage Tank <p>www.cchealth.org/groups/hazmat/</p>	<p><input type="checkbox"/> See the Fact Sheets SC-31, “Outdoor Liquid Container Storage” and SC-33, “Outdoor Storage of Raw Materials ” in the CASQA Stormwater Quality Handbooks at www.cabmphandbooks.com</p>

STORMWATER POLLUTANT SOURCES/SOURCE CONTROL CHECKLIST

IF THESE SOURCES WILL BE ON THE PROJECT SITE THEN YOUR WQMP SHOULD INCLUDE THESE SOURCE CONTROL BMPs, AS APPLICABLE		
1 Potential Sources of Runoff Pollutants	2 Permanent Controls—Show on WQMP Drawings	3 Permanent Controls—List in WQMP Table and Narrative	4 Operational BMPs—Include in WQMP Table and Narrative
<input type="checkbox"/> J. Vehicle and Equipment Cleaning	<input type="checkbox"/> Show on drawings as appropriate: (1) Commercial/industrial facilities having vehicle/equipment cleaning needs shall either provide a covered, bermed area for washing activities or discourage vehicle/equipment washing by removing hose bibs and installing signs prohibiting such uses. (2) Multi-dwelling complexes shall have a paved, bermed, and covered car wash area (unless car washing is prohibited on-site and hoses are provided with an automatic shut-off to discourage such use). (3) Washing areas for cars, vehicles, and equipment shall be paved, designed to prevent run-on to or runoff from the area, and plumbed to drain to the sanitary sewer. (4) Commercial car wash facilities shall be designed such that no runoff from the facility is discharged to the storm drain system. Wastewater from the facility shall discharge to the sanitary sewer, or a wastewater reclamation system shall be installed.	<input type="checkbox"/> If a car wash area is not provided, describe any measures taken to discourage on-site car washing and explain how these will be enforced.	Describe operational measures to implement the following (if applicable): <input type="checkbox"/> Washwater from vehicle and equipment washing operations shall not be discharged to the storm drain system. Refer to “Outdoor Cleaning Activities and Professional Mobile Service Providers” for many of the Potential Sources of Runoff Pollutants categories below. Brochure can be found at http://rcflood.org/stormwater/ <input type="checkbox"/> Car dealerships and similar may rinse cars with water only.

STORMWATER POLLUTANT SOURCES/SOURCE CONTROL CHECKLIST

IF THESE SOURCES WILL BE ON THE PROJECT SITE THEN YOUR WQMP SHOULD INCLUDE THESE SOURCE CONTROL BMPs, AS APPLICABLE		
1 Potential Sources of Runoff Pollutants	2 Permanent Controls—Show on WQMP Drawings	3 Permanent Controls—List in WQMP Table and Narrative	4 Operational BMPs—Include in WQMP Table and Narrative
<p><input type="checkbox"/> K. Vehicle/Equipment Repair and Maintenance</p>	<p><input type="checkbox"/> Accommodate all vehicle equipment repair and maintenance indoors. Or designate an outdoor work area and design the area to prevent run-on and runoff of stormwater.</p> <p><input type="checkbox"/> Show secondary containment for exterior work areas where motor oil, brake fluid, gasoline, diesel fuel, radiator fluid, acid-containing batteries or other hazardous materials or hazardous wastes are used or stored. Drains shall not be installed within the secondary containment areas.</p> <p><input type="checkbox"/> Add a note on the plans that states either (1) there are no floor drains, or (2) floor drains are connected to wastewater pretreatment systems prior to discharge to the sanitary sewer and an industrial waste discharge permit will be obtained.</p>	<p><input type="checkbox"/> State that no vehicle repair or maintenance will be done outdoors, or else describe the required features of the outdoor work area.</p> <p><input type="checkbox"/> State that there are no floor drains or if there are floor drains, note the agency from which an industrial waste discharge permit will be obtained and that the design meets that agency’s requirements.</p> <p><input type="checkbox"/> State that there are no tanks, containers or sinks to be used for parts cleaning or rinsing or, if there are, note the agency from which an industrial waste discharge permit will be obtained and that the design meets that agency’s requirements.</p>	<p>In the Stormwater Control Plan, note that all of the following restrictions apply to use the site:</p> <p><input type="checkbox"/> No person shall dispose of, nor permit the disposal, directly or indirectly of vehicle fluids, hazardous materials, or rinsewater from parts cleaning into storm drains.</p> <p><input type="checkbox"/> No vehicle fluid removal shall be performed outside a building, nor on asphalt or ground surfaces, whether inside or outside a building, except in such a manner as to ensure that any spilled fluid will be in an area of secondary containment. Leaking vehicle fluids shall be contained or drained from the vehicle immediately.</p> <p><input type="checkbox"/> No person shall leave unattended drip parts or other open containers containing vehicle fluid, unless such containers are in use or in an area of secondary containment.</p> <p>Refer to “Automotive Maintenance & Car Care Best Management Practices for Auto Body Shops, Auto Repair Shops, Car Dealerships, Gas Stations and Fleet Service Operations”. Brochure can be found at http://rcflood.org/stormwater/</p> <p>Refer to Outdoor Cleaning Activities and Professional Mobile Service Providers for many of the Potential Sources of Runoff Pollutants categories below. Brochure can be found at http://rcflood.org/stormwater/</p>

STORMWATER POLLUTANT SOURCES/SOURCE CONTROL CHECKLIST

IF THESE SOURCES WILL BE ON THE PROJECT SITE THEN YOUR WQMP SHOULD INCLUDE THESE SOURCE CONTROL BMPs, AS APPLICABLE		
1 Potential Sources of Runoff Pollutants	2 Permanent Controls—Show on WQMP Drawings	3 Permanent Controls—List in WQMP Table and Narrative	4 Operational BMPs—Include in WQMP Table and Narrative
<input type="checkbox"/> L. Fuel Dispensing Areas	<input type="checkbox"/> Fueling areas ⁶ shall have impermeable floors (i.e., portland cement concrete or equivalent smooth impervious surface) that are: a) graded at the minimum slope necessary to prevent ponding; and b) separated from the rest of the site by a grade break that prevents run-on of stormwater to the maximum extent practicable. <input type="checkbox"/> Fueling areas shall be covered by a canopy that extends a minimum of ten feet in each direction from each pump. [Alternative: The fueling area must be covered and the cover's minimum dimensions must be equal to or greater than the area within the grade break or fuel dispensing area ¹ .] The canopy [or cover] shall not drain onto the fueling area.		<input type="checkbox"/> The property owner shall dry sweep the fueling area routinely. <input type="checkbox"/> See the Fact Sheet SD-30 , “Fueling Areas” in the CASQA Stormwater Quality Handbooks at www.cabmphandbooks.com

⁶ The fueling area shall be defined as the area extending a minimum of 6.5 feet from the corner of each fuel dispenser or the length at which the hose and nozzle assembly may be operated plus a minimum of one foot, whichever is greater.

STORMWATER POLLUTANT SOURCES/SOURCE CONTROL CHECKLIST

IF THESE SOURCES WILL BE ON THE PROJECT SITE THEN YOUR WQMP SHOULD INCLUDE THESE SOURCE CONTROL BMPs, AS APPLICABLE		
1 Potential Sources of Runoff Pollutants	2 Permanent Controls—Show on WQMP Drawings	3 Permanent Controls—List in WQMP Table and Narrative	4 Operational BMPs—Include in WQMP Table and Narrative
<p><input checked="" type="checkbox"/> M. Loading Docks</p>	<ul style="list-style-type: none"> <input type="checkbox"/> Show a preliminary design for the loading dock area, including roofing and drainage. Loading docks shall be covered and/or graded to minimize run-on to and runoff from the loading area. Roof downspouts shall be positioned to direct stormwater away from the loading area. Water from loading dock areas shall be drained to the sanitary sewer, or diverted and collected for ultimate discharge to the sanitary sewer. <input type="checkbox"/> Loading dock areas draining directly to the sanitary sewer shall be equipped with a spill control valve or equivalent device, which shall be kept closed during periods of operation. <input type="checkbox"/> Provide a roof overhang over the loading area or install door skirts (cowling) at each bay that enclose the end of the trailer. 		<ul style="list-style-type: none"> <input type="checkbox"/> Move loaded and unloaded items indoors as soon as possible. <input type="checkbox"/> See Fact Sheet SC-30, “Outdoor Loading and Unloading,” in the CASQA Stormwater Quality Handbooks at www.cabmphandbooks.com

STORMWATER POLLUTANT SOURCES/SOURCE CONTROL CHECKLIST

IF THESE SOURCES WILL BE ON THE PROJECT SITE THEN YOUR WQMP SHOULD INCLUDE THESE SOURCE CONTROL BMPs, AS APPLICABLE		
1 Potential Sources of Runoff Pollutants	2 Permanent Controls—Show on WQMP Drawings	3 Permanent Controls—List in WQMP Table and Narrative	4 Operational BMPs—Include in WQMP Table and Narrative
<input type="checkbox"/> N. Fire Sprinkler Test Water		<input type="checkbox"/> Provide a means to drain fire sprinkler test water to the sanitary sewer.	<input type="checkbox"/> See the note in Fact Sheet SC-41, “Building and Grounds Maintenance,” in the CASQA Stormwater Quality Handbooks at www.cabmphandbooks.com
<p>O. Miscellaneous Drain or Wash Water or Other Sources</p> <input type="checkbox"/> Boiler drain lines <input checked="" type="checkbox"/> Condensate drain lines <input type="checkbox"/> Rooftop equipment <input type="checkbox"/> Drainage sumps <input checked="" type="checkbox"/> Roofing, gutters, and trim. <input type="checkbox"/> Other sources		<input type="checkbox"/> Boiler drain lines shall be directly or indirectly connected to the sanitary sewer system and may not discharge to the storm drain system. <input checked="" type="checkbox"/> Condensate drain lines may discharge to landscaped areas if the flow is small enough that runoff will not occur. Condensate drain lines may not discharge to the storm drain system. Rooftop equipment with potential to produce pollutants shall be roofed and/or have secondary containment. <input type="checkbox"/> Any drainage sumps on-site shall feature a sediment sump to reduce the quantity of sediment in pumped water. <input checked="" type="checkbox"/> Avoid roofing, gutters, and trim made of copper or other unprotected metals that may leach into runoff. Include controls for other sources as specified by local reviewer.	

STORMWATER POLLUTANT SOURCES/SOURCE CONTROL CHECKLIST

IF THESE SOURCES WILL BE ON THE PROJECT SITE THEN YOUR WQMP SHOULD INCLUDE THESE SOURCE CONTROL BMPs, AS APPLICABLE		
1 Potential Sources of Runoff Pollutants	2 Permanent Controls—Show on WQMP Drawings	3 Permanent Controls—List in WQMP Table and Narrative	4 Operational BMPs—Include in WQMP Table and Narrative
<input checked="" type="checkbox"/> P. Plazas, sidewalks, and parking lots.			<input type="checkbox"/> Sweep plazas, sidewalks, and parking lots regularly to prevent accumulation of litter and debris. Collect debris from pressure washing to prevent entry into the storm drain system. Collect washwater containing any cleaning agent or degreaser and discharge to the sanitary sewer not to a storm drain.

Appendix 9: O&M

Operation and Maintenance Plan and Documentation of Finance, Maintenance and Recording Mechanisms

To be provided at Final Submittal.

Appendix 10: Educational Materials

BMP Fact Sheets, Maintenance Guidelines and Other End-User BMP Information

For Information:

For more information on the General Industrial Storm Water Permit contact:

State Water Resources Control Board (SWRCB)
(916) 657-1146 or www.swrcb.ca.gov/ or, at your
Regional Water Quality Control Board (RWQCB).

Santa Ana Region (8)
California Tower
3737 Main Street, Ste. 500
Riverside, CA 92501-3339
(909) 782-4130

San Diego Region (9)
9771 Clairemont Mesa Blvd., Ste. A
San Diego, CA 92124
(619) 467-2952

Colorado River Basin Region (7)
73-720 Fred Waring Dr., Ste. 100
Palm Desert, CA 92260
(760) 346-7491

SPILL RESPONSE AGENCY:

HAZ-MAT: (909) 358-5055

HAZARDOUS WASTE DISPOSAL: (909) 358-5055

RECYCLING INFORMATION: 1-800-366-SAVE

TO REPORT ILLEGAL DUMPING OR A CLOGGED

STORM DRAIN: 1-800-506-2555

To order additional brochures or to obtain information
on other pollution prevention activities, call:
(909) 955-1111.



Riverside County gratefully acknowledges the State Water Quality Control Board and the American Public Works Association, Storm Water Quality Task Force for the information provided in this brochure.

DID YOU KNOW . . .

YOUR FACILITY MAY NEED A STORM WATER PERMIT?



Many industrial facilities
and manufacturing operations
must obtain coverage under the
Industrial Activities Storm Water
General Permit

**FIND OUT
IF YOUR FACILITY
MUST OBTAIN A PERMIT**

StormWater Pollution . . . What you should know

Riverside County has two drainage systems - sanitary sewers and storm drains. The storm drain system is designed to help prevent flooding by carrying excess rainwater away from streets. Since the storm drain system does not provide for water treatment, it also serves the *unintended* function of transporting pollutants directly to our waterways.

Unlike sanitary sewers, storm drains are not connected to a treatment plant - they flow directly to our local streams, rivers and lakes.

In recent years, awareness of the need to protect water quality has increased. As a result, federal, state, and local programs have been established to reduce polluted stormwater discharges to our waterways. The emphasis of these programs is to prevent stormwater pollution since it's much easier, and less costly, than cleaning up "after the fact."



National Pollutant Discharge Elimination System (NPDES)

In 1987, the Federal Clean Water Act was amended to establish a framework for regulating industrial stormwater discharges under the NPDES permit program. In California, NPDES permits are issued by the State Water Resources Control Board (SWRCB) and the nine (9) Regional Water Quality Control Boards (RWQCB). In general, certain industrial facilities and manufacturing operations must obtain coverage under the Industrial Activities Storm Water General Permit if the type of facilities or operations falls into one of the several categories described in this brochure.

How Do I Know If I Need A Permit?

Following are **general descriptions** of the industry categories types that are regulated by the Industrial Activities Storm Water General Permit. Contact your local Region Water Quality Control Board to determine if your facility/operation requires coverage under the Permit.

→ Facilities such as cement manufacturing; feedlots; fertilizer manufacturing; petroleum refining; phosphate manufacturing; steam electric power generation; coal mining; mineral mining and processing; ore mining and dressing; and asphalt emulsion;

→ Facilities classified as lumber and wood products (except wood kitchen cabinets); pulp, paper, and paperboard mills; chemical producers (except some pharmaceutical and biological products); petroleum and coal products; leather production and products; stone, clay and glass products; primary metal industries; fabricated structural metal; ship and boat building and repairing;

→ Active or inactive mining operations and oil and gas exploration, production, processing, or treatment operations;

→ Hazardous waste treatment, storage, or disposal facilities;

→ Landfills, land application sites and open dumps that receive or have received any industrial waste; unless there is a new overlying land use such as a golf course, park, etc., and there is no discharge associated with the landfill;

→ Facilities involved in the recycling of materials, including metal scrap yards, battery reclaimers, salvage yards, and automobile junkyards;

→ Steam electric power generating facilities, facilities that generate steam for electric power by combustion;

→ Transportation facilities that have vehicle maintenance shops, fueling facilities, equipment cleaning operations, or airport deicing operations. This includes school bus maintenance facilities operated by a school district;

→ Sewage treatment facilities;

→ Facilities that have areas where material handling equipment or activities, raw materials, intermediate products, final products, waste materials, by-products, or industrial machinery are exposed to storm water.

How do I obtain coverage under the Industrial Activities Storm Water General Permit?

Obtain a permit application package from your local Regional Water Quality Control Board listed on the back of this brochure or the State Water Resources Control Board (SWRCB). Submit a completed Notice of Intent (NOI) form, site map and the appropriate fee (\$250 or \$500) to the SWRCB. Facilities must submit an NOI thirty (30) days prior to beginning operation. Once you submit the NOI, the State Board will send you a letter acknowledging receipt of your NOI and will assign your facility a waste discharge identification number (WDID No.). You will also receive an annual fee billing. These billings should roughly coincide with the date the State Board processed your original NOI submittal.

What are the requirements of the Industrial Activities Storm Water General Permit?

The basic requirements of the Permit are:

1. The facility must eliminate any non-stormwater discharges or obtain a separate permit for such discharges.
2. The facility must develop and implement a Storm Water Pollution Prevention Plan (SWPPP). The SWPPP must identify sources of pollutants that may be exposed to stormwater. Once the sources of pollutants have been identified, the facility operator must develop and implement Best Management Practices (BMPs) to minimize or prevent polluted runoff.

Guidance in preparing a SWPPP is available from a document prepared by the California Storm Water Quality Task Force called the California Storm Water Best Management Practice Handbook.

3. The facility must develop and implement a Monitoring Program that includes conducting visual observations and collecting samples of the facility's storm water discharges associated with industrial activity. The General Permit requires that the analysis be conducted by a laboratory that is certified by the State of California.
4. The facility must submit to the Regional Board, every July 1, an annual report that includes the results of its monitoring program.

A Non-Storm Water Discharge is... any discharge to a storm drain system that is not composed entirely of storm water. The following non-storm water discharges are authorized by the General Permit: fire hydrant flushing; potable water sources, including potable water related to the operation, maintenance, or testing of potable water systems; drinking fountain water; atmospheric condensates including refrigeration, air conditioning, and compressor condensate; irrigation drainage; landscape watering; springs; non-contaminated ground water; foundation or footing drainage; and sea water infiltration where the sea waters are discharged back into the sea water source.

A BMP is . . . a technique, process, activity, or structure used to reduce the pollutant content of a storm water discharge. BMPs may include simple, non-structural methods such as good housekeeping, staff training and preventive maintenance. Additionally, BMPs may include structural modifications such as the installation of berms, canopies or treatment control (e.g. setting basins, oil/water separators, etc.)



WARNING: There are significant penalties for non-compliance: a minimum fine of \$5,000 for failing to obtain permit coverage, and, up to \$10,000 per day, per violation plus \$10 per gallon of discharge in excess of 1,000 gallons.



Riverside County Stormwater Program Members

City of Banning
(951) 922-3105

City of Beaumont
(951) 769-8520

City of Calimesa
(909) 795-9801

City of Canyon Lake
(951) 244-2955

City of Cathedral City
(760) 770-0340

City of Coachella
(760) 398-3502

City of Corona
(951) 736-2447

City of Desert Hot Springs
(760) 329-6411

City of Eastvale
(951) 361-0900

City of Hemet
(951) 765-2300

City of Indian Wells
(760) 346-2489

City of Indio
(760) 391-4000

City of Jurupa Valley
(951) 332-6464

City of Lake Elsinore
(951) 674-3124

City of La Quinta
(760) 777-7000

City of Menifee
(951) 672-6777

City of Moreno Valley
(951) 413-3000

City of Murrieta
(951) 304-2489

City of Norco
(951) 270-5607

City of Palm Desert
(760) 346-0611

City of Palm Springs
(760) 323-8299

City of Perris
(951) 943-6100

City of Rancho Mirage
(760) 324-4511

City of Riverside
(951) 826-5311

City of San Jacinto
(951) 487-7330

City of Temecula
(951) 694-6444

City of Wildomar
(951) 677-7751

Coachella Valley Water District
(760) 398-2651

County of Riverside
(951) 955-1000

Riverside County Flood Control District
(951) 955-1200

Stormwater Pollution

What you should know for...

Industrial & Commercial Facilities

Best Management Practices (BMPS) for:

- Industrial Facilities
- Commercial Facilities



YOU can prevent Stormwater Pollution following these practices...

Industrial and Commercial Facilities

The Riverside County Stormwater Program has identified a number of Best Management Practices (BMPs) for Industrial and Commercial Facilities. These BMPs control and reduce stormwater pollutants from reaching our storm drain system and ultimately our local water bodies. City and County ordinances require businesses to use these BMPs to protect our water quality. Local cities and the County are required to verify implementation of these BMPs by performing regular facility inspections.

Prohibited Discharges

Discontinue all non-stormwater discharges to the storm drain system. It is *prohibited* to discharge any chemicals, paints, debris, wastes or wastewater into the gutter, street or storm drain.

Outdoor Storage BMPs

- Install covers and secondary containment areas for all hazardous materials and wastes stored outdoors in accordance with County and/or City standards.
- Keep all temporary waste containers covered, at all times when not in use.
- Sweep outdoor areas instead of using a hose or pressure washer.
- Move all process operations including vehicle/equipment maintenance inside of the building or under a covered and contained area.
- Wash equipment and vehicles in a contained and covered wash bay which is closed-loop or connected to a clarifier sized to local standards and discharged to a sanitary sewer or take them to a commercial car wash.



Spills and Clean Up BMPs

- Keep the work site clean and orderly. Remove debris in a timely fashion. Sweep up the area.
- Clean up spills immediately when they occur, using dry clean up methods such as absorbent materials or sweep followed by proper disposal of materials.

- Always have a spill kit available near chemical loading dock doors and vehicle maintenance and fueling areas.
- Follow your Business Emergency Plan, as filed with the local Fire Department.
- Report all prohibited discharges and non-implementation of BMPs to your local Stormwater Coordinator as listed on the back of this pamphlet.
- Report hazardous materials spills to 951-358-5055 or call after hours to 951-782-2973 or, if an emergency, call the Fire Department's Haz Mat Team at 911.



Plastic Manufacturing Facilities BMPs

AB 258 requires plastic product manufacturers to use BMPs, such as safe storage and clean-up procedures to prevent plastic pellets (nurdles) from entering the waterway. The plastic pellets are released into the environment during transporting, packaging and processing and migrate to waterways through the storm drain system. AB 258 will help protect fish and wildlife from the hazards of plastic pollution.

Training BMPs

As prescribed by your City and County Stormwater Ordinance(s), train employees in spill procedures and prohibit non-stormwater discharges to the storm drain system. Applicable BMP examples can be found at www.cabmphandbooks.com.

Permitting

Stormwater discharges associated with specific categories for industrial facilities are regulated by the State Water Resources Control Board through an Industrial Stormwater General Permit. A copy of this General Permit and application forms are available at: www.waterboards.ca.gov, select stormwater then the industrial quick link.

To report illegal dumping or for more information on stormwater pollution prevention call: 1-800-506-2555 or e-mail us at: fcnpdes@rcflood.org.

Helpful telephone numbers and links:

Riverside County Stormwater Protection Partners	
Flood Control District	(951) 955-1200
County of Riverside	(951) 955-1000
City of Banning	(951) 922-3105
City of Beaumont	(951) 769-8520
City of Calimesa	(909) 795-9801
City of Canyon Lake	(951) 244-2955
Cathedral City	(760) 770-0327
City of Coachella	(760) 398-4978
City of Corona	(951) 736-2447
City of Desert Hot Springs	(760) 329-6411
City of Eastvale	(951) 361-0900
City of Hemet	(951) 765-2300
City of Indian Wells	(760) 346-2489
City of Indio	(760) 391-4000
City of Lake Elsinore	(951) 674-3124
City of La Quinta	(760) 771-7000
City of Menifee	(951) 672-6777
City of Moreno Valley	(951) 413-3000
City of Murrieta	(951) 304-2489
City of Norco	(951) 270-5607
City of Palm Desert	(760) 346-0611
City of Palm Springs	(760) 323-8299
City of Perris	(951) 943-6100
City of Rancho Mirage	(760) 324-4511
City of Riverside	(951) 361-0900
City of San Jacinto	(951) 654-7337
City of Temecula	(951) 694-6444
City of Wildomar	(951) 677-7751

REPORT ILLEGAL STORM DRAIN DISPOSAL

1-800-506-2555 or e-mail us at fcnpdes@rcflood.org

- Riverside County Flood Control and Water Conservation District
www.rcflood.org

Online resources include:

- California Storm Water Quality Association
www.casqa.org
- State Water Resources Control Board
www.waterboards.ca.gov
- Power Washers of North America
www.thepwna.org

Stormwater Pollution

What you should know for...

Outdoor Cleaning Activities and Professional Mobile Service Providers

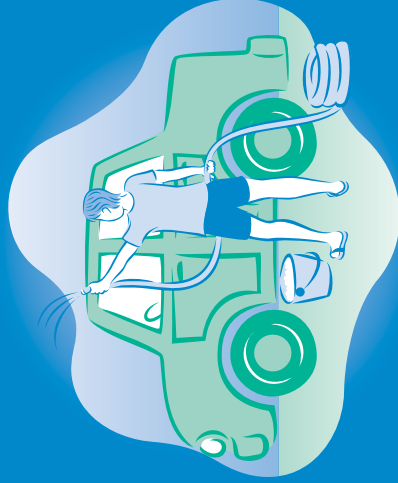

Storm drain pollution prevention information for:

- Car Washing / Mobile Detailers
- Window and Carpet Cleaners
- Power Washers
- Waterproofers / Street Sweepers
- Equipment cleaners or degreasers and all mobile service providers

Do you know where street flows actually go?

Storm drains are NOT connected to sanitary sewer systems and treatment plants!



The primary purpose of storm drains is to carry rain water away from developed areas to prevent flooding. Pollutants discharged to storm drains are transported directly into rivers, lakes and streams. Soaps, degreasers, automotive fluids, litter and a host of materials are washed off buildings, sidewalks, plazas and parking areas. Vehicles and equipment must be properly managed to prevent the pollution of local waterways.

Unintentional spills by mobile service operators can flow into storm drains and pollute our waterways. **Avoid mishaps.** Always have a **Spill Response Kit** on hand to clean up unintentional spills. Only emergency **Mechanical** repairs should be done in City streets, using drip pans for spills. **Plumbing** should be done on private property. Always store chemicals in a leak-proof container and keep covered when not in use. **Window/Power Washing** waste water shouldn't be released into the streets, but should be disposed of in a sanitary sewer, landscaped area or in the soil. Soiled **Carpet Cleaning** wash water should be filtered before being discharged into the sanitary sewer. Dispose of all filter debris properly. **Car Washing/Detailing** operators should wash cars on private property and use a regulated hose nozzle for water flow control and runoff prevention. Capture and dispose of waste water and chemicals properly. Remember, storm drains are for receiving rain water runoff only.

REPORT ILLEGAL STORM DRAIN DISPOSAL
1-800-506-2555



Help Protect Our Waterways!

Use these guidelines for Outdoor Cleaning Activities and Wash Water Disposal

Did you know that disposing of pollutants into the street, gutter, storm drain or body of water is **PROHIBITED** by law and can result in stiff penalties?

Best Management Practices

Waste wash water from Mechanics, Plumbers, Window/Power Washers, Carpet Cleaners, Car Washing and Mobile Detailing activities may contain significant quantities of motor oil, grease, chemicals, dirt, detergents, brake pad dust, litter and other materials.

Best Management Practices, or BMPs as they are known, are guides to prevent pollutants from entering the storm drains. *Each of us* can do our part to keep stormwater clean by using the suggested BMPs below:

Simple solutions for both light and heavy duty jobs:

Do....consider dry cleaning methods first such as a mop, broom, rag or wire brush. Always keep a spill response kit on site.

Do....prepare the work area before power cleaning by using sand bags, rubber mats, vacuum booms, containment pads or temporary berms to keep wash water away from the gutters and storm drains.

Do....use vacuums or other machines to remove and collect loose debris or litter before applying water.

Do....obtain the property owner's permission to dispose of *small amounts* of power washing waste water on to landscaped, gravel or unpaved surfaces.

Do....check your local sanitary sewer agency's policies on wash water disposal regulations before disposing of wash water into the sewer. (See list on reverse side)

Do....be aware that if discharging to landscape areas, soapy wash water may damage landscaping. Residual wash water may remain on paved surfaces to evaporate. Sweep up solid residuals and dispose of properly. Vacuum booms are another option for capturing and collecting wash water.

Do....check to see if local ordinances prevent certain activities.

Do not let...wash or waste water from sidewalk, plaza or building cleaning go into a street or storm drain.



Report illegal storm drain disposal

Call Toll Free

1-800-506-2555

Using Cleaning Agents

Try using biodegradable/phosphate-free products. They are easier on the environment, but don't confuse them with being toxic free. Soapy water entering the storm drain system can impact the delicate aquatic environment.



When cleaning surfaces with a **high-pressure washer** or **steam cleaner**, additional precautions should be taken to prevent the discharge of pollutants into the storm drain system. These two methods of surface cleaning can loosen additional material that can contaminate local waterways.

Think Water Conservation

Minimize water use by using high pressure, low volume nozzles. Be sure to check all hoses for leaks. Water is a precious resource, don't let it flow freely and be sure to shut it off in between uses.

Screening Wash Water

Conduct thorough dry cleanup before washing exterior surfaces, such as buildings and decks **with loose paint**, sidewalks or plaza areas. Keep debris from entering the storm drain after cleaning by first passing the wash water through a "20 mesh" or finer screen to catch the solid materials, then dispose of the mesh in a refuse container. Do not let the remaining wash water enter a street, gutter or storm drain.

Drain Inlet Protection & Collection of Wash Water

- Prior to any washing, block all storm drains with an impervious barrier such as sandbags or berms, or seal the storm drain with plugs or other appropriate materials.
- Create a containment area with berms and traps or take advantage of a low spot to keep wash water contained.
- Wash vehicles and equipment on grassy or gravel areas so that the wash water can seep into the ground.
- Pump or vacuum up all wash water in the contained area.

Concrete/Coring/Saw Cutting and Drilling Projects

Protect any down-gradient inlets by using dry activity techniques whenever possible. If water is used, minimize the amount of water used during the coring/drilling or saw cutting process. Place a barrier of sandbags and/or absorbent berms to protect the storm drain inlet or watercourse. Use a shovel or wet vacuum to remove the residue from the pavement. Do not wash residue or particulate matter into a storm drain inlet or watercourse.



A Citizen's Guide to Understanding Stormwater



United States Environmental Protection Agency

EPA 833-B-03-002

January 2003

Internet Address (URL): <http://www.epa.gov>
Recycled/Recyclable • Printed With Vegetable Oil Based Inks on 100% Postconsumer Process Chlorine Free Recycled Paper



After the Storm

For more information contact:
www.epa.gov/nps/stormwater
or visit
www.epa.gov/nps



What is stormwater runoff?



Stormwater runoff occurs when precipitation from rain or snowmelt flows over the ground. Impervious surfaces like driveways, sidewalks, and streets prevent stormwater from naturally soaking into the ground.

Why is stormwater runoff a problem?



Stormwater can pick up debris, chemicals, dirt, and other pollutants and flow into a storm sewer system or directly to a lake, stream, river, wetland, or coastal water. Anything that enters a storm sewer system is discharged untreated into the waterbodies we use for swimming, fishing, and providing drinking water.

The effects of pollution

Polluted stormwater runoff can have many adverse effects on plants, fish, animals, and people.



- ◆ Sediment can cloud the water and make it difficult or impossible for aquatic plants to grow. Sediment also can destroy aquatic habitats.
- ◆ Excess nutrients can cause algae blooms. When algae die, they sink to the bottom and decompose in a process that removes oxygen from the water. Fish and other aquatic organisms can't exist in water with low dissolved oxygen levels.
- ◆ Bacteria and other pathogens can wash into swimming areas and create health hazards, often making beach closures necessary.
- ◆ Debris—plastic bags, six-pack rings, bottles, and cigarette butts—washed into waterbodies can choke, suffocate, or disable aquatic life like ducks, fish, turtles, and birds.
- ◆ Household hazardous wastes like insecticides, pesticides, paint, solvents, used motor oil, and other auto fluids can poison aquatic life. Land animals and people can become sick or die from eating diseased fish and shellfish or ingesting polluted water.



◆ Polluted stormwater often affects drinking water sources. This, in turn, can affect human health and increase drinking water treatment costs.



Stormwater Pollution Solutions

Residential

Recycle or properly dispose of household products that contain chemicals, such as insecticides, pesticides, paint, solvents, and used motor oil and other auto fluids. Don't pour them onto the ground or into storm drains.

Lawn care

Excess fertilizers and pesticides applied to lawns and gardens wash off and pollute streams. In addition, yard clippings and leaves can wash into storm drains and contribute nutrients and organic matter to streams.



- ◆ Don't overwater your lawn. Consider using a soaker hose instead of a sprinkler.
- ◆ Use pesticides and fertilizers sparingly. When use is necessary, use these chemicals in the recommended amounts. Use organic mulch or safer pest control methods whenever possible.
- ◆ Compost or mulch yard waste. Don't leave it in the street or sweep it into storm drains or streams.
- ◆ Cover piles of dirt or mulch being used in landscaping projects.

Septic systems

Leaking and poorly maintained septic systems release nutrients and pathogens (bacteria and viruses) that can be picked up by stormwater and discharged into nearby waterbodies. Pathogens can cause public health problems and environmental concerns.



- ◆ Inspect your system every 3 years and pump your tank as necessary (every 3 to 5 years).
- ◆ Don't dispose of household hazardous waste in sinks or toilets.

Auto care

Washing your car and degreasing auto parts at home can send detergents and other contaminants through the storm sewer system. Dumping automotive fluids into storm drains has the same result as dumping the materials directly into a waterbody.



- ◆ Use a commercial car wash that treats or recycles its wastewater, or wash your car on your yard so the water infiltrates into the ground.
- ◆ Repair leaks and dispose of used auto fluids and batteries at designated drop-off or recycling locations.

Pet waste

Pet waste can be a major source of bacteria and excess nutrients in local waters.



- ◆ When walking your pet, remember to pick up the waste and dispose of it properly. Flushing pet waste is the best disposal method. Leaving pet waste on the ground increases public health risks by allowing harmful bacteria and nutrients to wash into the storm drain and eventually into local waterbodies.



Education is essential to changing people's behavior. Signs and markers near storm drains warn residents that pollutants entering the drains will be carried untreated into a local waterbody.

Residential landscaping

Permeable Pavement—Traditional concrete and asphalt don't allow water to soak into the ground. Instead these surfaces rely on storm drains to divert unwanted water. Permeable pavement systems allow rain and snowmelt to soak through, decreasing stormwater runoff.

Rain Barrels—You can collect rainwater from rooftops in mosquito-proof containers. The water can be used later on lawn or garden areas.



Rain Gardens and Grassy Swales—Specially designed areas planted with native plants can provide natural places for



rainwater to collect and soak into the ground. Rain from rooftop areas or paved areas can be diverted into these areas rather than into storm drains.

Vegetated Filter Strips—Filter strips are areas of native grass or plants created along roadways or streams. They trap the pollutants stormwater picks up as it flows across driveways and streets.

Commercial

Dirt, oil, and debris that collect in parking lots and paved areas can be washed into the storm sewer system and eventually enter local waterbodies.

- ◆ Sweep up litter and debris from sidewalks, driveways and parking lots, especially around storm drains.
- ◆ Cover grease storage and dumpsters and keep them clean to avoid leaks.
- ◆ Report any chemical spill to the local hazardous waste cleanup team. They'll know the best way to keep spills from harming the environment.

Erosion controls that aren't maintained can cause excessive amounts of sediment and debris to be carried into the stormwater system. Construction vehicles can leak fuel, oil, and other harmful fluids that can be picked up by stormwater and deposited into local waterbodies.

- ◆ Divert stormwater away from disturbed or exposed areas of the construction site.
- ◆ Install silt fences, vehicle mud removal areas, vegetative cover, and other sediment and erosion controls and properly maintain them, especially after rainstorms.
- ◆ Prevent soil erosion by minimizing disturbed areas during construction projects, and seed and mulch bare areas as soon as possible.

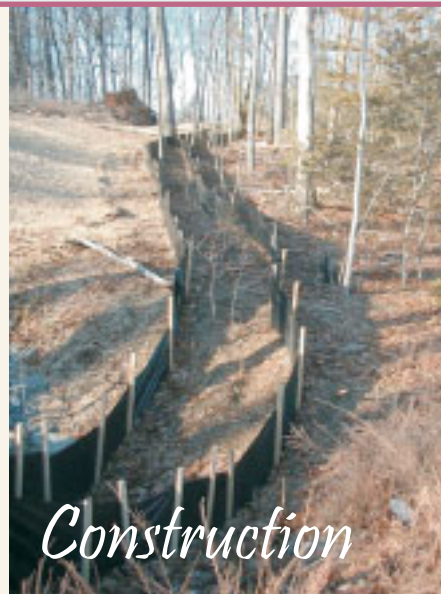

Construction

Agriculture

Lack of vegetation on streambanks can lead to erosion. Overgrazed pastures can also contribute excessive amounts of sediment to local waterbodies. Excess fertilizers and pesticides can poison aquatic animals and lead to destructive algae blooms. Livestock in streams can contaminate waterways with bacteria, making them unsafe for human contact.

- ◆ Keep livestock away from streambanks and provide them a water source away from waterbodies.
- ◆ Store and apply manure away from waterbodies and in accordance with a nutrient management plan.
- ◆ Vegetate riparian areas along waterways.
- ◆ Rotate animal grazing to prevent soil erosion in fields.
- ◆ Apply fertilizers and pesticides according to label instructions to save money and minimize pollution.



Forestry

Improperly managed logging operations can result in erosion and sedimentation.

- ◆ Conduct preharvest planning to prevent erosion and lower costs.
- ◆ Use logging methods and equipment that minimize soil disturbance.
- ◆ Plan and design skid trails, yard areas, and truck access roads to minimize stream crossings and avoid disturbing the forest floor.
- ◆ Construct stream crossings so that they minimize erosion and physical changes to streams.
- ◆ Expedite revegetation of cleared areas.

Automotive Facilities

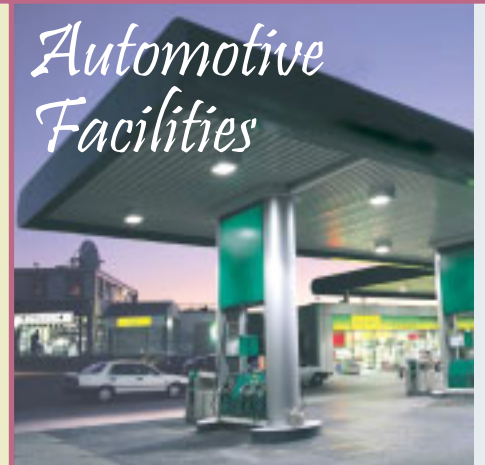

Uncovered fueling stations allow spills to be washed into storm drains. Cars waiting to be repaired can leak fuel, oil, and other harmful fluids that can be picked up by stormwater.

- ◆ Clean up spills immediately and properly dispose of cleanup materials.
- ◆ Provide cover over fueling stations and design or retrofit facilities for spill containment.
- ◆ Properly maintain fleet vehicles to prevent oil, gas, and other discharges from being washed into local waterbodies.
- ◆ Install and maintain oil/water separators.

IRRIGATION RUNOFF

STORMWATER FACT SHEET



RIVERSIDE COUNTY
WATERSHED PROTECTION

Report Irrigation Runoff or Stormwater Pollution:
800.506.2555

OVERWATERING

Overwatering causes irrigation runoff that may contain pollutants such as pesticides, herbicides, fertilizers, pet waste, yard waste, and sediments which can be hazardous to residents and harmful to our environment. Runoff can also serve as a transport mechanism for other pollutants already on the ground or in the curb gutter. Irrigation runoff entering the storm drain system is an illicit discharge.

BEST PRACTICES

Urban runoff begins when yards and landscaped areas are over-irrigated. Irrigation systems require regular maintenance and visual inspection of the system should be performed to prevent over-spray, leaks, and other problems that result in runoff to storm drains, curbs and gutters.

You can **prevent pollution** by conserving water on your property. Water during cooler times of the day (before 10am and after 6pm).

- Adjust sprinklers to stop overspray and runoff.
- Make needed repairs immediately.
- Use drip irrigation, soaker hoses, or micro-spray systems.
- Use an irrigation timer to pre-set watering times.
- Use a control nozzle or similar mechanism when watering by hand.
- Switch to a water-wise landscape - native plants need less fertilizers, herbicides, pesticides and water.

PROTECT OUR WATERSHED

Many people think that when water flows into a storm drain it is treated, but the storm drain system and the sanitary sewer system are not connected. Everything that enters storm drains flows untreated directly into our creeks, rivers, lakes, beaches and ultimately the ocean. Storm water often contains pollutants, including chemicals, trash, and automobile fluids, all of which pollute our watershed and harm fish and wildlife.

Whether at home or work, you can help reduce pollution and improve water quality by using the above Best Management Practices (BMP's) as part of your daily clean up and maintenance routine.



Description

Non-stormwater discharges (NSWDs) are flows that do not consist entirely of stormwater. Some non-stormwater discharges do not include pollutants and may be discharged to the storm drain if local regulations allow. These include uncontaminated groundwater and natural springs. There are also some non-stormwater discharges that typically do not contain pollutants and may be discharged to the storm drain with conditions. These include: potable water sources, fire hydrant flushing, air conditioner condensate, landscape irrigation drainage and landscape watering, emergency firefighting, etc. as discussed in Section 2.

However there are certain non-stormwater discharges that pose an environmental concern. These discharges may originate from illegal dumping of industrial material or wastes and illegal connections such as internal floor drains, appliances, industrial processes, sinks, and toilets that are illegally connected to the nearby storm drainage system through on-site drainage and piping. These unauthorized discharges (examples of which may include: process waste waters, cooling waters, wash waters, and sanitary wastewater) can carry substances such as paint, oil, fuel and other automotive fluids, chemicals and other pollutants into storm drains.

Non-stormwater discharges will need to be addressed through a combination of detection and elimination. The ultimate goal is to effectively eliminate unauthorized non-stormwater discharges to the stormwater drainage system through implementation of measures to detect, correct, and enforce against illicit connections and illegal discharges of

Objectives

- *Cover*
- *Contain*
- *Educate*
- *Reduce/Minimize*
- *Product Substitution*

Targeted Constituents

<i>Sediment</i>	
<i>Nutrients</i>	✓
<i>Trash</i>	
<i>Metals</i>	✓
<i>Bacteria</i>	✓
<i>Oil and Grease</i>	✓
<i>Organics</i>	✓

Minimum BMPs Covered

	<i>Good Housekeeping</i>	✓
	<i>Preventative Maintenance</i>	
	<i>Spill and Leak Prevention and Response</i>	✓
	<i>Material Handling & Waste Management</i>	
	<i>Erosion and Sediment Controls</i>	
	<i>Employee Training Program</i>	✓
	<i>Quality Assurance Record Keeping</i>	✓



pollutants on streets and into the storm drain system and downstream water bodies.

Approach

Initially the Discharger must make an assessment of non-stormwater discharges to determine which types must be eliminated or addressed through BMPs. The focus of the following approach is the elimination of unauthorized non-stormwater discharges. See other BMP Fact Sheets for activity-specific pollution prevention procedures.

General Pollution Prevention Protocols

- Implement waste management controls described in SC-34 Waste Handling and Disposal.
- Develop clear protocols and lines of communication for effectively prohibiting non-stormwater discharges, especially those that are not classified as hazardous. These are often not responded to as effectively as they need to be.
- Stencil or demarcate storm drains, where applicable, to prevent illegal disposal of pollutants. Storm drain inlets should have messages such as “Dump No Waste Drains to Stream” or similar stenciled or demarcated next to them to warn against ignorant or unintentional dumping of pollutants into the storm drainage system.
- Manage and control sources of water such as hose bibs, faucets, wash racks, irrigation heads, etc. Identify hoses and faucets in the SWPPP, and post signage for appropriate use.

Non-Stormwater Discharge Investigation Protocols

Identifying the sources of non-stormwater discharges requires the Discharger to conduct an investigation of the facility at regular intervals. There are several categories of non-stormwater discharges:

- Visible, easily identifiable discharges, typically generated as surface runoff, such as uncontained surface runoff from vehicle or equipment washing; and
- Non-visible, (e.g., subsurface) discharges into the site drainage system through a variety of pathways that are not obvious.

The approach to detecting and eliminating non-stormwater discharges will vary considerably, as discussed below:

Visible and identifiable discharges

- Conduct routine inspections of the facilities and of each major activity area and identify visible evidence of unauthorized non-stormwater discharges. This may include:
 - ✓ Visual observations of actual discharges occurring;

- ✓ Evidence of surface staining, discoloring etc. that indicates that discharges have occurred;
 - ✓ Pools of water in low lying areas when a rain event has not occurred; and
 - ✓ Discussions with operations personnel to understand practices that may lead to unauthorized discharges.
- If evidence of non-stormwater discharges is discovered:
- ✓ Document the location and circumstances using Worksheets 5 and 6 (Section 2 of the manual), including digital photos;
 - ✓ Identify and implement any quick remedy or corrective action (e.g., moving uncovered containers inside or to a proper location); and
 - ✓ Develop a plan to eliminate the discharge. Consult the appropriate activity-specific BMP Fact Sheet for alternative approaches to manage and eliminate the discharge.
- Consult the appropriate activity-specific BMP Fact Sheet for alternative approaches to manage and eliminate the discharge. Make sure the facility SWPPP is up-to-date and includes applicable BMPs to address the non-stormwater discharge.

Other Illegal Discharges (Non visible)

Illicit Connections

- Locate discharges from the industrial storm drainage system to the municipal storm drain system through review of “as-built” piping schematics.
- Isolate problem areas and plug illicit discharge points.
- Locate and evaluate discharges to the storm drain system.
- Visual Inspection and Inventory:
 - ✓ Inventory and inspect each discharge point during dry weather.
 - ✓ Keep in mind that drainage from a storm event can continue for a day or two following the end of a storm and groundwater may infiltrate the underground stormwater collection system.
 - ✓ Non-stormwater discharges are often intermittent and may require periodic inspections.

Review Infield Piping

- A review of the “as-built” piping schematic is a way to determine if there are any connections to the stormwater collection system.

- Inspect the path of loading/unloading area drain inlets and floor drains in older buildings.
- Never assume storm drains are connected to the sanitary sewer system.

Monitoring for investigation/detection of illegal discharges

- If a suspected illegal or unknown discharge is detected, monitoring of the discharge may help identify the content and/or suggest the source. This may be done with a field screening analysis, flow meter measurements, or by collecting a sample for laboratory analysis. Section 5 and Appendix D describe the necessary field equipment and procedures for field investigations.
- Investigative monitoring may be conducted over time. For example if, a discharge is intermittent, then monitoring might be conducted to determine the timing of the discharge to determine the source.
- Investigative monitoring may be conducted over a spatial area. For example, if a discharge is observed in a pipe, then monitoring might be conducted at accessible upstream locations in order to pinpoint the source of the discharge.
- Generally, investigative monitoring requiring collection of samples and submittal for lab analysis requires proper planning and specially trained staff.

Smoke Testing

Smoke testing of wastewater and stormwater collection systems is used to detect connections between the two piping systems. Smoke testing is generally performed at a downstream location and the smoke is forced upstream using blowers to create positive pressure. The advantage to smoke testing is that it can potentially identify multiple potential discharge sources at once.

- Smoke testing uses a harmless, non-toxic smoke cartridges developed specifically for this purpose.
- Smoke testing requires specialized equipment (e.g., cartridges, blowers) and is generally only appropriate for specially trained staff.
- A Standard Operating Procedure (SOP) for smoke testing is highly desirable. The SOP should address the following elements:
 - ✓ Proper planning and notification of nearby residents and emergency services is necessary since introducing smoke into the system may result in false alarms;
 - ✓ During dry weather, the stormwater collection system is filled with smoke and then traced back to sources;

- ✓ Temporary isolation of segments of pipe using sand bags is often needed to force the smoke into leaking pipes; and
- ✓ The appearance of smoke in a waste vent pipe, at a sewer manhole, or even the base of a toilet indicates that there may be a connection between the sanitary and storm water systems.
- Most municipal wastewater agencies will have necessary staff and equipment to conduct smoke testing and they should be contacted if cross connections with the sanitary sewer are suspected. See SC-44 Drainage System Maintenance for more information.

Dye Testing

- Dye testing is typically performed when there is a suspected specific pollutant source and location (i.e., leaking sanitary sewer) and there is evidence of dry weather flows in the stormwater collection system.
- Dye is released at a probable upstream source location, either the facility's sanitary or process wastewater system. The dye must be released with a sufficient volume of water to flush the system.
- Operators then visually examine the downstream discharge points from the stormwater collection system for the presence of the dye.
- Dye testing can be performed informally using commercially available products in order to conduct an initial investigation for fairly obvious cross-connections.
- More detailed dye testing should be performed by properly trained staff and follow SOPs. Specialized equipment such as fluorometers may be necessary to detect low concentrations of dye.
- Most municipal wastewater agencies will have necessary staff and equipment to conduct dye testing and they should be contacted if cross connections with the sanitary sewer are suspected.

TV Inspection of Drainage System

- Closed Circuit Television (CCTV) can be employed to visually identify illicit connections to the industrial storm drainage system. Two types of CCTV systems are available: (1) a small specially designed camera that can be manually pushed on a stiff cable through storm drains to observe the interior of the piping, or (2) a larger remote operated video camera on treads or wheels that can be guided through storm drains to view the interior of the pipe.
- CCTV systems often include a high-pressure water jet and camera on a flexible cable. The water jet cleans debris and biofilm off the inside of pipes so the camera can take video images of the pipe condition.

- CCTV units can detect large cracks and other defects such as offsets in pipe ends caused by root intrusions or shifting substrate.
- CCTV can also be used to detect dye introduced into the sanitary sewer.
- CCTV inspections require specialized equipment and properly trained staff and are generally best left to specialized contractors or municipal public works staff.

Illegal Dumping

- Substances illegally dumped on streets and into the storm drain systems and creeks may include paints, used oil and other automotive fluids, construction debris, chemicals, fresh concrete, leaves, grass clippings, and pet wastes. These wastes can cause stormwater and receiving water quality problems as well as clog the storm drain system itself.
- Establish a system for tracking incidents. The system should be designed to identify the following:
 - ✓ Illegal dumping hot spots;
 - ✓ Types and quantities (in some cases) of wastes;
 - ✓ Patterns in time of occurrence (time of day/night, month, or year);
 - ✓ Mode of dumping (abandoned containers, “midnight dumping” from moving vehicles, direct dumping of materials, accidents/spills);
 - ✓ An anonymous tip/reporting mechanism; and
 - ✓ Evidence of responsible parties (e.g., tagging, encampments, etc.).
- One of the keys to success of reducing or eliminating illegal dumping is increasing the number of people at the facility who are aware of the problem and who have the tools to at least identify the incident, if not correct it. Therefore, train field staff to recognize and report the incidents.

Once a site has been cleaned:

- Post “No Dumping” signs with a phone number for reporting dumping and disposal.
- Landscaping and beautification efforts of hot spots may also discourage future dumping, as well as provide open space and increase property values.
- Lighting or barriers may also be needed to discourage future dumping.
- See fact sheet SC-11 Spill Prevention, Control, and Cleanup.

Inspection

- Regularly inspect and clean up hot spots and other storm drainage areas where illegal dumping and disposal occurs.
- Conduct field investigations of the industrial storm drain system for potential sources of non-stormwater discharges.
- Pro-actively conduct investigations of high priority areas. Based on historical data, prioritize specific geographic areas and/or incident type for pro-active investigations.



Spill and Leak Prevention and Response

- On paved surfaces, clean up spills with as little water as possible. Use a rag for small spills, a damp mop for general cleanup, and absorbent material for larger spills. If the spilled material is hazardous, then the used cleanup materials are also hazardous and must be sent to a certified laundry (rags) or disposed of as hazardous waste.
- Never hose down or bury dry material spills. Sweep up the material and dispose of properly.
- Use adsorbent materials on small spills rather than hosing down the spill. Remove the adsorbent materials promptly and dispose of properly.
- For larger spills, a private spill cleanup company or Hazmat team may be necessary.
- See SC-11 Spill Prevention Control and Cleanup.



Employee Training Program

- Training of technical staff in identifying and documenting illegal dumping incidents is required. The frequency of training must be presented in the SWPPP, and depends on site-specific industrial materials and activities.
- Consider posting a quick reference table near storm drains to reinforce training.
- Train employees to identify non-stormwater discharges and report discharges to the appropriate departments.
- Educate employees about spill prevention and cleanup.
- Well-trained employees can reduce human errors that lead to accidental releases or spills. The employee should have the tools and knowledge to immediately begin cleaning up a spill should one occur. Employees should be familiar with the Spill Prevention Control and Countermeasure Plan. Employees should be able to identify work/jobs with high potential for spills and suggest methods to reduce possibility.
- Determine and implement appropriate outreach efforts to reduce non-permissible non-stormwater discharges.

- Conduct spill response drills annually (if no events occurred) in order to evaluate the effectiveness of the plan.
- When a responsible party is identified, educate the party on the impacts of his or her actions.



Quality Assurance and Record Keeping

Performance Evaluation

- Annually review internal investigation results; assess whether goals were met and what changes or improvements are necessary.
- Obtain feedback from personnel assigned to respond to, or inspect for, illicit connections and illegal dumping incidents.
- Develop document and data management procedures.
- A database is useful for defining and tracking the magnitude and location of the problem.
- Report prohibited non-stormwater discharges observed during the course of normal daily activities so they can be investigated, contained, and cleaned up or eliminated.
- Document that non-stormwater discharges have been eliminated by recording tests performed, methods used, dates of testing, and any on-site drainage points observed.
- Annually document and report the results of the program.
- Maintain documentation of illicit connection and illegal dumping incidents, including significant conditionally exempt discharges that are not properly managed.
- Document training activities.

Potential Limitations and Work-Arounds

Some facilities may have space constraints, limited staffing and time limitations that may preclude implementation of BMPs. Provided below are typical limitations and recommended “work-arounds.”

- Many facilities do not have accurate, up-to-date ‘as-built’ plans or drawings which may be necessary in order to conduct non-stormwater discharge assessments.
 - ✓ Online tools such as Google Earth™ can provide an aerial view of the facility and may be useful in understanding drainage patterns and potential sources of non-stormwater discharges
 - ✓ Local municipal jurisdictions may have useful drainage systems maps.

- Video surveillance cameras are commonly used to secure the perimeter of industrial facilities against break-ins and theft. These surveillance systems may also be useful for capturing illegal dumping activities. Minor, temporary adjustments to the field of view of existing surveillance camera systems to target known or suspected problem areas may be a cost-effective way of capturing illegal dumping activities and identifying the perpetrators.

Potential Capital Facility Costs and Operation & Maintenance Requirements

Facilities

- Capital facility cost requirements may be minimal unless cross-connections to storm drains are detected.
- Indoor floor drains may require re-plumbing if cross-connections are detected.
- Leaky sanitary sewers will require repair or replacement which can have significant costs depending on the size and industrial activity at the facility.

Maintenance (including administrative and staffing)

- The primary effort is for staff time and depends on how aggressively a program is implemented.
- Costs for containment, and disposal of any leak or discharge is borne by the Discharger.
- Illicit connections can be difficult to locate especially if there is groundwater infiltration.
- Illegal dumping and illicit connection violations requires technical staff to detect and investigate them.

Supplemental Information

Permit Requirements

The IGP authorizes certain Non-Storm Water Discharges (NSWDs) provided BMPs are included in the SWPPP and implemented to:

- Reduce or prevent the contact of authorized NSWDs with materials or equipment that are potential sources of pollutants;
- Reduce, to the extent practicable, the flow or volume of authorized NSWDs;
- Ensure that authorized NSWDs do not contain quantities of pollutants that cause or contribute to an exceedance of a water quality standards (WQS); and,

- Reduce or prevent discharges of pollutants in authorized NSWs in a manner that reflects best industry practice considering technological availability and economic practicability and achievability.”

References and Resources

Center for Watershed Protection, 2004. *Illicit Discharge Detection and Elimination: A Guidance Manual for Program Development and Technical Assessments*, EPA Cooperative Agreement X-82907801-0.

Dublin San Ramon Sanitation District. <http://www.dsrsd.com/www/smoketest.html>.

Orange County Stormwater Program, Best Management Practices for Industrial/Commercial Business Activities. Available online at: <http://ocwatersheds.com/documents/bmp/industrialcommercialbusinessesactivities>.

Sacramento Stormwater Management Program, *Best Management Practices for Industrial Storm Water Pollution Control*, Available online at: <http://www.msa.saccounty.net/sactostormwater/documents/guides/industrial-BMP-manual.pdf>.

Santa Clara Valley Urban Runoff Pollution Prevention Program. <http://www.scvurppp.org>.

Southern California Coastal Water Research Project, 2013. *The California Microbial Source Identification Manual: A Tiered Approach to Identifying Fecal Pollution Sources to Beaches*, Technical Report 804.

The Storm Water Managers Resource Center, <http://www.stormwatercenter.net/>.

US EPA. National Pollutant Discharge Elimination System. Available online at: http://cfpub.epa.gov/npdes/stormwater/menuofbmps/index.cfm?action=factsheet_results&view=specific&bmp=111.

WEF Press Alexandria, Virginia, 2009. Existing Sewer Evaluation and Rehabilitation: *WEF Manual of Practice No. FD-6 ASCE/EWRI Manuals and Reports on Engineering Practice No. 62, Third Edition*.

Description

The loading/unloading of materials usually takes place outside on docks or terminals; therefore, materials spilled, leaked, or lost during loading/unloading may collect in the soil or on other surfaces and have the potential to be carried away by wind, stormwater runoff or when the area is cleaned. Additionally, rainfall may wash pollutants from machinery used to unload or move materials. Implementation of the following protocols will prevent or reduce the discharge of pollutants to stormwater from outdoor loading/unloading of materials.

Approach

Reduce potential for pollutant discharge through source control pollution prevention and BMP implementation. Successful implementation depends on effective training of employees on applicable BMPs and general pollution prevention strategies and objectives.

General Pollution Prevention Protocols

- Park tank trucks or delivery vehicles in designated areas so that spills or leaks can be contained.
- Limit exposure of material to rainfall whenever possible.
- Prevent stormwater run-on.
- Check equipment regularly for leaks.



Good Housekeeping

- Develop an operations plan that describes procedures for loading and/or unloading.
- Conduct loading and unloading in dry weather if possible.

Objectives

- Cover
- Contain
- Educate
- Reduce/Minimize
- Product Substitution

Targeted Constituents

Sediment	✓
Nutrients	✓
Trash	
Metals	✓
Bacteria	
Oil and Grease	✓
Organics	✓

Minimum BMPs Covered

 Good Housekeeping	✓
 Preventative Maintenance	
 Spill and Leak Prevention and Response	✓
 Material Handling & Waste Management	✓
 Erosion and Sediment Controls	
 Employee Training Program	✓
 Quality Assurance Record Keeping	✓



- ❑ Cover designated loading/unloading areas to reduce exposure of materials to rain.
- ❑ Consider placing a seal or door skirt between delivery vehicles and building to prevent exposure to rain.
- ❑ Design loading/unloading area to prevent stormwater run-on, which would include grading or berming the area, and position roof downspouts so they direct stormwater away from the loading/unloading areas.
- ❑ Have employees load and unload all materials and equipment in covered areas such as building overhangs at loading docks if feasible.
- ❑ Load/unload only at designated loading areas.
- ❑ Use drip pans underneath hose and pipe connections and other leak-prone spots during liquid transfer operations, and when making and breaking connections. Several drip pans should be stored in a covered location near the liquid transfer area so that they are always available, yet protected from precipitation when not in use. Drip pans can be made specifically for railroad tracks. Drip pans must be cleaned periodically, and drip collected materials must be disposed of properly.
- ❑ Pave loading areas with concrete instead of asphalt.
- ❑ Avoid placing storm drains inlets in the area.
- ❑ Grade and/or berm the loading/unloading area with drainage to sump; regularly remove materials accumulated in sump.



Spill Response and Prevention Procedures

- ❑ Keep your spill prevention and control plan up-to-date or have an emergency spill cleanup plan readily available, as applicable.
- ❑ Contain leaks during transfer.
- ❑ Store and maintain appropriate spill cleanup materials in a location that is readily accessible and known to all employees.
- ❑ Ensure that employees are familiar with the site's spill control plan and proper spill cleanup procedures.
- ❑ Use drip pans or comparable devices when transferring oils, solvents, and paints.



Material Handling and Waste Management

- ❑ Spot clean leaks and drips routinely to prevent runoff of spillage.
- ❑ Do not pour liquid wastes into floor drains, sinks, outdoor storm drain inlets, or other storm drains or sewer connections.

- ❑ Do not put used or leftover cleaning solutions, solvents, and automotive fluids in the storm drain or sanitary sewer.
- ❑ Collect leaking or dripping fluids in drip pans or containers. Fluids are easier to recycle if kept separate.
- ❑ Promptly transfer used fluids to the proper waste or recycling drums. Do not leave drip pans or other open containers lying around.
- ❑ Minimize the possibility of stormwater pollution from outside waste receptacles by doing at least one of the following:
 - ✓ Use only watertight waste receptacle(s) and keep the lid(s) closed.
 - ✓ Grade and pave the waste receptacle area to prevent run-on of stormwater.
 - ✓ Install a roof over the waste receptacle area.
 - ✓ Install a low containment berm around the waste receptacle area.
 - ✓ Use and maintain drip pans under waste receptacles.
- ❑ Post “no littering” signs.
- ❑ Perform work area clean-up and dry sweep after daily operations.



Employee Training Program

- ❑ Train employees (e.g., fork lift operators) and contractors on proper spill containment and cleanup.
- ❑ Have employees trained in spill containment and cleanup present during loading/unloading.
- ❑ Train employees in proper handling techniques during liquid transfers to avoid spills.
- ❑ Make sure forklift operators are properly trained on loading and unloading procedures.



Quality Assurance and Record Keeping

- ❑ Keep accurate maintenance logs that document activities performed, quantities of materials removed, and improvement actions.
- ❑ Keep accurate logs of spill response actions that document what was spilled, how it was cleaned up, and how the waste was disposed.
- ❑ Establish procedures to complete logs and file them in the central office.
- ❑ Keep accurate logs of daily clean-up operations.

Potential Limitations and Work-Arounds

Some facilities may have space constraints, limited staffing and time limitations that may preclude implementation of BMPs. Provided below are typical limitations and recommended “work-arounds.”

- Space and time limitations may preclude all transfers from being performed indoors or under cover.
 - ✓ Designate specific areas for outdoor loading and unloading.
 - ✓ Require employees to understand and follow spill and leak prevention BMPs.
- It may not be possible to conduct transfers only during dry weather.
 - ✓ Limit materials and equipment rainfall exposure to all extents practicable.
 - ✓ Require employees to understand and follow spill and leak prevention BMPs.

Potential Capital Facility Costs and Operation & Maintenance Requirements

Facilities

Many facilities will already have indoor or covered areas where loading/unloading takes place and will require no additional capital expenditures.

If outdoor activities are required, construction of berms or other means to retain spills and leaks may require appropriate constructed systems for containment. These containment areas may require significant new capital investment.

Capital investments will likely be required at some sites if adequate cover and containment facilities do not exist and can vary significantly depending upon site conditions.

Maintenance

Most of the operations and maintenance activities associated with implementing this BMP are integrally linked to routine operations as previously described. Therefore additional O&M is not required.

- Conduct regular inspections and make repairs and improvements as necessary.
- Check loading and unloading equipment regularly for leaks.
- Conduct regular broom dry-sweeping of area. Do not wash with water.

Supplemental Information

Loading and Unloading of Liquids

- Loading or unloading of liquids should occur in the manufacturing building so that any spills that are not completely retained can be discharged to the sanitary sewer,

treatment plant, or treated in a manner consistent with local sewer authorities and permit requirements.

- For loading and unloading tank trucks to above and below ground storage tanks, the following procedures should be used:
 - ✓ The area where the transfer takes place should be paved. If the liquid is reactive with the asphalt, Portland cement should be used to pave the area.
 - ✓ The transfer area should be designed to prevent run-on of stormwater from adjacent areas. Sloping the pad and using a curb, like a speed bump, around the uphill side of the transfer area should reduce run-on.
 - ✓ The transfer area should be designed to prevent runoff of spilled liquids from the area. Sloping the area to a drain should prevent runoff. The drain should be connected to a dead-end sump or to the sanitary sewer. A positive control valve should be installed on the drain.
- For transfer from rail cars to storage tanks that must occur outside, use the following procedures:
 - ✓ Drip pans should be placed at locations where spillage may occur, such as hose connections, hose reels, and filler nozzles. Use drip pans when making and breaking connections.
 - ✓ Drip pan systems should be installed between the rails to collect spillage from tank cars.

References and Resources

Minnesota Pollution Control Agency, *Industrial Stormwater Best Management Practices Guidebook BMP 26 Fueling and Liquid Loading/Unloading Operations*. Available online at: <http://www.pca.state.mn.us/index.php/view-document.html?gid=10557>.

New Jersey Department of Environmental Protection, 2013. *Basic Industrial Stormwater General Permit Guidance Document NJPDES General Permit No NJ0088315*. Available online at: http://www.nj.gov/dep/dwq/pdf/5G2_guidance_color.pdf.

Orange County Stormwater Program, Best Management Practices for Industrial/Commercial Business Activities. Available online at: <http://ocwatersheds.com/documents/bmp/industrialcommercialbusinessesactivities>.

Oregon Department of Environmental Quality, 2013. *Industrial Stormwater Best Management Practices Manual- BMP 26 Fueling and Liquid Loading/Unloading Operations*. Available online at: <http://www.deq.state.or.us/wq/wqpermit/docs/IndBMP021413.pdf>.

Sacramento Stormwater Management Program, *Best Management Practices for Industrial Storm Water Pollution Control*. Available online at: <http://www.msa.saccounty.net/sactostormwater/documents/guides/industrial-BMP-manual.pdf>.

Sacramento County Environmental Management Stormwater Program: *Best Management Practices*. Available online at: <http://www.emd.saccounty.net/EnvHealth/Stormwater/Stormwater-BMPs.html>.

Santa Clara Valley Urban Runoff Pollution Prevention Program. <http://www.scvurppp-w2k.com/>.

US EPA. National Pollutant Discharge Elimination System – Industrial Fact Sheet Series for Activities Covered by EPA’s Multi Sector General Permit. Available online at: <http://cfpub.epa.gov/npdes/stormwater/swsectors.cfm>.

Description

Improper storage and handling of solid wastes can allow toxic compounds, oils and greases, heavy metals, nutrients, suspended solids, and other pollutants to enter stormwater runoff. The discharge of pollutants to stormwater from waste handling and disposal can be prevented and reduced by tracking waste generation, storage, and disposal; reducing waste generation and disposal through source reduction, reuse, and recycling; and preventing run-on and runoff.

Approach

Reduce potential for pollutant discharge through source control pollution prevention and BMP implementation. Successful implementation depends on effective training of employees on applicable BMPs and general pollution prevention strategies and objectives.

General Pollution Prevention Protocols

- Accomplish reduction in the amount of waste generated using the following source controls:
 - ✓ Production planning and sequencing;
 - ✓ Process or equipment modification;
 - ✓ Raw material substitution or elimination;
 - ✓ Loss prevention and housekeeping;
 - ✓ Waste segregation and separation; and
 - ✓ Close loop recycling.
- Establish a material tracking system to increase awareness about material usage. This may reduce spills and minimize contamination, thus reducing the amount of waste produced.
- Recycle materials whenever possible.

Objectives

- Cover
- Contain
- Educate
- Reduce/Minimize
- Product Substitution

Targeted Constituents

Sediment	
Nutrients	
Trash	
Metals	✓
Bacteria	✓
Oil and Grease	✓
Organics	✓

Minimum BMPs Covered

 Good Housekeeping	✓
 Preventative Maintenance	✓
 Spill and Leak Prevention and Response	✓
 Material Handling & Waste Management	✓
 Erosion and Sediment Controls	
 Employee Training Program	✓
 Quality Assurance Record Keeping	✓



- Use the entire product before disposing of the container.
- To the extent possible, store wastes under cover or indoors after ensuring all safety concerns such as fire hazard and ventilation are addressed.
- Provide containers for each waste stream at each work station. Allow time after shift to clean area.



Good Housekeeping

- Cover storage containers with leak proof lids or some other means. If waste is not in containers, cover all waste piles (plastic tarps are acceptable coverage) and prevent stormwater run-on and runoff with a berm. The waste containers or piles must be covered except when in use.
- Use drip pans or absorbent materials whenever grease containers are emptied by vacuum trucks or other means. Grease cannot be left on the ground. Collected grease must be properly disposed of as garbage.
- Dispose of rinse and wash water from cleaning waste containers into a sanitary sewer if allowed by the local sewer authority. Do not discharge wash water to the street or storm drain. Clean in a designated wash area that drains to a clarifier.
- Transfer waste from damaged containers into safe containers.
- Take special care when loading or unloading wastes to minimize losses. Loading systems can be used to minimize spills and fugitive emission losses such as dust or mist. Vacuum transfer systems can minimize waste loss.
- Keep the waste management area clean at all times by sweeping and cleaning up spills immediately.
- Use dry methods when possible (e.g., sweeping, use of absorbents) when cleaning around restaurant/food handling dumpster areas. If water must be used after sweeping/using absorbents, collect water and discharge through grease interceptor to the sewer.
- Stencil or demarcate storm drains on the facility's property with prohibitive message regarding waste disposal.
- Cover waste piles with temporary covering material such as reinforced tarpaulin, polyethylene, polyurethane, polypropylene or hypalon.
- If possible, move the activity indoor after ensuring all safety concerns such as fire hazard and ventilation are addressed.



Preventative Maintenance

- Prevent stormwater run-on from entering the waste management area by enclosing the area or building a berm around the area.
- Prevent waste materials from directly contacting rain.

- ❑ Cover waste piles with temporary covering material such as reinforced tarpaulin, polyethylene, polyurethane, polypropylene or hypalon.
- ❑ Cover the area with a permanent roof if feasible.
- ❑ Cover dumpsters to prevent rain from washing waste out of holes or cracks in the bottom of the dumpster.
- ❑ Check waste containers weekly for leaks and to ensure that lids are on tightly. Replace any that are leaking, corroded, or otherwise deteriorating.
- ❑ Sweep and clean the waste management area regularly. Use dry methods when possible (e.g., sweeping, vacuuming, use of absorbents) when cleaning around restaurant/food handling dumpster areas. If water must be used after sweeping/using absorbents, collect water and discharge through grease interceptor to the sewer.
- ❑ Inspect and replace faulty pumps or hoses regularly to minimize the potential of releases and spills.
- ❑ Repair leaking equipment including valves, lines, seals, or pumps promptly.



Spill Response and Prevention Procedures

- ❑ Keep your spill prevention and plan up-to-date.
- ❑ Have an emergency plan, equipment and trained personnel ready at all times to deal immediately with major spills.
- ❑ Collect all spilled liquids and properly dispose of them.
- ❑ Store and maintain appropriate spill cleanup materials in a location known to all near the designated wash area.
- ❑ Ensure that vehicles transporting waste have spill prevention equipment that can prevent spills during transport. Spill prevention equipment includes:
 - ✓ Vehicles equipped with baffles for liquid waste; and
 - ✓ Trucks with sealed gates and spill guards for solid waste.



Material Handling and Waste Management

Litter Control

- ❑ Post “No Littering” signs and enforce anti-litter laws.
- ❑ Provide a sufficient number of litter receptacles for the facility.
- ❑ Clean out and cover litter receptacles frequently to prevent spillage.

Waste Collection

- ❑ Keep waste collection areas clean.

- Inspect solid waste containers for structural damage regularly. Repair or replace damaged containers as necessary.
- Secure solid waste containers; containers must be closed tightly when not in use.
- Do not fill waste containers with washout water or any other liquid.
- Ensure that only appropriate solid wastes are added to the solid waste container. Certain wastes such as hazardous wastes, appliances, fluorescent lamps, pesticides, etc., may not be disposed of in solid waste containers (see chemical/ hazardous waste collection section below).
- Do not mix wastes; this can cause chemical reactions, make recycling impossible, and complicate disposal. Affix labels to all waste containers.

Chemical/Hazardous Wastes

- Select designated hazardous waste collection areas on-site.
- Store hazardous materials and wastes in covered containers and protect them from vandalism.
- Place hazardous waste containers in secondary containment.
- Make sure that hazardous waste is collected, removed, and disposed of only at authorized disposal areas.
- Hazardous waste cannot be reused or recycled; it must be disposed of by a licensed hazardous waste hauler.



Employee Training Program

- Educate employees about pollution prevention measures and goals.
- Train employees how to properly handle and dispose of waste using the source control BMPs described above.
- Train employees and subcontractors in proper hazardous waste management.
- Use a training log or similar method to document training.
- Ensure that employees are familiar with the site's spill control plan and/or proper spill cleanup procedures.



Quality Assurance and Record Keeping

- Keep accurate maintenance logs that document minimum BMP activities performed for waste handling and disposal, types and quantities of waste disposed of, and any improvement actions.
- Keep accurate logs of spill response actions that document what was spilled, how it was cleaned up, and how the waste was disposed.

- Establish procedures to complete logs and file them in the central office.

Potential Capital Facility Costs and Operation & Maintenance Requirements

Facilities

- Capital costs will vary substantially depending on the size of the facility and the types of waste handled. Significant capital costs may be associated with reducing wastes by modifying processes or implementing closed-loop recycling.
- Many facilities will already have indoor covered areas where waste materials will be stored and will require no additional capital expenditures for providing cover.
- If outdoor storage of wastes is required, construction of berms or other means to prevent stormwater run-on and runoff may require appropriate constructed systems for containment.
- Capital investments will likely be required at some sites if adequate cover and containment facilities do not exist and can vary significantly depending upon site conditions.

Maintenance

- Check waste containers weekly for leaks and to ensure that lids are on tightly. Replace any that are leaking, corroded, or otherwise deteriorating.
- Sweep and clean the waste management area regularly. Use dry methods when possible (e.g., sweeping, use of absorbents) when cleaning around restaurant/food handling dumpster areas. If water must be used after sweeping/using absorbents, collect water and discharge through grease interceptor to the sewer.
- Inspect and replace faulty pumps or hoses regularly to minimize the potential of releases and spills.
- Repair leaking equipment including valves, lines, seals, or pumps promptly.

References and Resources

Minnesota Pollution Control Agency, *Industrial Stormwater Best Management Practices Guidebook*. Available online at: <http://www.pca.state.mn.us/index.php/view-document.html?gid=10557>.

New Jersey Department of Environmental Protection, 2013. *Basic Industrial Stormwater General Permit Guidance Document NJPDES General Permit No NJ0088315*, Revised. Available online at: http://www.nj.gov/dep/dwq/pdf/5G2_guidance_color.pdf.

Orange County Stormwater Program, *Best Management Practices for Industrial/Commercial Business Activities*. Available online at: <http://ocwatersheds.com/documents/bmp/industrialcommercialbusinessesactivities>

Oregon Department of Environmental Quality, 2013. *Industrial Stormwater Best Management Practices Manual- BMP 26 Fueling and Liquid Loading/Unloading Operations*. Available online at:
<http://www.deq.state.or.us/wq/wqpermit/docs/IndBMP021413.pdf>.

Sacramento Stormwater Management Program. *Best Management Practices for Industrial Storm Water Pollution Control*. Available online at:
<http://www.msa.saccounty.net/sactostormwater/documents/guides/industrial-BMP-manual.pdf>.

Sacramento County Environmental Management Stormwater Program: Best Management Practices. Available online at:
<http://www.emd.saccounty.net/EnvHealth/Stormwater/Stormwater-BMPs.html>.

Santa Clara Valley Urban Runoff Pollution Prevention Program. <http://www.scvurppp-w2k.com/>

US EPA. National Pollutant Discharge Elimination System – Industrial Fact Sheet Series for Activities Covered by EPA’s Multi Sector General Permit. Available online at:
<http://cfpub.epa.gov/npdes/stormwater/swsectors.cfm>.

Description

As a consequence of its function, the stormwater drainage facilities on site convey stormwater that may contain certain pollutants either to the offsite conveyance system that collects and transports urban runoff and stormwater, or directly to receiving waters. The protocols in this fact sheet are intended to reduce pollutants leaving the site to the offsite drainage infrastructure or to receiving waters through proper on-site conveyance system operation and maintenance. The targeted constituents will vary depending on site characteristics and operations.

Approach

Successful implementation depends on effective training of employees on applicable BMPs and general pollution prevention strategies and objectives.

General Pollution Prevention Protocols

- Maintain catch basins, stormwater inlets, and other stormwater conveyance structures on a regular basis to remove pollutants, reduce high pollutant concentrations during the first flush of storms, prevent clogging of the downstream conveyance system, restore catch basins' sediment trapping capacity, and ensure the system functions properly hydraulically to avoid flooding.
- Develop and follow a site specific drainage system maintenance plan that describes maintenance locations, methods, required equipment, water sources, sediment collection areas, disposal requirements, and any other pertinent information.



Good Housekeeping

Illicit Connections and Discharges

- Look for evidence of illegal discharges or illicit connections during routine maintenance of conveyance system and drainage structures:

Objectives

- Cover
- Contain
- Educate
- Reduce/Minimize

Targeted Constituents

Sediment	✓
Nutrients	✓
Trash	✓
Metals	✓
Bacteria	✓
Oil and Grease	✓
Organics	✓

Minimum BMPs Covered

	Good Housekeeping	✓
	Preventative Maintenance	✓
	Spill and Leak Prevention and Response	✓
	Material Handling & Waste Management	
	Erosion and Sediment Controls	
	Employee Training Program	✓
	Quality Assurance Record Keeping	✓



CALIFORNIA STORMWATER
QUALITY ASSOCIATION®

Drainage System Maintenance **SC-44**

- ✓ Identify evidence of spills such as paints, discoloring, odors, etc.
- ✓ Record locations of apparent illegal discharges/illicit connections.
- ✓ Track flows back to potential discharges and conduct aboveground inspections. This can be done through visual inspection of upgradient manholes or alternate techniques including zinc chloride smoke testing, fluorometric dye testing, physical inspection testing, or television camera inspection.
- ✓ Eliminate the discharge once the origin of flow is established.
- Stencil or demarcate storm drains, where applicable, to prevent illegal disposal of pollutants. Storm drain inlets should have messages such as “Dump No Waste Drains to Stream” or similar stenciled next to them to warn against ignorant or intentional dumping of pollutants into the storm drainage system.
- Refer to fact sheet SC-10 Non-Stormwater Discharges for additional information.

Illegal Dumping

- Inspect and clean up hot spots and other storm drainage areas regularly where illegal dumping and disposal occurs.
- Establish a system for tracking incidents. The system should be designed to identify the following:
 - ✓ Illegal dumping hot spots;
 - ✓ Types and quantities (in some cases) of wastes;
 - ✓ Patterns in time of occurrence (time of day/night, month, or year);
 - ✓ Mode of dumping (abandoned containers, “midnight dumping” from moving vehicles, direct dumping of materials, accidents/spills); and
 - ✓ Responsible parties.
- Post “No Dumping” signs in problem areas with a phone number for reporting dumping and disposal. Signs should also indicate fines and penalties for illegal dumping.
- Refer to fact sheet SC-10 Non-Stormwater Discharges for additional information.



Preventative Maintenance

Catch Basins/Inlet Structures

- Staff should regularly inspect facilities to ensure compliance with the following:
 - ✓ Immediate repair of any deterioration threatening structural integrity.
 - ✓ Cleaning before the sump is 40% full. Catch basins should be cleaned as frequently as needed to meet this standard.

Drainage System Maintenance **SC-44**

- Clean catch basins, storm drain inlets, and other conveyance structures before the wet season to remove sediments and debris accumulated during the summer.
- Conduct inspections more frequently during the wet season for problem areas where sediment or trash accumulates more often. Prioritize storm drain inlets; clean and repair as needed.
- Keep accurate logs of the number of catch basins cleaned.
- Store wastes collected from cleaning activities of the drainage system in appropriate containers or temporary storage sites in a manner that prevents discharge to the storm drain.
- Dewater the wastes if necessary with outflow into the sanitary sewer if permitted. Water should be treated with an appropriate filtering device prior to discharge to the sanitary sewer. If discharge to the sanitary sewer is not allowed, water should be pumped or vacuumed to a tank and properly disposed. Do not dewater near a storm drain or stream.

Storm Drain Conveyance System

- Locate reaches of storm drain with deposit problems and develop a flushing schedule that keeps the pipe clear of excessive buildup.
- Collect and pump flushed effluent to the sanitary sewer for treatment whenever possible.

Pump Stations

- Clean all storm drain pump stations prior to the wet season to remove silt and trash.
- Do not allow discharge to reach the storm drain system when cleaning a storm drain pump station or other facility.
- Conduct routine maintenance at each pump station.
- Inspect, clean, and repair as necessary all outlet structures prior to the wet season.

Open Channel

- Modify storm channel characteristics to improve channel hydraulics, increase pollutant removals, and enhance channel/creek aesthetic and habitat value.
- Conduct channel modification/improvement in accordance with existing laws. Any person, government agency, or public utility proposing an activity that will change the natural state of any river, stream, or lake in California, must enter into a Stream or Lake Alteration Agreement with the Department of Fish and Wildlife. The developer-applicant should also contact local governments (city, county, special districts), other state agencies (SWRCB, RWQCB, Department of Forestry, Department of Water Resources), and Army Corps of Engineers and USFWS.



Spill Response and Prevention Procedures

- Keep your spill prevention control plan up-to-date.

Drainage System Maintenance **SC-44**

- Investigate all reports of spills, leaks, and/or illegal dumping promptly.
- Place a stockpile of spill cleanup materials where it will be readily accessible or at a central location.
- Clean up all spills and leaks using “dry” methods (with absorbent materials and/or rags) or dig up, remove, and properly dispose of contaminated soil.



Employee Training Program

- Educate employees about pollution prevention measures and goals.
- Train employees how to properly handle and dispose of waste using the source control BMPs described above.
- Train employees and subcontractors in proper hazardous waste management.
- Use a training log or similar method to document training.
- Ensure that employees are familiar with the site’s spill control plan and/or proper spill cleanup procedures.
- Have staff involved in detection and removal of illicit connections trained in the following:
 - ✓ OSHA-required Health and Safety Training (29 CFR 1910.120) plus annual refresher training (as needed).
 - ✓ OSHA Confined Space Entry training (Cal-OSHA Confined Space, Title 8 and Federal OSHA 29 CFR 1910.146).
 - ✓ Procedural training (field screening, sampling, smoke/dye testing, TV inspection).



Quality Assurance and Record Keeping

- Keep accurate maintenance logs that document minimum BMP activities performed for drainage system maintenance, types and quantities of waste disposed of, and any improvement actions.
- Keep accurate logs of spill response actions that document what was spilled, how it was cleaned up, and how the waste was disposed.
- Keep accurate logs of illicit connections, illicit discharges, and illegal dumping into the storm drain system including how wastes were cleaned up and disposed.
- Establish procedures to complete logs and file them in the central office.

Potential Limitations and Work-Arounds

Provided below are typical limitations and recommended “work-arounds” for drainage system maintenance:

Drainage System Maintenance SC-44

- Clean-up activities may create a slight disturbance for local aquatic species. Access to items and material on private property may be limited. Trade-offs may exist between channel hydraulics and water quality/riparian habitat. If storm channels or basins are recognized as wetlands, many activities, including maintenance, may be subject to regulation and permitting.
 - ✓ Perform all maintenance onsite and do not flush accumulated material downstream to private property or riparian habitats.
- Storm drain flushing is most effective in small diameter pipes (36-inch diameter pipe or less, depending on water supply and sediment collection capacity). Other considerations associated with storm drain flushing may include the availability of a water source, finding a downstream area to collect sediments, and liquid/sediment disposal.
 - ✓ Develop and follow a site specific drainage system maintenance plan that describes maintenance locations, methods, required equipment, water sources, sediment collection areas, disposal requirements, and any other pertinent information.
- Regulations may include adoption of substantial penalties for illegal dumping and disposal.
 - ✓ Do not dump illegal materials anywhere onsite.
 - ✓ Identify illicit connections, illicit discharge, and illegal dumping.
 - ✓ Cleanup spills immediately and properly dispose of wastes.
- Local municipal codes may include sections prohibiting discharge of soil, debris, refuse, hazardous wastes, and other pollutants into the sanitary sewer system.
 - ✓ Collect all materials and pollutants accumulated in drainage system and dispose of according to local regulations.
 - ✓ Install debris excluders in areas with a trash TMDL.

Potential Capital Facility Costs and Operation & Maintenance Requirements

Facilities

- Capital costs will vary substantially depending on the size of the facility and characteristics of the drainage system. Significant capital costs may be associated with purchasing water trucks, vacuum trucks, and any other necessary cleaning equipment or improving the drainage infrastructure to reduce the potential .
- Developing and implementing a site specific drainage system maintenance plan will require additional capital if a similar program is not already in place.

Maintenance

- Two-person teams may be required to clean catch basins with vacuum trucks.
- Teams of at least two people plus administrative personnel are required to identify illicit discharges, depending on the complexity of the storm sewer system.
- Arrangements must be made for proper disposal of collected wastes.
- Technical staff are required to detect and investigate illegal dumping violations.
- Methods used for illicit connection detection (smoke testing, dye testing, visual inspection, and flow monitoring) can be costly and time-consuming. Site-specific factors, such as the level of impervious area, the density and ages of buildings, and type of land use will determine the level of investigation necessary.

Supplemental Information

Storm Drain Flushing

Flushing is a common maintenance activity used to improve pipe hydraulics and to remove pollutants in storm drainage systems. Flushing may be designed to hydraulically convey accumulated material to strategic locations, such as an open channel, another point where flushing will be initiated, or the sanitary sewer and the treatment facilities, thus preventing re-suspension and overflow of a portion of the solids during storm events. Flushing prevents “plug flow” discharges of concentrated pollutant loadings and sediments. Deposits can hinder the designed conveyance capacity of the storm drain system and potentially cause backwater conditions in severe cases of clogging.

Storm drain flushing usually takes place along segments of pipe with grades that are too flat to maintain adequate velocity to keep particles in suspension. An upstream manhole is selected to place an inflatable device that temporarily plugs the pipe. Further upstream, water is pumped into the line to create a flushing wave. When the upstream reach of pipe is sufficiently full to cause a flushing wave, the inflated device is rapidly deflated with the assistance of a vacuum pump, thereby releasing the backed up water and resulting in the cleaning of the storm drain segment.

To further reduce impacts of stormwater pollution, a second inflatable device placed well downstream may be used to recollect the water after the force of the flushing wave has dissipated. A pump may then be used to transfer the water and accumulated material to the sanitary sewer for treatment. In some cases, an interceptor structure may be more practical or required to recollect the flushed waters.

It has been found that cleansing efficiency of periodic flush waves is dependent upon flush volume, flush discharge rate, sewer slope, sewer length, sewer flow rate, sewer diameter, and population density. As a rule of thumb, the length of line to be flushed should not exceed 700 feet. At this maximum recommended length, the percent removal efficiency ranges between 65-75% for organics and 55-65% for dry weather grit/inorganic material. The percent removal efficiency drops rapidly beyond that. Water is commonly supplied by a water truck, but fire hydrants can also supply water. To make the best use of water, it is recommended that reclaimed water be used if allowed or that fire hydrant line flushing coincide with storm sewer flushing.

Drainage System Maintenance SC-44

References and Resources

City of Seattle, Seattle Public Utilities Department of Planning and Development, 2009. *Stormwater Manual Vol. 1 Source Control Technical Requirements Manual*.

Knox County Tennessee *Stormwater Management Manual* Chapter 5 Drainage System Maintenance, 2008. Available online at:
http://www.knoxcounty.org/stormwater/manual/Volume%201/knoxco_swmm_v1_chapter5_jan2008.pdf.

US EPA. Storm Drain System Cleaning, 2012. Available online at:
<http://cfpub.epa.gov/npdes/stormwater/menuofbmps/index.cfm?action=browse&Rbutton=detail&bmp=102>.



Objectives

- Cover
- Contain
- Educate
- Reduce/Minimize
- Product Substitution

Description

Pollutants on sidewalks and other pedestrian traffic areas and plazas are typically due to littering and vehicle use. This fact sheet describes good housekeeping practices that can be incorporated into the municipality's existing cleaning and maintenance program.

Approach

Pollution Prevention

- Use dry cleaning methods whenever practical for surface cleaning activities.
- Use the least toxic materials available (e.g. water based paints, gels or sprays for graffiti removal).

Suggested Protocols

Surface Cleaning

- Regularly broom (dry) sweep sidewalk, plaza and parking lot areas to minimize cleaning with water.
- Dry cleanup first (sweep, collect, and dispose of debris and trash) when cleaning sidewalks or plazas, then wash with or without soap.
- Block the storm drain or contain runoff when cleaning with water. Discharge wash water to landscaping or collect water and pump to a tank or discharge to sanitary sewer if allowed. (Permission may be required from local sanitation district.)

Targeted Constituents

Sediment	<input checked="" type="checkbox"/>
Nutrients	<input checked="" type="checkbox"/>
Trash	<input checked="" type="checkbox"/>
Metals	<input checked="" type="checkbox"/>
Bacteria	<input checked="" type="checkbox"/>
Oil and Grease	<input checked="" type="checkbox"/>
Organics	<input checked="" type="checkbox"/>
Oxygen Demanding	<input checked="" type="checkbox"/>



- Block the storm drain or contain runoff when washing parking areas, driveways or drive-throughs. Use absorbents to pick up oil; then dry sweep. Clean with or without soap. Collect water and pump to a tank or discharge to sanitary sewer if allowed. Street Repair and Maintenance.

Graffiti Removal

- Avoid graffiti abatement activities during rain events.
- Implement the procedures under Painting and Paint Removal in SC-70 Roads, Streets, and Highway Operation and Maintenance fact sheet when graffiti is removed by painting over.
- Direct runoff from sand blasting and high pressure washing (with no cleaning agents) into a dirt or landscaped area after treating with an appropriate filtering device.
- Plug nearby storm drain inlets and vacuum/pump wash water to the sanitary sewer if authorized to do so if a graffiti abatement method generates wash water containing a cleaning compound (such as high pressure washing with a cleaning compound). Ensure that a non-hazardous cleaning compound is used or dispose as hazardous waste, as appropriate.

Surface Removal and Repair

- Schedule surface removal activities for dry weather if possible.
- Avoid creating excess dust when breaking asphalt or concrete.
- Take measures to protect nearby storm drain inlets prior to breaking up asphalt or concrete (e.g. place hay bales or sand bags around inlets). Clean afterwards by sweeping up as much material as possible.
- Designate an area for clean up and proper disposal of excess materials.
- Remove and recycle as much of the broken pavement as possible to avoid contact with rainfall and stormwater runoff.
- When making saw cuts in pavement, use as little water as possible. Cover each storm drain inlet completely with filter fabric during the sawing operation and contain the slurry by placing straw bales, sandbags, or gravel dams around the inlets. After the liquid drains or evaporates, shovel or vacuum the slurry residue from the pavement or gutter and remove from site.
- Always dry sweep first to clean up tracked dirt. Use a street sweeper or vacuum truck. Do not dump vacuumed liquid in storm drains. Once dry sweeping is complete, the area may be hosed down if needed. Wash water should be directed to landscaping or collected and pumped to the sanitary sewer if allowed.

Concrete Installation and Repair

- Schedule asphalt and concrete activities for dry weather.

- Take measures to protect any nearby storm drain inlets and adjacent watercourses, prior to breaking up asphalt or concrete (e.g. place sand bags around inlets or work areas).
- Limit the amount of fresh concrete or cement mortar mixed, mix only what is needed for the job.
- Store concrete materials under cover, away from drainage areas. Secure bags of cement after they are open. Be sure to keep wind-blown cement powder away from streets, gutters, storm drains, rainfall, and runoff.
- Return leftover materials to the transit mixer. Dispose of small amounts of hardened excess concrete, grout, and mortar in the trash.
- Do not wash sweepings from exposed aggregate concrete into the street or storm drain. Collect and return sweepings to aggregate base stockpile, or dispose in the trash.
- Protect applications of fresh concrete from rainfall and runoff until the material has dried.
- Do not allow excess concrete to be dumped onsite, except in designated areas.
- Wash concrete trucks off site or in designated areas on site designed to preclude discharge of wash water to drainage system.

Controlling Litter

- Post “No Littering” signs and enforce anti-litter laws.
- Provide litter receptacles in busy, high pedestrian traffic areas of the community, at recreational facilities, and at community events.
- Cover litter receptacles and clean out frequently to prevent leaking/spillage or overflow.
- Clean parking lots on a regular basis with a street sweeper.

Training

- Provide regular training to field employees and/or contractors regarding surface cleaning and proper operation of equipment.
- Train employee and contractors in proper techniques for spill containment and cleanup.
- Use a training log or similar method to document training.

Spill Response and Prevention

- Refer to SC-11, Spill Prevention, Control & Cleanup.
- Have spill cleanup materials readily available and in a known location.
- Cleanup spills immediately and use dry methods if possible.
- Properly dispose of spill cleanup material.

Other Considerations

- Limitations related to sweeping activities at large parking facilities may include current sweeper technology to remove oil and grease.
- Surface cleaning activities that require discharges to the local sewerage agency will require coordination with the agency.
- Arrangements for disposal of the swept material collected must be made, as well as accurate tracking of the areas swept and the frequency of sweeping.

Requirements***Costs***

- The largest expenditures for sweeping and cleaning of sidewalks, plazas, and parking lots are in staffing and equipment. Sweeping of these areas should be incorporated into street sweeping programs to reduce costs.

Maintenance

Not applicable

Supplemental Information***Further Detail of the BMP***

Community education, such as informing residents about their options for recycling and waste disposal, as well as the consequences of littering, can instill a sense of citizen responsibility and potentially reduce the amount of maintenance required by the municipality.

Additional BMPs that should be considered for parking lot areas include:

- Allow sheet runoff to flow into biofilters (vegetated strip and swale) and infiltration devices.
- Utilize sand filters or oleophilic collectors for oily waste in low concentrations.
- Arrange rooftop drains to prevent drainage directly onto paved surfaces.
- Design lot to include semi-permeable hardscape.
- Structural BMPs such as storm drain inlet filters can be very effective in reducing the amount of pollutants discharged from parking facilities during periods of rain.

References and Resources

Bay Area Stormwater Management Agencies Association (BASMAA). 1996. Pollution From Surface Cleaning Folder <http://www.basmaa.org>

Model Urban Runoff Program: A How-To Guide for Developing Urban Runoff Programs for Small Municipalities. Prepared by City of Monterey, City of Santa Cruz, California Coastal Commission, Monterey Bay National Marine Sanctuary, Association of Monterey Bay Area Governments, Woodward-Clyde, Central Coast Regional Water Quality Control Board. July. 1998.

Oregon Association of Clean Water Agencies. Oregon Municipal Stormwater Toolbox for Maintenance Practices. June 1998.

Orange County Stormwater Program

http://www.ocwatersheds.com/stormwater/swp_introduction.asp

Santa Clara Valley Urban Runoff Pollution Prevention Program. 1997 Urban Runoff Management Plan. September 1997, updated October 2000.

Santa Clara Valley Urban Runoff Pollution Prevention Program. Maintenance Best Management Practices for the Construction Industry. Brochures: Landscaping, Gardening, and Pool; Roadwork and Paving; and Fresh Concrete and Mortar Application. June 2001.

San Diego Stormwater Co-permittees Jurisdictional Urban Runoff Management Plan. 2001. Municipal Activities Model Program Guidance. November.



Design Objectives

- Maximize Infiltration
- Provide Retention
- Slow Runoff
- Minimize Impervious Land Coverage
- Prohibit Dumping of Improper Materials
- Contain Pollutants
- Collect and Convey

Description

Waste materials dumped into storm drain inlets can have severe impacts on receiving and ground waters. Posting notices regarding discharge prohibitions at storm drain inlets can prevent waste dumping. Storm drain signs and stencils are highly visible source controls that are typically placed directly adjacent to storm drain inlets.

Approach

The stencil or affixed sign contains a brief statement that prohibits dumping of improper materials into the urban runoff conveyance system. Storm drain messages have become a popular method of alerting the public about the effects of and the prohibitions against waste disposal.

Suitable Applications

Stencils and signs alert the public to the destination of pollutants discharged to the storm drain. Signs are appropriate in residential, commercial, and industrial areas, as well as any other area where contributions or dumping to storm drains is likely.

Design Considerations

Storm drain message markers or placards are recommended at all storm drain inlets within the boundary of a development project. The marker should be placed in clear sight facing toward anyone approaching the inlet from either side. All storm drain inlet locations should be identified on the development site map.

Designing New Installations

The following methods should be considered for inclusion in the project design and show on project plans:

- Provide stenciling or labeling of all storm drain inlets and catch basins, constructed or modified, within the project area with prohibitive language. Examples include “NO DUMPING



– DRAINS TO OCEAN” and/or other graphical icons to discourage illegal dumping.

- Post signs with prohibitive language and/or graphical icons, which prohibit illegal dumping at public access points along channels and creeks within the project area.

Note - Some local agencies have approved specific signage and/or storm drain message placards for use. Consult local agency stormwater staff to determine specific requirements for placard types and methods of application.

Redeveloping Existing Installations

Various jurisdictional stormwater management and mitigation plans (SUSMP, WQMP, etc.) define “redevelopment” in terms of amounts of additional impervious area, increases in gross floor area and/or exterior construction, and land disturbing activities with structural or impervious surfaces. If the project meets the definition of “redevelopment”, then the requirements stated under “designing new installations” above should be included in all project design plans.

Additional Information

Maintenance Considerations

- Legibility of markers and signs should be maintained. If required by the agency with jurisdiction over the project, the owner/operator or homeowner’s association should enter into a maintenance agreement with the agency or record a deed restriction upon the property title to maintain the legibility of placards or signs.

Placement

- Signage on top of curbs tends to weather and fade.
- Signage on face of curbs tends to be worn by contact with vehicle tires and sweeper brooms.

Supplemental Information

Examples

- Most MS4 programs have storm drain signage programs. Some MS4 programs will provide stencils, or arrange for volunteers to stencil storm drains as part of their outreach program.

Other Resources

A Manual for the Standard Urban Stormwater Mitigation Plan (SUSMP), Los Angeles County Department of Public Works, May 2002.

Model Standard Urban Storm Water Mitigation Plan (SUSMP) for San Diego County, Port of San Diego, and Cities in San Diego County, February 14, 2002.

Model Water Quality Management Plan (WQMP) for County of Orange, Orange County Flood Control District, and the Incorporated Cities of Orange County, Draft February 2003.

Ventura Countywide Technical Guidance Manual for Stormwater Quality Control Measures, July 2002.

3.5 Bioretention Facility

Type of BMP	LID – Bioretention
Treatment Mechanisms	Infiltration, Evapotranspiration, Evaporation, Biofiltration
Maximum Drainage Area	This BMP is intended to be integrated into a project’s landscaped area in a distributed manner. Typically, contributing drainage areas to Bioretention Facilities range from less than 1 acre to a maximum of around 10 acres.
Other Names	Rain Garden, Bioretention Cell, Bioretention Basin, Biofiltration Basin, Landscaped Filter Basin, Porous Landscape Detention

Description

Bioretention Facilities are shallow, vegetated basins underlain by an engineered soil media. Healthy plant and biological activity in the root zone maintain and renew the macro-pore space in the soil and maximize plant uptake of pollutants and runoff. This keeps the Best Management Practice (BMP) from becoming clogged and allows more of the soil column to function as both a sponge (retaining water) and a highly effective and self-maintaining biofilter. In most cases, the bottom of a Bioretention Facility is unlined, which also provides an opportunity for infiltration to the extent the underlying onsite soil can accommodate. When the infiltration rate of the underlying soil is exceeded, fully biotreated flows are discharged via underdrains. Bioretention Facilities therefore will inherently achieve the maximum feasible level of infiltration and evapotranspiration and achieve the minimum feasible (but highly biotreated) discharge to the storm drain system.

Siting Considerations

These facilities work best when they are designed in a relatively level area. Unlike other BMPs, Bioretention Facilities can be used in smaller landscaped spaces on the site, such as:

- ✓ Parking islands
- ✓ Medians
- ✓ Site entrances

Landscaped areas on the site (such as may otherwise be required through minimum landscaping ordinances), can often be designed as Bioretention Facilities. This can be accomplished by:

- *Depressing* landscaped areas below adjacent impervious surfaces, rather than elevating those areas
- Grading the site to direct runoff from those impervious surfaces *into* the Bioretention Facility, rather than away from the landscaping
- Sizing and designing the depressed landscaped area as a Bioretention Facility as described in this Fact Sheet

Bioretention Facilities should however not be used downstream of areas where large amounts of sediment can clog the system. Placing a Bioretention Facility at the toe of a steep slope should also be avoided due to the potential for clogging the engineered soil media with erosion from the slope, as well as the potential for damaging the vegetation.

Design and Sizing Criteria

The recommended cross section necessary for a Bioretention Facility includes:

- Vegetated area
- 18' minimum depth of engineered soil media
- 12' minimum gravel layer depth with 6' perforated pipes (added flow control features such as orifice plates may be required to mitigate for HCOC conditions)

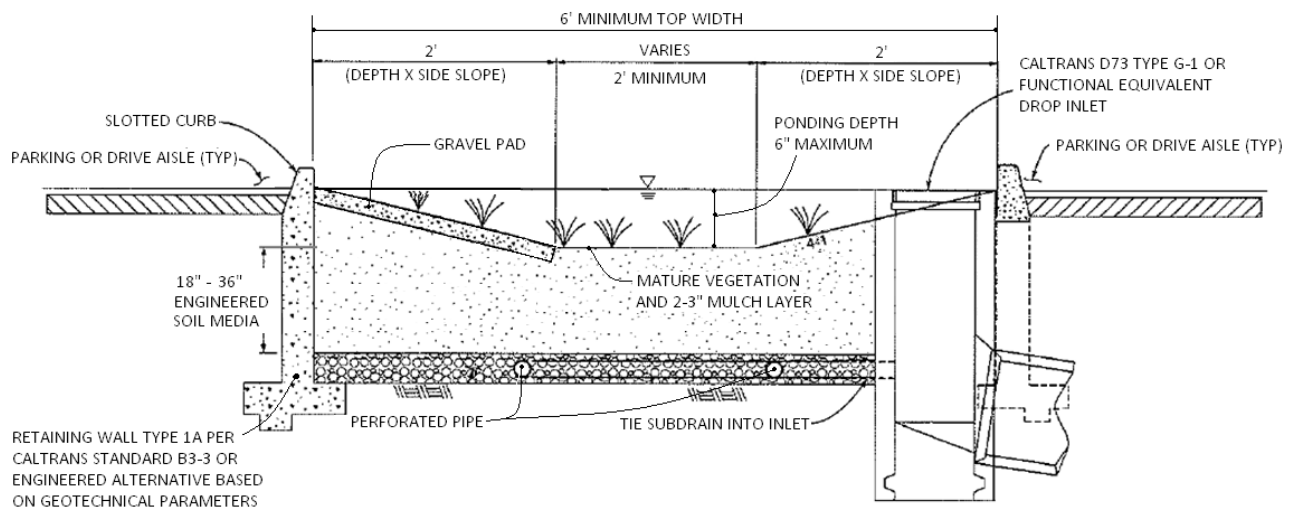

While the 18-inch minimum engineered soil media depth can be used in some cases, it is recommended to use 24 inches or a preferred 36 inches to provide an adequate root zone for the chosen plant palate. Such a design also provides for improved removal effectiveness for nutrients. The recommended ponding depth inside of a Bioretention Facility is 6 inches; measured from the flat bottom surface to the top of the water surface as shown in Figure 1.

Because this BMP is filled with an engineered soil media, pore space in the soil and gravel layer is assumed to provide storage volume. However, several considerations must be noted:

- Surcharge storage above the soil surface (6 inches) is important to assure that design flows do not bypass the BMP when runoff exceeds the soil's absorption rate.
- In cases where the Bioretention Facility contains engineered soil media deeper than 36 inches, the pore space within the engineered soil media can only be counted to the 36-inch depth.
- A maximum of 30 percent pore space can be used for the soil media whereas a maximum of 40 percent pore space can be use for the gravel layer.

Figure 1: Standard Layout for a Bioretention Facility

BIORETENTION FACILITY BMP FACT SHEET

Engineered Soil Media Requirements

The engineered soil media shall be comprised of 85 percent mineral component and 15 percent organic component, by volume, drum mixed prior to placement. The mineral component shall be a Class A sandy loam topsoil that meets the range specified in Table 1 below. The organic component shall be nitrogen stabilized compost¹, such that nitrogen does not leach from the media.

Table 1: Mineral Component Range Requirements

Percent Range	Component
70-80	Sand
15-20	Silt
5-10	Clay

The trip ticket, or certificate of compliance, shall be made available to the inspector to prove the engineered mix meets this specification.

Vegetation Requirements

Vegetative cover is important to minimize erosion and ensure that treatment occurs in the Bioretention Facility. The area should be designed for at least 70 percent mature coverage throughout the Bioretention Facility. To prevent the BMP from being used as walkways, Bioretention Facilities shall be planted with a combination of small trees, densely planted shrubs, and natural grasses. Grasses shall be native or ornamental; preferably ones that do not need to be mowed. The application of fertilizers and pesticides should be minimal. To maintain oxygen levels for the vegetation and promote biodegradation, it is important that vegetation not be completely submerged for any extended period of time. Therefore, a maximum of 6 inches of ponded water shall be used in the design to ensure that plants within the Bioretention Facility remain healthy.

A 2 to 3-inch layer of standard shredded aged hardwood mulch shall be placed as the top layer inside the Bioretention Facility. The 6-inch ponding depth shown in Figure 1 above shall be measured from the top surface of the 2 to 3-inch mulch layer.

Curb Cuts

To allow water to flow into the Bioretention Facility, 1-foot-wide (minimum) curb cuts should be placed approximately every 10 feet around the perimeter of the Bioretention Facility. Figure 2 shows a curb cut in a Bioretention Facility. Curb cut flow lines must be at or above the V_{BMP} water surface level.

¹ For more information on compost, visit the US Composting Council website at: <http://compostingcouncil.org/>

BIORETENTION FACILITY BMP FACT SHEET



Figure 2: Curb Cut located in a Bioretention Facility

To reduce erosion, a gravel pad shall be placed at each inlet point to the Bioretention Facility. The gravel should be 1- to 1.5-inch diameter in size. The gravel should overlap the curb cut opening a minimum of 6 inches. The gravel pad inside the Bioretention Facility should be flush with the finished surface at the curb cut and extend to the bottom of the slope.

In addition, place an apron of stone or concrete, a foot square or larger, inside each inlet to prevent vegetation from growing up and blocking the inlet. See Figure 3.

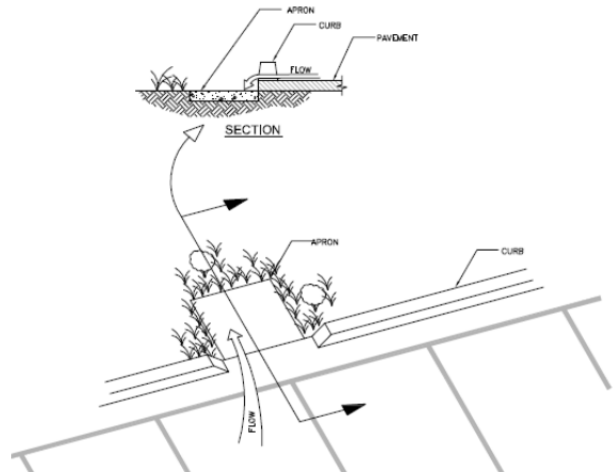

Figure 3: Apron located in a Bioretention Facility

Terracing the Landscaped Filter Basin

It is recommended that Bioretention Facilities be level. In the event the facility site slopes and lacks proper design, water would fill the lowest point of the BMP and then discharge from the basin without being treated. To ensure that the water will be held within the Bioretention Facility on sloped sites, the BMP must be terraced with nonporous check dams to provide the required storage and treatment capacity.

The terraced version of this BMP shall be used on non-flat sites with no more than a 3 percent slope. The surcharge depth cannot exceed 0.5 feet, and side slopes shall not exceed 4:1. Table 2 below shows the spacing of the check dams, and slopes shall be rounded up (i.e., 2.5 percent slope shall use 10' spacing for check dams).

Table 2: Check Dam Spacing

6" Check Dam Spacing	
Slope	Spacing
1%	25'
2%	15'
3%	10'

BIORETENTION FACILITY BMP FACT SHEET

Roof Runoff

Roof downspouts may be directed towards Bioretention Facilities. However, the downspouts must discharge onto a concrete splash block to protect the Bioretention Facility from erosion.

Retaining Walls

It is recommended that Retaining Wall Type 1A, per Caltrans Standard B3-3 or equivalent, be constructed around the entire perimeter of the Bioretention Facility. This practice will protect the sides of the Bioretention Facility from collapsing during construction and maintenance or from high service loads adjacent to the BMP. Where such service loads would not exist adjacent to the BMP, an engineered alternative may be used if signed by a licensed civil engineer.

Side Slope Requirements

Bioretention Facilities Requiring Side Slopes

The design should assure that the Bioretention Facility does not present a tripping hazard. Bioretention Facilities proposed near pedestrian areas, such as areas parallel to parking spaces or along a walkway, must have a gentle slope to the bottom of the facility. Side slopes inside of a Bioretention Facility shall be 4:1. A typical cross section for the Bioretention Facility is shown in Figure 1.

Bioretention Facilities Not Requiring Side Slopes

Where cars park perpendicular to the Bioretention Facility, side slopes are not required. A 6-inch maximum drop may be used, and the Bioretention Facility must be planted with trees and shrubs to prevent pedestrian access. In this case, a curb is not placed around the Bioretention Facility, but wheel stops shall be used to prevent vehicles from entering the Bioretention Facility, as shown in Figure 4.

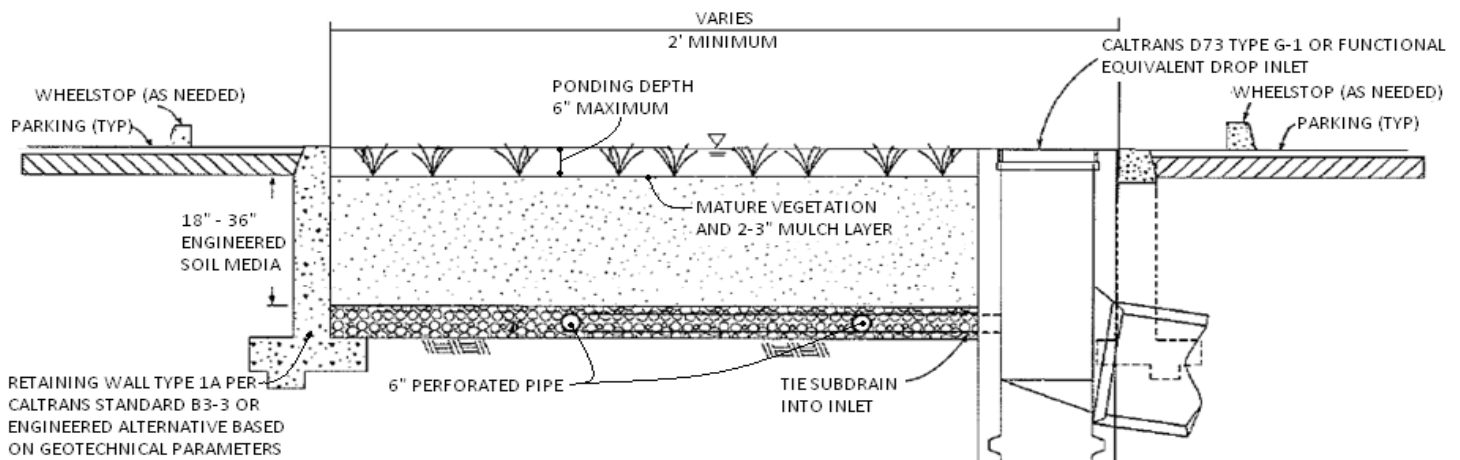

BIORETENTION FACILITY BMP FACT SHEET

Planter Boxes

Bioretention Facilities can also be placed above ground as planter boxes. Planter boxes must have a minimum width of 2 feet, a maximum surcharge depth of 6 inches, and no side slopes are necessary. Planter boxes must be constructed so as to ensure that the top surface of the engineered soil media will remain level. This option may be constructed of concrete, brick, stone or other stable materials that will not warp or bend. Chemically treated wood or galvanized steel, which has the ability to contaminate stormwater, should not be used. Planter boxes must be lined with an impermeable liner on all sides, including the bottom. Due to the impermeable liner, the inside bottom of the planter box shall be designed and constructed with a cross fall, directing treated flows within the subdrain layer toward the point where subdrain exits the planter box, and subdrains shall be oriented with drain holes oriented down. These provisions will help avoid excessive stagnant water within the gravel underdrain layer. Similar to the in-ground Bioretention Facility versions, this BMP benefits from healthy plants and biological activity in the root zone. Planter boxes should be planted with appropriately selected vegetation.



Figure 5: Planter Box

Source: LA Team Effort

Overflow

An overflow route is needed in the Bioretention Facility design to bypass stored runoff from storm events larger than V_{BMP} or in the event of facility or subdrain clogging. Overflow systems must connect to an acceptable discharge point, such as a downstream conveyance system as shown in Figure 1 and Figure 4. The inlet to the overflow structure shall be elevated inside the Bioretention Facility to be flush with the ponding surface for the design capture volume (V_{BMP}) as shown in Figure 4. This will allow the design capture volume to be fully treated by the Bioretention Facility, and for larger events to safely be conveyed to downstream systems. The overflow inlet shall **not** be located in the entrance of a Bioretention Facility, as shown in Figure 6.

BIORETENTION FACILITY BMP FACT SHEET

Underdrain Gravel and Pipes

An underdrain gravel layer and pipes shall be provided in accordance with Appendix B – Underdrains.



Figure 6: Incorrect Placement of an Overflow Inlet.

Inspection and Maintenance Schedule

The Bioretention Facility area shall be inspected for erosion, dead vegetation, soggy soils, or standing water. The use of fertilizers and pesticides on the plants inside the Bioretention Facility should be minimized.

Schedule	Activity
Ongoing	<ul style="list-style-type: none">• Keep adjacent landscape areas maintained. Remove clippings from landscape maintenance activities.• Remove trash and debris• Replace damaged grass and/or plants• Replace surface mulch layer as needed to maintain a 2-3 inch soil cover.
After storm events	<ul style="list-style-type: none">• Inspect areas for ponding
Annually	<ul style="list-style-type: none">• Inspect/clean inlets and outlets

Bioretention Facility Design Procedure

- 1) Enter the area tributary, A_T , to the Bioretention Facility.
- 2) Enter the Design Volume, V_{BMP} , determined from Section 2.1 of this Handbook.
- 3) Select the type of design used. There are two types of Bioretention Facility designs: the standard design used for most project sites that include side slopes, and the modified design used when the BMP is located perpendicular to the parking spaces or with planter boxes that do not use side slopes.
- 4) Enter the depth of the engineered soil media, d_s . The minimum depth for the engineered soil media can be 18' in limited cases, but it is recommended to use 24' or a preferred 36' to provide an adequate root zone for the chosen plant palette. Engineered soil media deeper than 36' will only get credit for the pore space in the first 36'.
- 5) Enter the top width of the Bioretention Facility.
- 6) Calculate the total effective depth, d_E , within the Bioretention Facility. The maximum allowable pore space of the soil media is 30% while the maximum allowable pore space for the gravel layer is 40%. Gravel layer deeper than 12' will only get credit for the pore space in the first 12'.

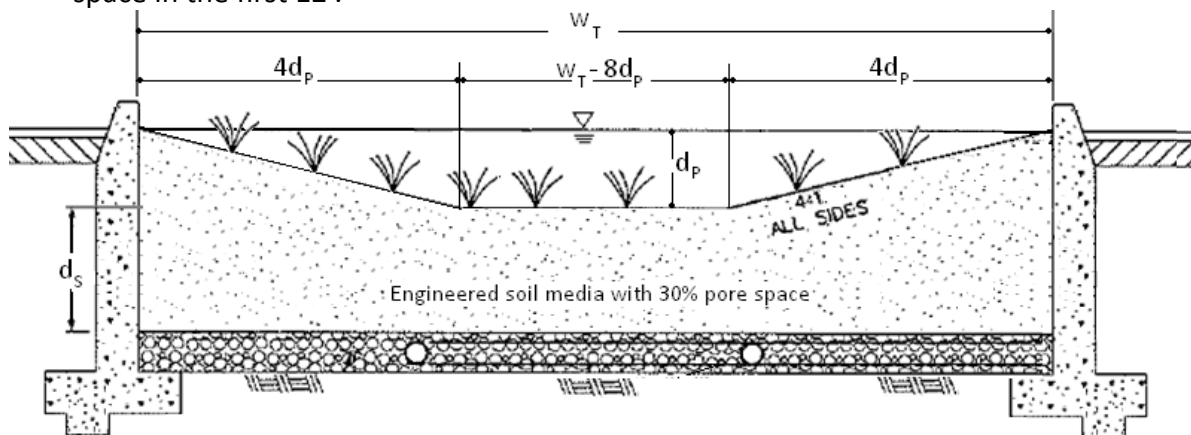

- a. For the design with side slopes the following equation shall be used to determine the total effective depth. Where, d_p is the depth of ponding within the basin.

$$d_E(\text{ft}) = \frac{0.3 \times \left[(w_T(\text{ft}) \times d_s(\text{ft})) + 4(d_p(\text{ft}))^2 \right] + 0.4 \times 1(\text{ft}) + d_p(\text{ft}) \left[4d_p(\text{ft}) + (w_T(\text{ft}) - 8d_p(\text{ft})) \right]}{w_T(\text{ft})}$$

This above equation can be simplified if the maximum ponding depth of 0.5' is used. The equation below is used on the worksheet to find the minimum area required for the Bioretention Facility:

$$d_E(\text{ft}) = (0.3 \times d_s(\text{ft}) + 0.4 \times 1(\text{ft})) - \left(\frac{0.7(\text{ft}^2)}{w_T(\text{ft})} \right) + 0.5(\text{ft})$$

- b. For the design without side slopes the following equation shall be used to determine the total effective depth:

$$d_E(\text{ft}) = d_p(\text{ft}) + [(0.3) \times d_s(\text{ft}) + (0.4) \times 1(\text{ft})]$$

The equation below, using the maximum ponding depth of 0.5', is used on the worksheet to find the minimum area required for the Bioretention Facility:

$$d_E(\text{ft}) = 0.5(\text{ft}) + [(0.3) \times d_s(\text{ft}) + (0.4) \times 1(\text{ft})]$$

- 7) Calculate the minimum surface area, A_M , required for the Bioretention Facility. This does not include the curb surrounding the Bioretention Facility or side slopes.

$$A_M(\text{ft}^2) = \frac{V_{\text{BMP}}(\text{ft}^3)}{d_E(\text{ft})}$$

- 8) Enter the proposed surface area. This area shall not be less than the minimum required surface area.
- 9) Verify that side slopes are no steeper than 4:1 in the standard design, and are not required in the modified design.
- 10) Provide the diameter, minimum 6 inches, of the perforated underdrain used in the Bioretention Facility. See Appendix B for specific information regarding perforated pipes.
- 11) Provide the slope of the site around the Bioretention Facility, if used. The maximum slope is 3 percent for a standard design.
- 12) Provide the check dam spacing, if the site around the Bioretention Facility is sloped.
- 13) Describe the vegetation used within the Bioretention Facility.

References Used to Develop this Fact Sheet

Anderson, Dale V. "Landscaped Filter Basin Soil Requirements." Riverside, May 2010.

California Department of Transportation. CalTrans Standard Plans. 15 September 2005. May 2010 <http://www.dot.ca.gov/hq/esc/oe/project_plans/HTM/stdplns-met-new99.htm>.

Camp Dresser and McKee Inc.; Larry Walker Associates. California Stormwater Best Management Practice Handbook for New Development and Redevelopment. California Stormwater Quality Association (CASQA), 2004.

Contra Costa Clean Water Program. Stormwater Quality Requirements for Development Applications. 3rd Edition. Contra Costa, 2006.

County of Los Angeles Public Works. Stormwater Best Management Practice Design and Maintenance Manual. Los Angeles, 2009.

Kim, Hunho, Eric A. Seagren and Allen P. Davis. "Engineered Bioretention for Removal of Nitrate from Stormwater Runoff." Water Environment Research 75.4 (2003): 355-366.

LA Team Effort. LA Team Effort: FREE Planter Boxes for Businesses. 2 November 2009. May 2010 <<http://lateameffort.blogspot.com/2009/11/free-planter-boxes-for-businesses-est.html>>.

Montgomery County Maryland Department of Permitting Services Water Resources Section. Biofiltration (BF). Montgomery County, 2005.

Program, Ventura Countywide Stormwater Quality Management. Technical Guidance Manual for Stormwater Quality Control Measures. Ventura, 2002.

United States Environmental Protection Agency. Storm Water Technology Fact Sheet Bioretention. Washington D.C, 1999.

Urban Drainage and Flood Control District. Urban Storm Drainage Criteria Manual Volume 3 - Best Management Practices. Vol. 3. Denver, 2008. 3 vols.

Urbonas, Ben R. Stormwater Sand Filter Sizing and Design: A Unit Operations Approach. Denver: Urban Drainage and Flood Control District, 2002.



MC-3500 & MC-4500 Design Manual

StormTech® Chamber Systems for Stormwater Management



THE MOST **ADVANCED** NAME IN WATER MANAGEMENT SOLUTIONS™

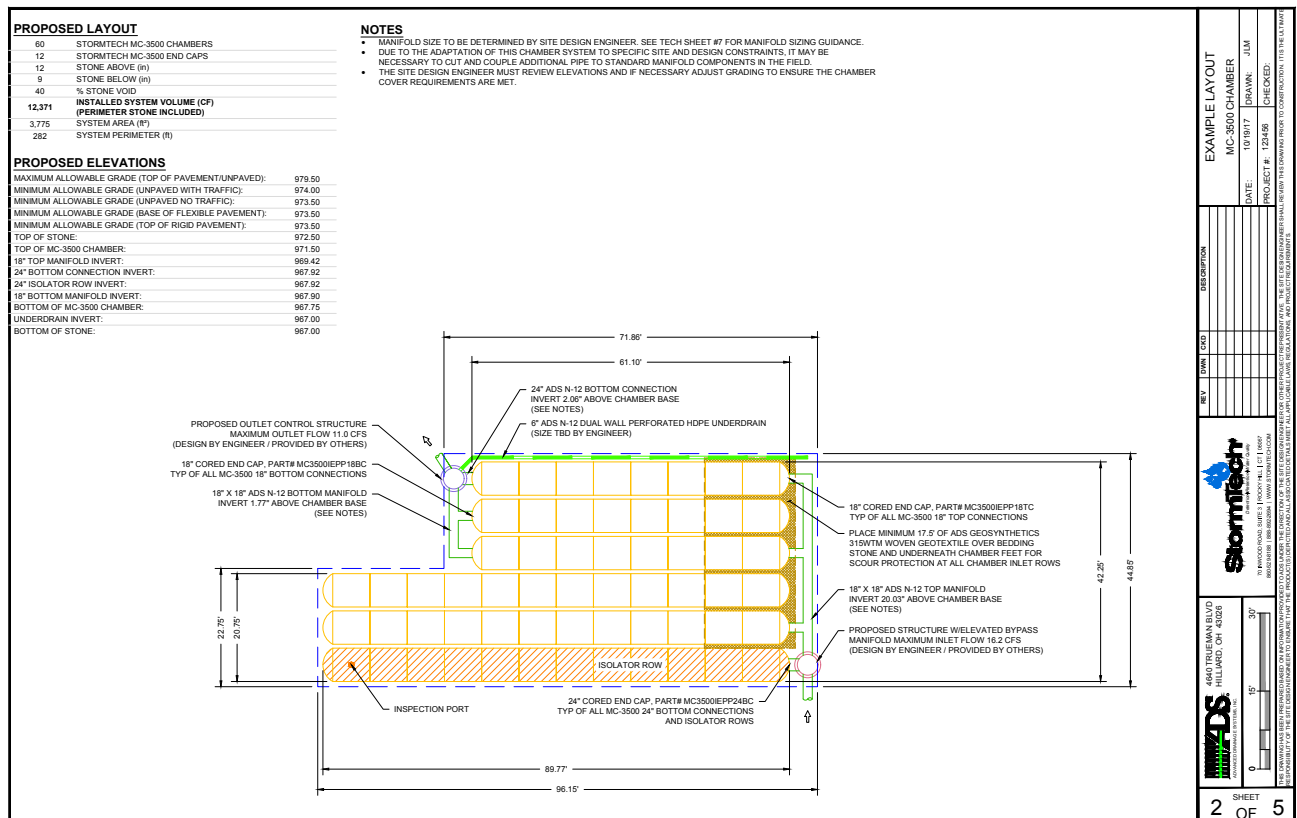

Table of Contents

1.0	Product Information	2
2.0	Foundation for Chambers.	8
3.0	Required Materials/Row Separation	11
4.0	Hydraulics.	13
5.0	Cumulative Storage Volume	15
6.0	System Sizing.	20
7.0	Structural Cross Sections and Specifications	22
8.0	General Notes.	24
9.0	Inspection and Maintenance	25

*For SC-310, SC-740 & DC-780 designs, please refer to the SC-310/SC-740/DC-780 Design Manual.

StormTech Engineering Services assists design professionals in specifying StormTech stormwater systems. This assistance includes the layout of chambers to meet the engineer's volume requirements and the connections to and from the chambers. They can also assist converting and cost engineering projects currently specified with ponds, pipe, concrete vaults and other manufactured stormwater detention/retention products. Please note that it is the responsibility of the site design engineer to ensure that the chamber bed layout meets all design requirements and is in compliance with applicable laws and regulations governing a project.



This manual is exclusively intended to assist engineers in the design of subsurface stormwater systems using StormTech chambers.

Call StormTech at **860.529.8188** or **888.892.2694** or visit our website at www.stormtech.com for technical and product information.

StormTech MC-3500 Chamber

MC-3500 Chamber

Designed to meet the most stringent industry performance standards for superior structural integrity while providing designers with a cost-effective method to save valuable land and protect water resources. The StormTech system is designed primarily to be used under parking lots, thus maximizing land usage for commercial and municipal applications.

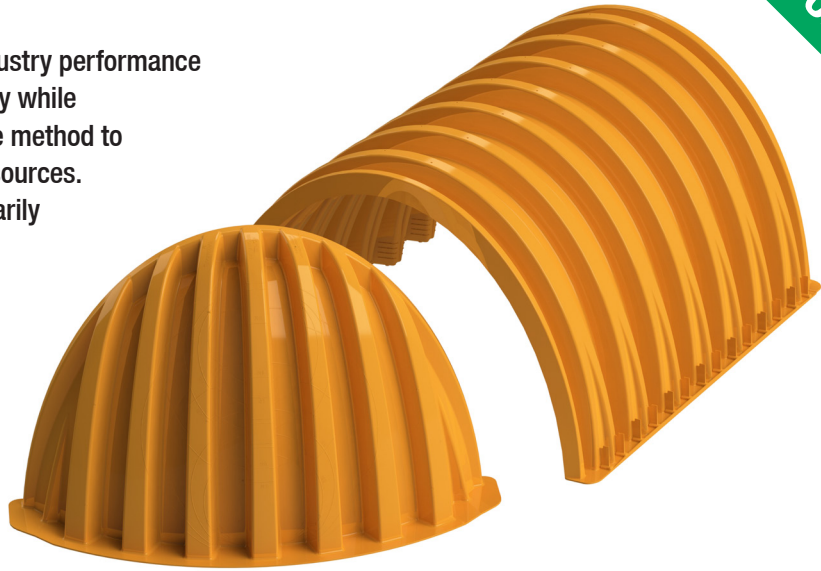

StormTech MC-3500 Chamber (not to scale)

Nominal Chamber Specifications

Size (L x W x H)	90" (2286 mm) x 77" (1956 mm) x 45" (1143 mm)
Chamber Storage	109.9 ft ³ (3.11 m ³)
Min. Installed Storage*	178.9 ft ³ (5.06 m ³)
Weight	134 lbs (60.8 kg)

*This assumes a minimum of 12" (300 mm) of stone above, 9" (230 mm) of stone between chambers/end caps and 40% stone porosity.

StormTech MC-3500 End Cap (not to scale)

Nominal Chamber Specifications

Size (L x W x H)	26.5" (673 mm) x 71" (1803 mm) x 45.1" (1145 mm)
Chamber Storage	14.9 ft ³ (0.42 m ³)
Min. Installed Storage*	46.0 ft ³ (1.30 m ³)
Weight	49 lbs (22.2 kg)

*This assumes a minimum of 12" (300 mm) of stone above, 9" (230 mm) of stone below, 6" (150 mm) of stone perimeter, 9" (230 mm) between chambers/end caps and 40% stone porosity.

Shipping

15 chambers/pallet

16 end caps/pallet

7 pallets/truck

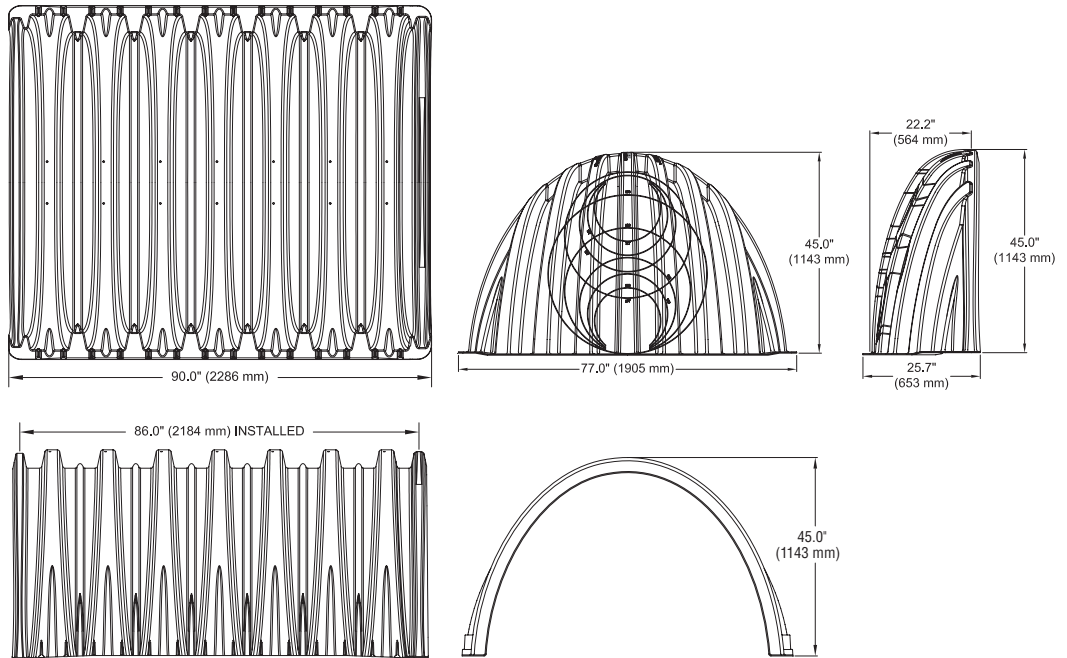

StormTech MC-3500 Chamber

Storage Volume Per Chamber/End Cap ft³ (m³)

	Bare Unit Storage ft ³ (m ³)	Chamber/End Cap and Stone Volume — Stone Foundation Depth in. (mm)			
		9	12	15	18
		(230)	(300)	(375)	(450)
MC-3500 Chamber	109.9 (3.11)	178.9 (5.06)	184.0 (5.21)	189.2 (5.36)	194.3 (5.5)
MC-3500 End Cap	14.9 (0.42)	46.0 (1.33)	47.7 (1.35)	49.4 (1.40)	51.1 (1.45)

NOTE: Assumes 9" (230 mm) row spacing, 40% stone porosity, 12" (300 mm) stone above and includes the bare chamber/end cap volume. End cap volume assumes 6" (150 mm) stone perimeter.

Amount of Stone Per Chamber

ENGLISH tons (yd ³)	Stone Foundation Depth			
	9"	12"	15"	18"
MC-3500	9.1 (6.4)	9.7 (6.9)	10.4 (7.3)	11.1 (7.8)
End Cap	4.1 (2.9)	4.3 (3.0)	4.5 (3.2)	4.7 (3.3)
METRIC kg (m ³)	230 mm	300 mm	375 mm	450 mm
MC-3500	8220 (4.9)	8831 (5.3)	9443 (5.6)	10054 (6.0)
End Cap	3699 (2.2)	3900(2.3)	4100 (2.5)	4301 (2.6)

NOTE: Assumes 12" (300 mm) of stone above, and 9" (230 mm) row spacing, and 6" (150 mm) of perimeter stone in front of end caps.

Volume of Excavation Per Chamber/End Cap yd³ (m³)

	Stone Foundation Depth			
	9" (230 mm)	12" (300 mm)	15"(375 mm)	18"(450 mm)
MC-3500	12.4 (9.5)	12.8 (9.8)	13.3 (10.2)	13.8 (10.5)
End Cap	4.1 (3.1)	4.2 (3.2)	4.4 (3.3)	4.5 (3.5)

NOTE: Assumes 9" (230 mm) separation between chamber rows and 24" (600 mm) of cover. The volume of excavation will vary as the depth of cover increases.



General Cross Section

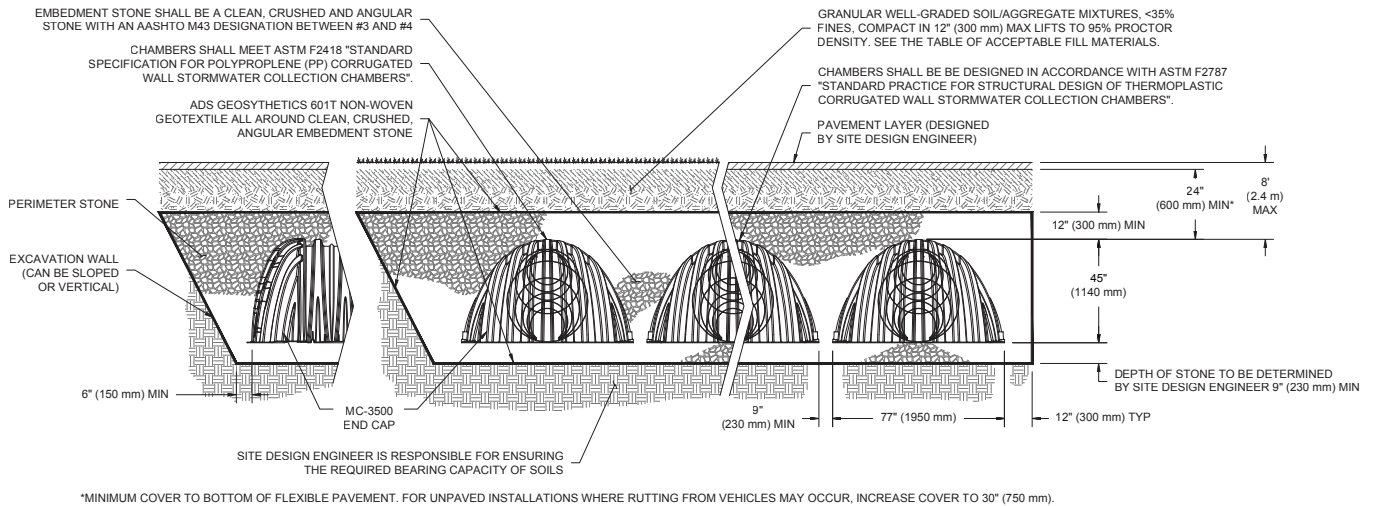

Special applications will be considered on a project by project basis. Please contact our application department should you have a unique application for our team to evaluate.

StormTech MC-4500 Chamber

MC-4500 Chamber

Designed to meet the most stringent industry performance standards for superior structural integrity while providing designers with a cost-effective method to save valuable land and protect water resources. The StormTech system is designed primarily to be used under parking lots, thus maximizing land usage for commercial and municipal applications.

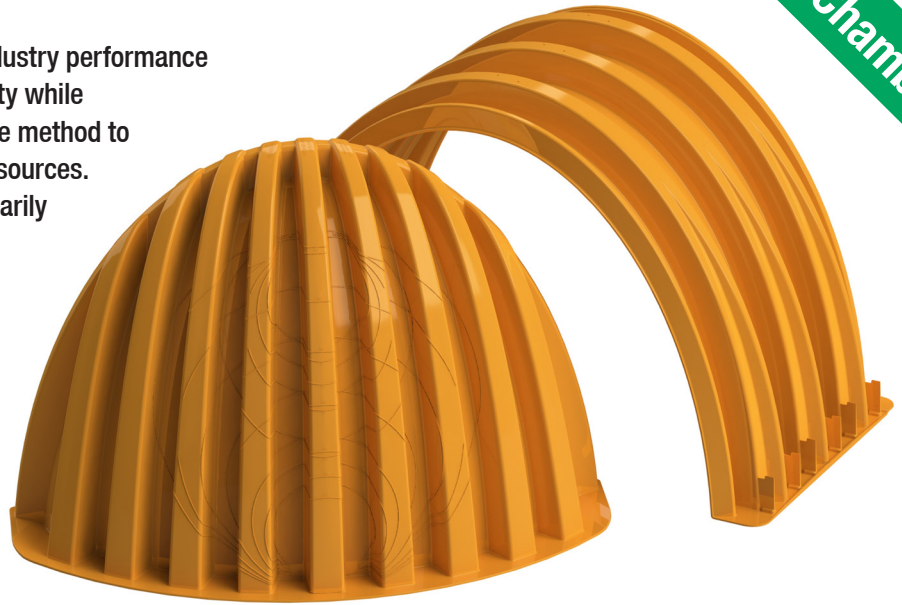

StormTech MC-3500 Chamber (not to scale)

Nominal Chamber Specifications

Size (L x W x H)	52" (1321 mm) x 100" (2540 mm) x 60" (1524 mm)
Chamber Storage	106.5 ft ³ (3.01 m ³)
Min. Installed Storage*	162.6 ft ³ (4.60 m ³)
Weight	120 lbs (54.4 kg)

*This assumes a minimum of 12" (300 mm) of stone above, 9" (230 mm) of stone below chambers, 9" (230 mm) between chambers/end caps and 40% stone porosity.

StormTech MC-3500 End Cap (not to scale)

Nominal Chamber Specifications

Size (L x W x H)	35.1" (891 mm) x 90.2" (2291 mm) x 59.4" (1509 mm)
Chamber Storage	35.7 ft ³ (1.01 m ³)
Min. Installed Storage*	108.7 ft ³ (3.08 m ³)
Weight	120 lbs (54.4 kg)

*This assumes a minimum of 12" (300 mm) of stone above, 9" (230 mm) of stone below, 6" (150 mm) of stone perimeter, 9" (230 mm) between chambers/end caps and 40% stone porosity.

Shipping

7 chambers/pallet

11 pallets/truck

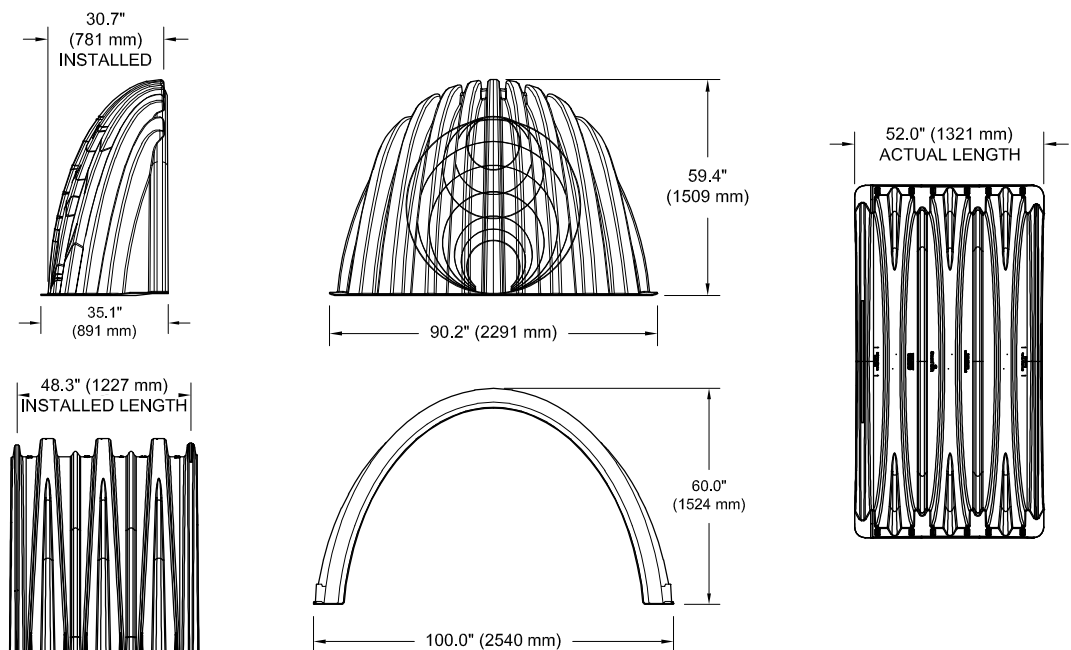

StormTech MC-4500 Chamber

Storage Volume Per Chamber/End Cap ft³ (m³)

	Bare Unit Storage ft ³ (m ³)	Chamber/End Cap and Stone Volume — Stone Foundation Depth in. (mm)			
		9	12	15	18
		(230)	(300)	(375)	(450)
MC-4500 Chamber	106.5 (3.02)	162.6 (4.60)	166.3 (4.71)	169.9 (4.81)	173.6 (4.91)
MC-4500 End Cap	35.7 (1.01)	108.7 (3.08)	111.9 (3.17)	115.2 (3.26)	118.4 (3.35)

NOTE: Assumes 9" (230 mm) row spacing, 40% stone porosity, 12" (300 mm) stone above and includes the bare chamber/end cap volume. End cap volume assumes 12" (300 mm) stone perimeter.

Amount of Stone Per Chamber

ENGLISH tons (yd ³)	Stone Foundation Depth			
	9"	12"	15"	18"
MC-4500	7.4 (5.2)	7.8 (5.5)	8.3 (5.9)	8.8 (6.2)
End Cap	9.6 (6.8)	10.0 (7.1)	10.4 (7.4)	10.9 (7.7)
METRIC kg (m ³)	230 mm	300 mm	375 mm	450 mm
MC-4500	6681 (4.0)	7117 (4.2)	7552 (4.5)	7987 (4.7)
End Cap	8691 (5.2)	9075 (5.4)	9460 (5.6)	9845 (5.9)

NOTE: Assumes 12" (300 mm) of stone above, and 9" (230 mm) row spacing, and 12" (300 mm) of perimeter stone in front of end caps.

Volume of Excavation Per Chamber/End Cap yd³ (m³)

	Stone Foundation Depth			
	9" (230 mm)	12" (300 mm)	15" (375 mm)	18" (450 mm)
MC-4500	10.5 (8.0)	10.8 (8.3)	11.2 (8.5)	11.5 (8.8)
End Cap	9.3 (7.1)	9.6 (7.3)	9.9 (7.6)	10.2 (7.8)

NOTE: Assumes 9" (230 mm) separation between chamber rows, 12" (300 mm) of perimeter in front of end caps, and 24" (600 mm) of cover. The volume of excavation will vary as the depth of cover increases.



General Cross Section

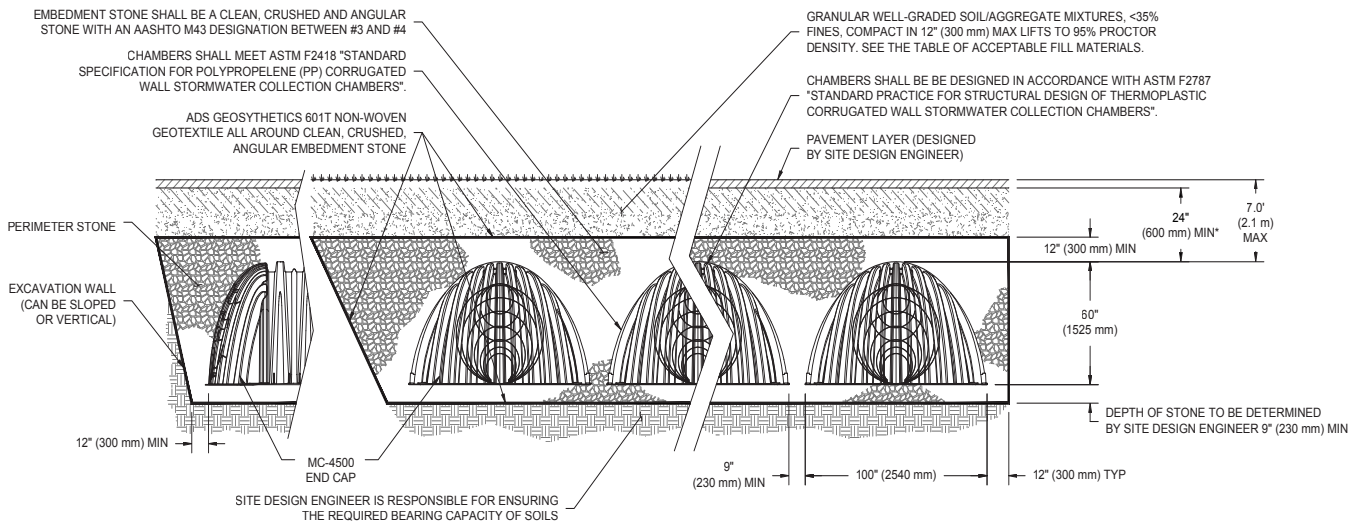

*MINIMUM COVER TO BOTTOM OF FLEXIBLE PAVEMENT. FOR UNPAVED INSTALLATIONS WHERE RUTTING FROM VEHICLES MAY OCCUR, INCREASE COVER TO 30" (750 mm).

Special applications will be considered on a project by project basis. Please contact our application department should you have a unique application for our team to evaluate.

1.1 PRODUCT DESIGN

StormTech's commitment to thorough product testing programs, materials evaluation and adherence to national standards has resulted in two more superior products. Like other StormTech chambers, the MC-3500 and MC-4500 are designed to meet the full scope of design requirements of the American Society of Testing Materials (ASTM) International specification F2787 "Standard Practice for Structural Design of Thermoplastic Corrugated Wall Stormwater Collection Chambers" and produced to the requirements of the ASTM F 2418 "Standard Specification for Polypropylene (PP) Corrugated Stormwater Collection Chambers".

The StormTech MC-3500 and MC-4500 chambers provide the full AASHTO safety factors for live loads and permanent earth loads. The ASTM F 2787 standard provides specific guidance on how to design thermoplastic chambers in accordance with AASHTO Section 12.12. of the AASHTO LRFD Bridge Design Specifications. ASTM F 2787 requires that the safety factors included in the AASHTO guidance are achieved as a prerequisite to meeting ASTM F 2418. The three standards provide both the assurance of product quality and safe structural design.

The design of larger chambers in the same tradition of our other chambers required the collaboration of experts in soil-structure interaction, plastics and manufacturing. Years of extensive research, including laboratory testing and field verification, were required to produce chambers that are ready to meet both the rigors of installation and the longevity expected by engineers and owners.

This Design Manual provides the details and specifications necessary for consulting engineers to design stormwater management systems using the MC-3500 and MC-4500 chambers. It provides specifications for storage capacities, layout dimensions as well as requirements for design to ensure a long service life. The basic design concepts for foundation and backfill materials, subgrade bearing capacities and row spacing remain equally as pertinent for the MC-3500 and MC-4500 as the SC-740, SC-310 and DC-780 chamber systems. However, since many design values and dimensional requirements are different for these larger chambers than the SC-740, SC-310 and DC-780 chambers, design manuals and installation instructions are not interchangeable.

This manual includes only those details, dimensions, cover limits, etc for the MC-3500 and MC-4500 and is intended to be a stand-alone design guide for the MC-3500 and MC-4500 chambers. A Construction Guide specifically for these two chamber models has also been published.

1.2 TECHNICAL SUPPORT

The StormTech Technical Services Department is available to assist the engineer with the layout of MC-3500 and MC-4500 chamber systems and answer questions regarding all the StormTech chamber models. Call the Technical Services Department, email us at info@stormtech.com or contact your local StormTech representative.

1.3 MC-3500 AND MC-4500 CHAMBERS

All StormTech chambers are designed to the full scope of AASHTO requirements without repeating end walls or other structural reinforcing. StormTech's continuously curved, elliptical arch and the surrounding angular backfill are the key components of the structural system. With the addition of patent pending integral stiffening ribs (**Figure 5**), the MC-3500 and MC-4500 are assured to provide a long, safe service life. Like other StormTech chambers, the MC-3500 and MC-4500 are produced from high quality, impact modified resins which are tested for short-term and long-term mechanical properties.

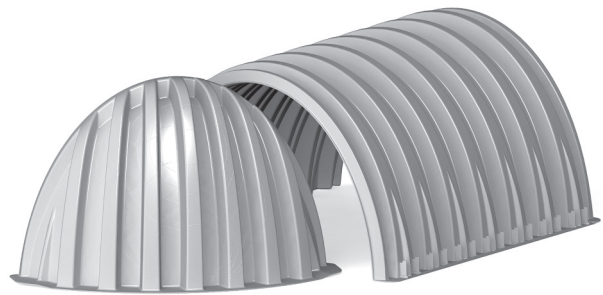

With all StormTech chambers, one chamber type is used for the start, middle and end of rows. Rows are formed by overlapping the upper joint corrugation of the next chamber over the lower joint corrugation of the previous chamber (**Figure 6**).

1.4 CHAMBER JOINTS

All StormTech chambers are designed with an optimized joining system. The height and width of the end corrugations have been designed to provide the required structural safety factors while providing an unobstructed flow path down each row.

To assist the contractor, StormTech chambers are molded with simple assembly instructions and arrows that indicate the direction in which to build rows. The corrugation valley immediately adjacent to the lower joint corrugation is marked “Overlap Here - Lower Joint.” The corrugation valley immediately adjacent to the upper joint corrugation is marked “Build This Direction - Upper Joint.”

Two people can safely and efficiently carry and place chambers without cumbersome connectors, special tools or heavy equipment. Each row of chambers must begin and end with a joint corrugation. Since joint corrugations are of a different size than the corrugations along the body of the chamber, chambers cannot be field cut and installed. Only whole MC-3500 and MC-4500 chambers can be used. For system layout assistance contact

StormTech.

1.5 MC-3500 AND MC-4500 END CAPS

The MC-3500 and MC-4500 end caps are easy to install. These end caps are designed with a corrugation joint that fits over the top of either end of the chamber. The end cap joint is simply set over the top of either of the upper or lower chamber joint corrugations (**Figure 7**).

The MC-3500 end cap has pipe cutting guides for 12”–24” (300 mm–600 mm) top inverts (**Figure 9**).

The MC-4500 end cap has pipe cutting guides for 12”–42” (300 mm–1050 mm) bottom inverts and 12”–24” (300 mm–600 mm) top inverts (**Figure 8**).

Standard and custom pre-cored end caps are available. Pre-cored end caps, 18” in diameter and larger include a welded crown plate.

FIGURE 5—Chamber and End Cap Components

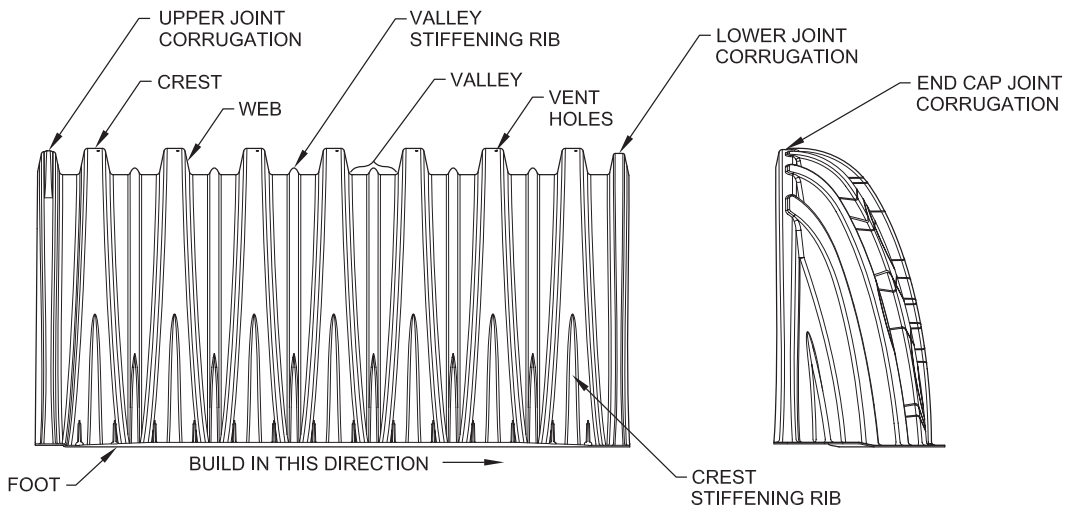

FIGURE 6—Chamber Joint Overlap

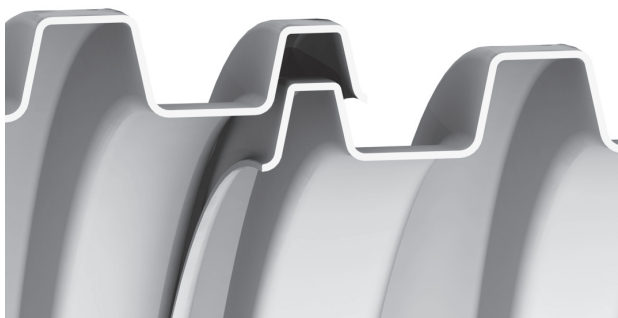

FIGURE 6—End Cap Joint Overlap

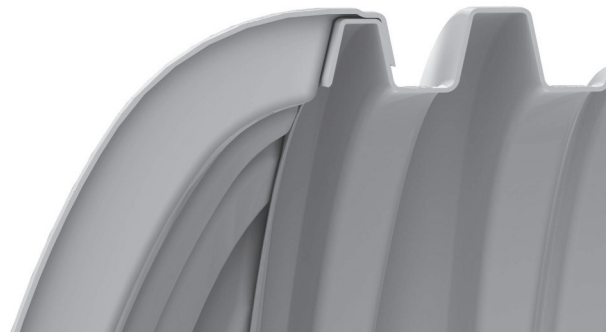

FIGURE 8—MC-4500 End Cap Inverts

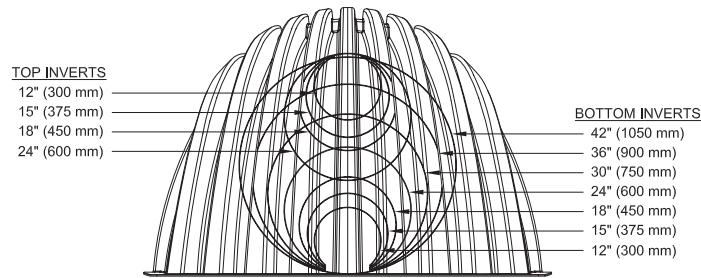
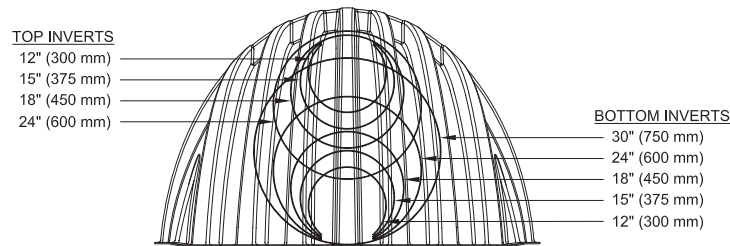

FIGURE 9—MC-4500 End Cap Inverts



2.0 Foundations for Chambers

2.1 FOUNDATION REQUIREMENTS

StormTech chamber systems can be installed in various soil types. The subgrade bearing capacity and the cover height over the chambers determine the required depth of clean, crushed, angular foundation stone below the chambers. Foundation stone, also called bedding,

is the stone between the subgrade soils and the feet of the chamber. Flexible structures are designed to transfer a significant portion of both live and dead loads through the surrounding soils. Chamber systems accomplish this by creating load paths through the columns of embedment stone between and around the rows of chambers. This creates load concentrations at the base of the columns between the rows. The foundation stone spreads out the concentrated loads to distributed loads that can be supported by the subgrade soils.

Since increasing the cover height (top of chamber to finished grade) causes increasing soil load, a greater depth of foundation stone is necessary to distribute the load to the subgrade soils. **Table 1** and **2** specify the minimum required foundation depths for varying cover heights and allowable subgrade bearing capacities. These tables are based on StormTech service loads. The minimum required foundation depth is 9" (230 mm) for both chambers.

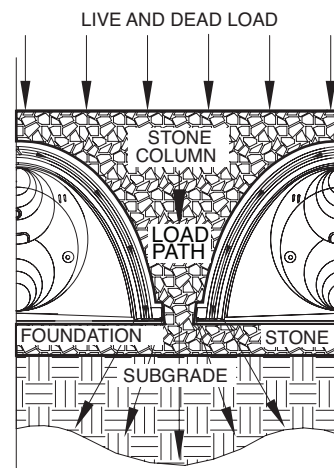

2.2 WEAKER SOILS

StormTech has not provided guidance for subgrade bearing capacities less than 2000 pounds per square foot [(2.0 ksf) (96 kPa)]. These soils are often highly variable, may contain organic materials and could be more sensitive to moisture. A geotechnical engineer must be consulted if soils with bearing capacities less than 2000 psf (96 kPa) are present.

2.0 Foundations for Chambers

TABLE 1—MC-3500 Minimum Required Foundation Depth in inches (millimeters)
Assumes 9" (230 mm) row spacing.

Cover Hgt. ft. (m)	Minimum Bearing Resistance for Service Loads ksf (kPa)																								
	4.4 (211)	4.3 (206)	4.2 (201)	4.1 (196)	4.0 (192)	3.9 (187)	3.8 (182)	3.7 (177)	3.6 (172)	3.5 (168)	3.4 (163)	3.3 (158)	3.2 (153)	3.1 (148)	3.0 (144)	2.9 (139)	2.8 (134)	2.7 (129)	2.6 (124)	2.5 (120)	2.4 (115)	2.3 (110)	2.2 (105)	2.1 (101)	2.0 (96)
2.0 (0.61)	9 (230)	9 (230)	9 (230)	9 (230)	9 (230)	9 (230)	9 (230)	9 (230)	9 (230)	9 (230)	9 (230)	9 (230)	9 (230)	9 (230)	9 (230)	9 (230)	9 (230)	9 (230)	9 (230)	12 (300)	12 (300)	12 (300)	15 (375)	15 (375)	15 (375)
2.5 (0.76)	9 (230)	9 (230)	9 (230)	9 (230)	9 (230)	9 (230)	9 (230)	9 (230)	9 (230)	9 (230)	9 (230)	9 (230)	9 (230)	9 (230)	9 (230)	9 (230)	9 (230)	12 (300)	12 (300)	12 (300)	12 (300)	15 (375)	15 (375)	15 (375)	18 (450)
3.0 (0.91)	9 (230)	9 (230)	9 (230)	9 (230)	9 (230)	9 (230)	9 (230)	9 (230)	9 (230)	9 (230)	9 (230)	9 (230)	9 (230)	9 (230)	9 (230)	9 (230)	12 (300)	12 (300)	12 (300)	15 (375)	15 (375)	15 (375)	18 (450)	18 (450)	18 (450)
3.5 (1.07)	9 (230)	9 (230)	9 (230)	9 (230)	9 (230)	9 (230)	9 (230)	9 (230)	9 (230)	9 (230)	9 (230)	9 (230)	12 (300)	12 (300)	12 (300)	12 (300)	15 (375)	15 (375)	15 (375)	15 (375)	18 (450)	18 (450)	18 (450)	24 (600)	24 (600)
4.0 (1.22)	9 (230)	9 (230)	9 (230)	9 (230)	9 (230)	9 (230)	9 (230)	9 (230)	9 (230)	9 (230)	9 (230)	12 (300)	12 (300)	12 (300)	12 (300)	15 (375)	15 (375)	15 (375)	15 (375)	18 (450)	18 (450)	18 (450)	24 (600)	24 (600)	24 (600)
4.5 (1.37)	9 (230)	9 (230)	9 (230)	9 (230)	9 (230)	9 (230)	9 (230)	9 (230)	9 (230)	9 (230)	12 (300)	12 (300)	12 (300)	12 (300)	15 (375)	15 (375)	15 (375)	15 (375)	18 (450)	18 (450)	18 (450)	24 (600)	24 (600)	24 (600)	30 (750)
5.0 (1.52)	9 (230)	9 (230)	9 (230)	9 (230)	9 (230)	9 (230)	9 (230)	9 (230)	12 (300)	12 (300)	12 (300)	12 (300)	15 (375)	15 (375)	15 (375)	15 (375)	18 (450)	18 (450)	18 (450)	24 (600)	24 (600)	24 (600)	24 (600)	24 (600)	30 (750)
5.5 (1.68)	9 (230)	9 (230)	9 (230)	9 (230)	9 (230)	9 (230)	12 (300)	12 (300)	12 (300)	12 (300)	12 (300)	15 (375)	15 (375)	15 (375)	15 (375)	18 (450)	18 (450)	18 (450)	24 (600)	24 (600)	24 (600)	24 (600)	24 (600)	30 (750)	30 (750)
6.0 (1.83)	9 (230)	9 (230)	9 (230)	9 (230)	9 (230)	12 (300)	12 (300)	12 (300)	12 (300)	12 (300)	15 (375)	15 (375)	15 (375)	15 (375)	18 (450)	18 (450)	18 (450)	24 (600)	24 (600)	24 (600)	24 (600)	24 (600)	30 (750)	30 (750)	30 (750)
6.5 (1.98)	9 (230)	9 (230)	9 (230)	9 (230)	12 (300)	12 (300)	12 (300)	12 (300)	12 (300)	15 (375)	15 (375)	15 (375)	15 (375)	18 (450)	18 (450)	18 (450)	24 (600)	24 (600)	24 (600)	24 (600)	24 (600)	30 (750)	30 (750)	30 (750)	30 (750)
7.0 (2.13)	9 (230)	9 (230)	9 (230)	12 (300)	12 (300)	12 (300)	12 (300)	12 (300)	15 (375)	15 (375)	15 (375)	15 (375)	18 (450)	18 (450)	18 (450)	24 (600)	24 (600)	24 (600)	24 (600)	24 (600)	30 (750)	30 (750)	30 (750)	30 (750)	36 (900)
7.5 (2.30)	9 (230)	9 (230)	12 (300)	12 (300)	12 (300)	12 (300)	15 (375)	15 (375)	15 (375)	15 (375)	15 (375)	18 (450)	18 (450)	18 (450)	24 (600)	24 (600)	24 (600)	24 (600)	24 (600)	24 (600)	30 (750)	30 (750)	30 (750)	36 (900)	36 (900)
8.0 (2.44)	9 (230)	12 (300)	12 (300)	12 (300)	12 (300)	15 (375)	15 (375)	15 (375)	15 (375)	18 (450)	18 (450)	18 (450)	18 (450)	24 (600)	24 (600)	24 (600)	24 (600)	24 (600)	30 (750)	30 (750)	30 (750)	36 (900)	36 (900)	36 (900)	36 (900)

NOTE: The design engineer is solely responsible for assessing the bearing resistance (allowable bearing capacity) of the subgrade soils and determining the depth of foundation stone. Subgrade bearing resistance should be assessed with consideration for the range of soil moisture conditions expected under a stormwater system.

FIGURE 10A—MC-3500 Structural Cross Section Detail (Not to Scale)

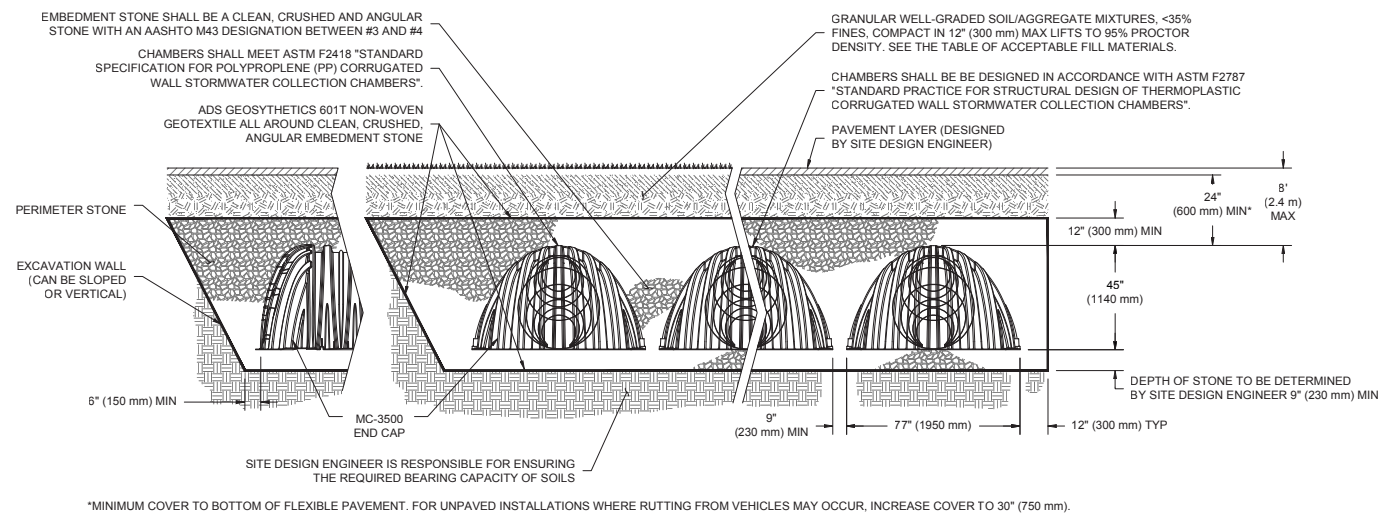

Special applications will be considered on a project by project basis. Please contact our application department should you have a unique application for our team to evaluate.

2.0 Foundations for Chambers

TABLE 2—MC-4500 Minimum Required Foundation Depth in inches (millimeters)
Assumes 9" (230 mm) row spacing.

Cover Hgt. ft. (m)	Minimum Bearing Resistance for Service Loads ksf (kPa)																								
	4.4 (211)	4.3 (206)	4.2 (201)	4.1 (196)	4.0 (192)	3.9 (187)	3.8 (182)	3.7 (177)	3.6 (172)	3.5 (168)	3.4 (163)	3.3 (158)	3.2 (153)	3.1 (148)	3.0 (144)	2.9 (139)	2.8 (134)	2.7 (129)	2.6 (124)	2.5 (120)	2.4 (115)	2.3 (110)	2.2 (105)	2.1 (101)	2.0 (96)
2.0 (0.61)	9 (230)	9 (230)	9 (230)	9 (230)	9 (230)	9 (230)	9 (230)	9 (230)	9 (230)	9 (230)	9 (230)	9 (230)	9 (230)	9 (230)	9 (230)	9 (230)	9 (230)	9 (230)	12 (300)	12 (300)	12 (300)	15 (375)	15 (375)	15 (375)	18 (450)
2.5 (0.76)	9 (230)	9 (230)	9 (230)	9 (230)	9 (230)	9 (230)	9 (230)	9 (230)	9 (230)	9 (230)	9 (230)	9 (230)	9 (230)	9 (230)	9 (230)	9 (230)	9 (230)	12 (300)	12 (300)	12 (300)	15 (375)	15 (375)	18 (450)	18 (450)	24 (600)
3.0 (0.91)	9 (230)	9 (230)	9 (230)	9 (230)	9 (230)	9 (230)	9 (230)	9 (230)	9 (230)	9 (230)	9 (230)	9 (230)	9 (230)	9 (230)	12 (300)	12 (300)	12 (300)	15 (375)	15 (375)	15 (375)	18 (450)	18 (450)	18 (450)	24 (600)	24 (600)
3.5 (1.07)	9 (230)	9 (230)	9 (230)	9 (230)	9 (230)	9 (230)	9 (230)	9 (230)	9 (230)	9 (230)	9 (230)	9 (230)	12 (300)	12 (300)	12 (300)	15 (375)	15 (375)	15 (375)	18 (450)	18 (450)	18 (450)	24 (600)	24 (600)	24 (600)	24 (600)
4.0 (1.22)	9 (230)	9 (230)	9 (230)	9 (230)	9 (230)	9 (230)	9 (230)	9 (230)	9 (230)	9 (230)	12 (300)	12 (300)	12 (300)	15 (375)	15 (375)	15 (375)	18 (450)	18 (450)	18 (450)	24 (600)	24 (600)	24 (600)	24 (600)	24 (600)	30 (750)
4.5 (1.37)	9 (230)	9 (230)	9 (230)	9 (230)	9 (230)	9 (230)	9 (230)	9 (230)	12 (300)	12 (300)	12 (300)	12 (300)	15 (375)	15 (375)	15 (375)	18 (450)	18 (450)	24 (600)	24 (600)	24 (600)	24 (600)	24 (600)	30 (750)	30 (750)	30 (750)
5.0 (1.52)	9 (230)	9 (230)	9 (230)	9 (230)	9 (230)	9 (230)	12 (300)	12 (300)	12 (300)	12 (300)	15 (375)	15 (375)	15 (375)	18 (450)	18 (450)	18 (450)	24 (600)	24 (600)	24 (600)	24 (600)	24 (600)	30 (750)	30 (750)	30 (750)	36 (900)
5.5 (1.68)	9 (230)	9 (230)	9 (230)	9 (230)	9 (230)	12 (300)	12 (300)	12 (300)	12 (300)	15 (375)	15 (375)	15 (375)	18 (450)	18 (450)	18 (450)	24 (600)	24 (600)	24 (600)	24 (600)	24 (600)	30 (750)	30 (750)	30 (750)	36 (900)	36 (900)
6.0 (1.83)	9 (230)	9 (230)	9 (230)	12 (300)	12 (300)	12 (300)	12 (300)	15 (375)	15 (375)	15 (375)	15 (375)	18 (450)	18 (450)	18 (450)	24 (600)	24 (600)	24 (600)	24 (600)	30 (750)	30 (750)	30 (750)	30 (750)	36 (900)	36 (900)	36 (900)
6.5 (1.98)	9 (230)	12 (300)	12 (300)	12 (300)	12 (300)	15 (375)	15 (375)	15 (375)	15 (375)	18 (450)	18 (450)	18 (450)	24 (600)	24 (600)	24 (600)	24 (600)	24 (600)	30 (750)	30 (750)	30 (750)	30 (750)	36 (900)	36 (900)	36 (900)	42 (1050)
7.0 (2.13)	12 (300)	12 (300)	12 (300)	12 (300)	15 (375)	15 (375)	15 (375)	15 (375)	18 (450)	18 (450)	18 (450)	24 (600)	24 (600)	24 (600)	24 (600)	24 (600)	30 (750)	30 (750)	30 (750)	30 (750)	36 (900)	36 (900)	36 (900)	42 (1050)	42 (1050)

NOTE: The design engineer is solely responsible for assessing the bearing resistance (allowable bearing capacity) of the subgrade soils and determining the depth of foundation stone. Subgrade bearing resistance should be assessed with consideration for the range of soil moisture conditions expected under a stormwater system.

FIGURE 10B—MC-4500 Structural Cross Section Detail (Not to Scale)

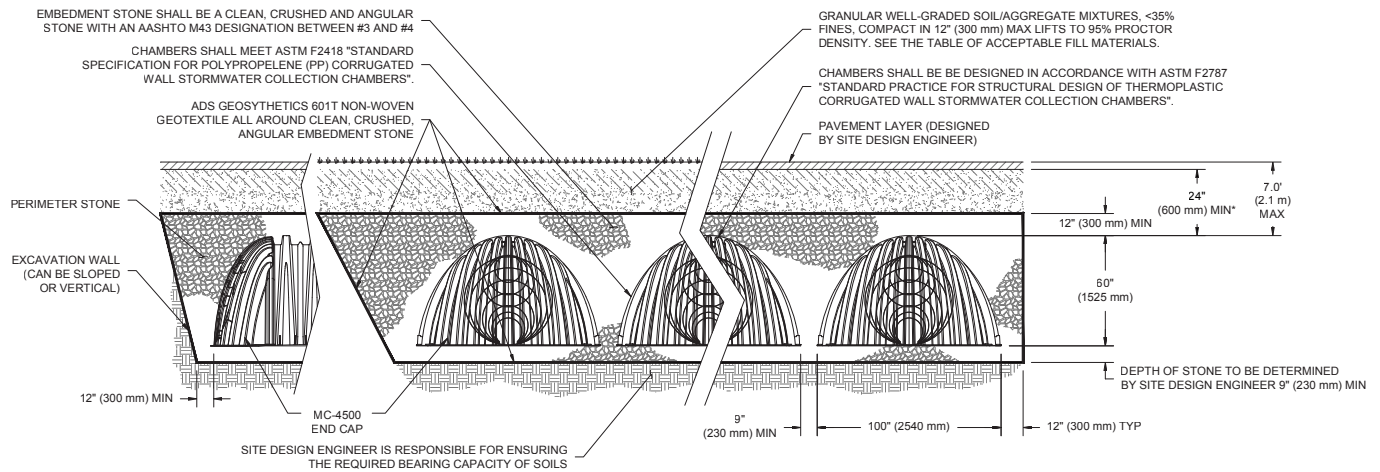

Special applications will be considered on a project by project basis. Please contact our application department should you have a unique application for our team to evaluate.

3.1 Foundation and Embedment Stone

The stone surrounding the chambers consists of the foundation stone below the chambers and embedment stone surrounding the chambers. The foundation stone and embedment stone are important components of the structural system and also provide open void space for stormwater storage. **Table 3** provides the stone specifications that achieve both structural requirements and a porosity of 40% for stormwater storage. **Figure 11** specifies the extents of each backfill stone location.

TABLE 3—Acceptable Fill Materials

MATERIAL LOCATION		DESCRIPTION	AASHTO DESIGNATION	COMPACTION/DENSITY REQUIREMENT
D	FINAL FILL: FILL MATERIAL FOR LAYER 'D' STARTS FROM THE TOP OF THE 'C' LAYER TO THE BOTTOM OF FLEXIBLE PAVEMENT OR UNPAVED FINISHED GRADE ABOVE. NOTE THAT PAVEMENT SUBBASE MAY BE PART OF THE 'D' LAYER	ANY SOIL/ROCK MATERIALS, NATIVE SOILS, OR PER ENGINEER'S PLANS. CHECK PLANS FOR PAVEMENT SUBGRADE REQUIREMENTS.	N/A	PREPARE PER SITE DESIGN ENGINEER'S PLANS. PAVED INSTALLATIONS MAY HAVE STRINGENT MATERIAL AND PREPARATION REQUIREMENTS.
C	INITIAL FILL: FILL MATERIAL FOR LAYER 'C' STARTS FROM THE TOP OF THE EMBEDMENT STONE ('B' LAYER) TO 24" (600 mm) ABOVE THE TOP OF THE CHAMBER. NOTE THAT PAVEMENT SUBBASE MAY BE A PART OF THE 'C' LAYER.	GRANULAR WELL-GRADED SOIL/AGGREGATE MIXTURES, <35% FINES OR PROCESSED AGGREGATE. MOST PAVEMENT SUBBASE MATERIALS CAN BE USED IN LIEU OF THIS LAYER.	AASHTO M145 ¹ A-1,A-2-4,A-3 OR AASHTO M43 ¹ 3, 357, 4, 467, 5, 56, 57, 6, 67, 68, 7, 78, 8, 89, 9, 10	BEGIN COMPACTOINS AFTER 24" (600 mm) OF MATERIAL OVER THE CHAMBERS IS REACHED. COMPACT ADDITIONAL LAYERS IN 12" (300 mm) MAX LIFTS TO A MIN. 95% PROCTOR DENSITY FOR WELL-GRADED MATERIAL AND 95% RELATIVE DENSITY FOR PROCESSED AGGREGATE MATERIALS.
B	EMBEDMENT STONE: FILL SURROUNDING THE CHAMBERS FORM THE FOUDATION STONE ('A' LAYER) TO THE 'C' LAYER ABOVE.	CLEAN, CRUSHED, ANGULAR STONE	AASHTO M43 ¹ 3, 4	NO COMPACTION REQUIRED
A	FOUNDATION STONE: FILL BELOW CHAMBERS FROM THE SUBGRADE UP TO THE FOOT (BOTTOM) OF THE CHAMBER.	CLEAN, CRUSHED, ANGULAR STONE	AASHTO M43 ¹ 3, 4	PLATE COMPACT OR ROLL TO ACHIEVE A FLAT SURFACE. ^{2,3}

PLEASE NOTE:

1. THE LISTED AASHTO DESIGNATIONS ARE FOR GRADATIONS ONLY. THE STONE MUST ALSO BE CLEAN, CRUSHED, ANGULAR. FOR EXAMPLE, A SPECIFICATION FOR #4 STONE WOULD STATE: "CLEAN, CRUSHED, ANGULAR NO. 4 (AASHTO M43) STONE".
2. STORMTECH COMPACTION REQUIREMENTS ARE MET FOR 'A' LOCATION MATERIALS WHEN PLACED AND COMPACTED IN 9" (230 mm) (MAX) LIFTS USING TWO FULL COVERAGES WITH A VIBRATORY COMPACTOR.
3. WHERE INFILTRATION SURFACES MAY BE COMPROMISED BY COMPACTION, FOR STANDARD DESIGN LOAD CONDITIONS, A FLAT SURFACE MAY BE ACHIEVED BY RAKING OR DRAGGING WITHOUT COMPACTION EQUIPMENT. FOR SPECIAL LOAD DESIGNS, CONTACT STORMTECH FOR COMPACTION REQUIREMENTS.

FIGURE 11—Fill Material Locations

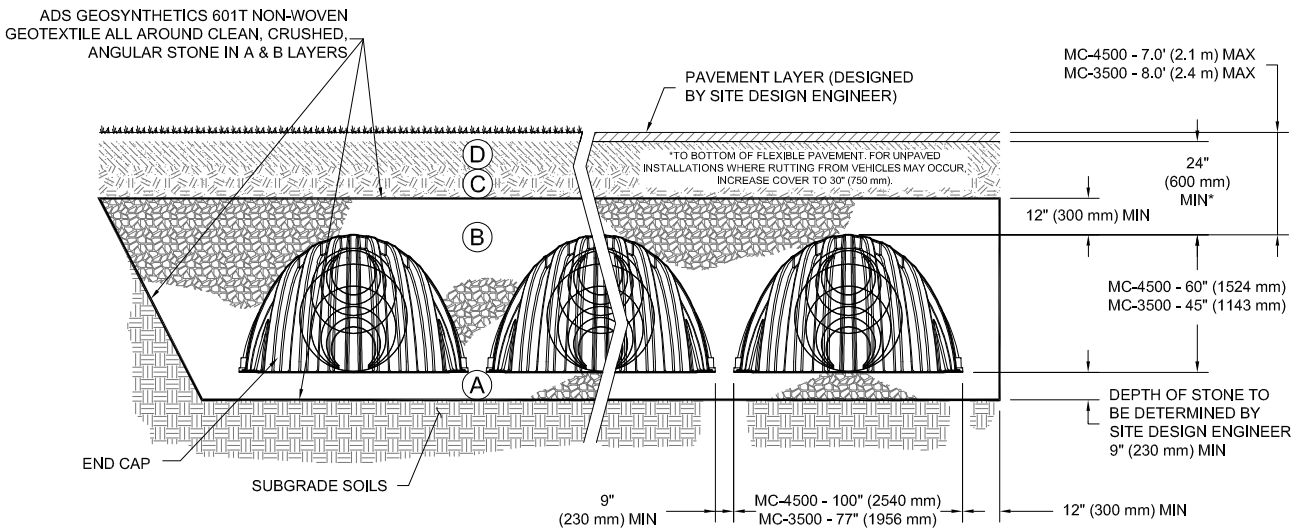

Once layer 'C' is placed, any soil/material can be placed in layer 'D' up to the finished grade. Most pavement subbase soils can be used to replace the materials of layer 'C' or 'D' at the design engineer's discretion.

3.0 Required Materials/Row Separation

3.2 FILL ABOVE CHAMBERS

Refer to **Table 3** and **Figure 11** for acceptable fill material above the clean, crushed, angular stone. StormTech requires a minimum of 24" (600 mm) from the top of the chamber to the bottom of flexible pavement. For non-paved installations where rutting from vehicles may occur StormTech requires a minimum of 30" (750 mm) from top of chamber to finished grade.

3.3 GEOTEXTILE SEPARATION

A non-woven geotextile meeting AASHTO M288 Class 2 separation requirements must be installed to completely envelope the system and prevent soil intrusion into the crushed, angular stone. Overlap adjacent geotextile rolls per AASHTO M288 separation guidelines. Contact StormTech for a list of acceptable geotextiles.

3.4 PARALLEL ROW SEPARATION/ PERPENDICULAR BED SEPARATION

Parallel Row Separation

The minimum installed spacing between parallel rows after backfilling is 9" (230 mm) for the MC-3500 and MC-4500 chambers (measurement taken between the outside edges of the feet). Spacers may be used for layout convenience. Row spacing wider than the minimum spacing above may be specified.

Perpendicular Bed Separation

When beds are laid perpendicular to each other, a minimum installed spacing of 36" (900 mm) between beds is required.

3.5 Special Structural Designs

StormTech engineers may provide special structural designs to enable deeper cover depths or increase the capacity to carry higher live loads. Special designs may utilize the additional strength that can be achieved by compaction of embedment stone or by increasing the spacing between rows.

Increasing the spacing between chamber rows may also facilitate the application of StormTech chambers with either less foundation stone or with weaker subgrade soils. This may be a good option where vertical restrictions on site prevent the use of a deeper foundation.

Contact ADS Engineering Services for more information on special structural designs.



System Cross Section

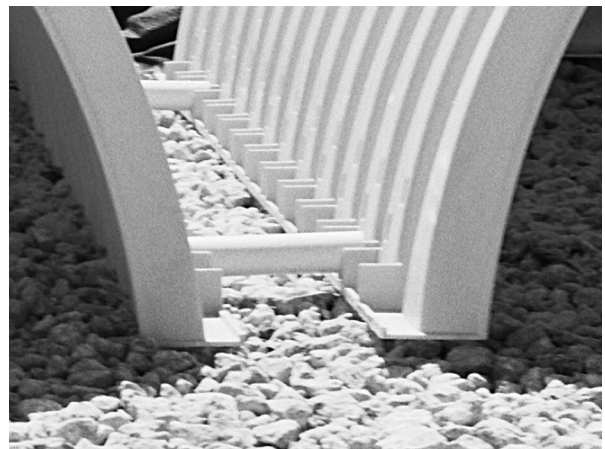

Minimum Row Spacing 9" (230 mm)

4.1 GENERAL

StormTech subsurface chamber systems offer the flexibility for a variety of inlet and outlet configurations. Contact the StormTech Technical Services Department or your local StormTech representative for assistance configuring inlet and outlet connections.

The open graded stone around and under the chambers provides a significant conveyance capacity ranging from approximately 0.8 cfs (23 l/s) to 13 cfs (368 l/s) per MC-3500 chamber and 0.54 cfs (15 l/s) to 8.5 cfs (240 l/s) for the MC-4500 chamber. The actual conveyance capacity is dependent upon stone size, depth of foundation stone and head of water. Although the high conveyance capacity of the open graded stone is an important component of the flow network, StormTech recommends that a system of inlet and outlet manifolds be designed to distribute and convey the peak flow through the chamber system.

It is the responsibility of the design engineer to provide the design flow rates and storage volumes for the stormwater system and to ensure that the final design meets all conveyance and storage requirements. However, StormTech will work with the design engineer to assist with manifold and chamber layouts that meet the design objectives.

4.2 THE ISOLATOR® ROW

The Isolator Row is a patented system that inexpensively captures total suspended solids (TSS) and debris and provides easy access for inspection and maintenance. A double layer of woven geotextile between the bottom of the chambers and the foundation stone provides the filter media that satisfies most contaminant removal objectives. Each installed MC-3500 chamber and MC-3500 end cap provides 42.9 ft² (4.0 m²) and 7.5 ft² (0.7 m²) of bottom filter area respectively. Each installed MC-4500 chamber and MC-4500 end cap provides 30.1 ft² (2.80 m²) and 12.8 ft² (1.19 m²) of bottom filter area respectively.

The Isolator Row can be configured for maintenance objectives or, in some regulatory jurisdictions, for water quality objectives. For water quality applications, Isolator Rows can be sized based on water quality volume or flow rate.

All Isolator Rows require: 1) a manhole for maintenance access, 2) a means of diversion of flows to the Isolator Row and 3) a high flow bypass. Flow diversion can be accomplished by either a weir in the upstream access manhole or simply by feeding the Isolator Row at a lower elevation than the high flow bypass. Contact StormTech for assistance sizing Isolator Rows.

When additional stormwater treatment is required, StormTech systems can be configured using a treatment train approach where other stormwater BMPs are located in series.

FIGURE 12—StormTech Isolator Row Detail

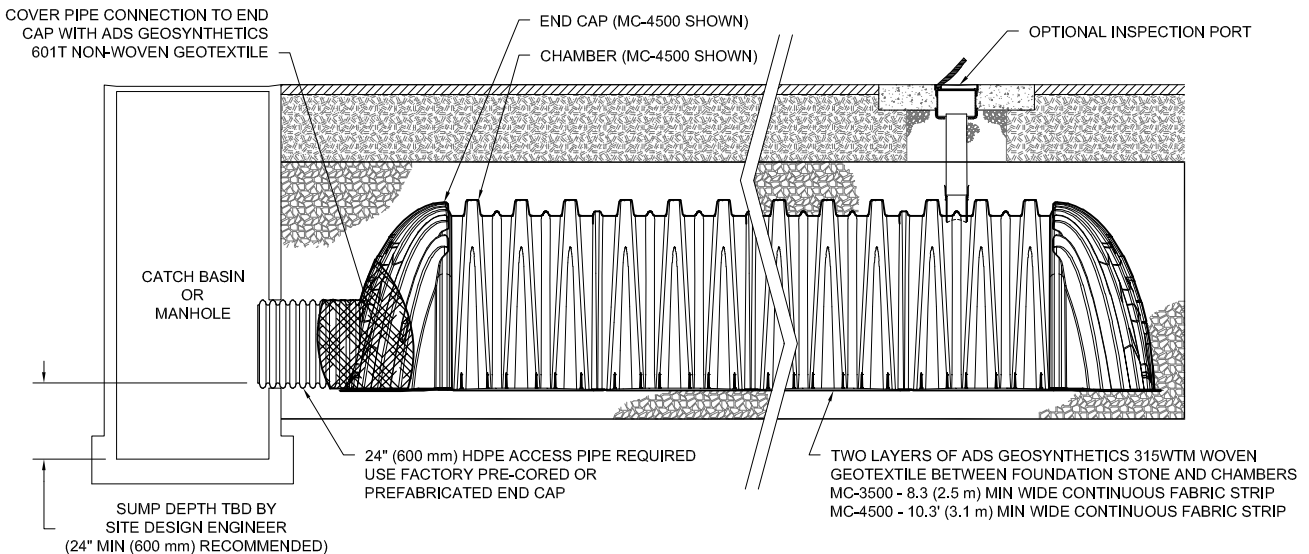

4.0 Hydraulics

FIGURE 13—Typical Inlet Configuration With Isolator Row and Scour Protection

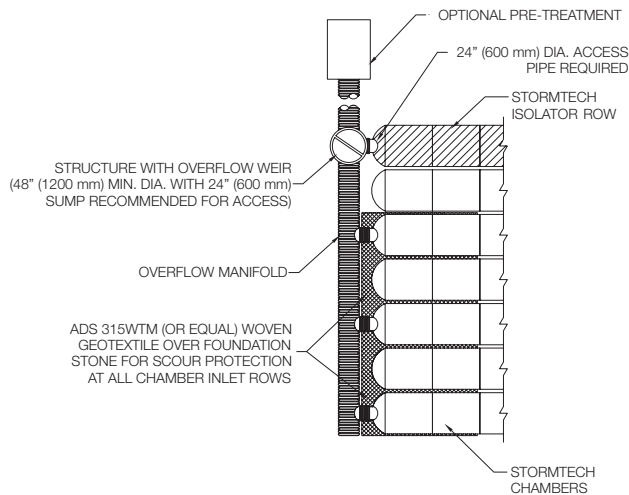

4.3 INLET MANIFOLDS

The primary function of the inlet manifold is to convey and distribute flows to a sufficient number of rows in the chamber bed such that there is ample conveyance capacity to pass the peak flows without creating an unacceptable backwater condition in upstream piping or scour the foundation stone under the chambers.

Manifolds are connected to the end caps either at the top or bottom of the end cap. Standard distances from the base of chamber to the invert of inlet and outlet manifolds connecting to StormTech end caps can be found in table 6. High inlet flow rates from either connection location produce a shear scour potential of the foundation stone. Inlet flows from top inlets also produce impingement scour potential. Scour potential is reduced when standing water is present over the foundation stone. However, for safe design across the wide range of applications, StormTech assumes minimal standing water at the time the design flow occurs.

To minimize scour potential, StormTech recommends the installation of woven scour protection fabric at each inlet row. This enables a protected transition zone from the concentrated flow coming out of the inlet pipe to a uniform flow across the entire width of the chamber for both top and bottom connections.

Allowable flow rates for design are dependent upon: the elevation of inlet pipe, foundation stone size and scour protection. With an appropriate scour protection geotextile installed from the end cap to at least 14.5 ft (4.42 m) in front of the inlet pipe for the MC-3500 and for the MC-4500, for both top and bottom feeds, the flow rates listed in **Table 4** can be used for all StormTech specified foundation stone gradations.

*See StormTech's Tech Sheet #7 for manifold sizing guidance.

Table 4—Allowable Inlet Flows*

Inlet Pipe Diameter Inches (mm)	Allowable Maximum Flow Rate cfs (l/s)
12 (300)	2.48 (70)
15 (375)	3.5 (99)
18 (450)	5.5 (156)
24 (600)	8.5 (241) [MC-3500]
24 (600)	9.5 (269) [MC-4500]

*Assumes appropriate length of scour fabric per section 4.3

Table 5—Maximum Outlet Flow Rate Capacities From StormTech Outlet Manifolds

PIPE DIA.	FLOW (CFS)	FLOW (L/S)
6" (150 mm)	0.4	11.3
8" (200 mm)	0.7	19.8
10" (250 mm)	1.0	28.3
12" (300 mm)	2.0	56.6
15" (375 mm)	2.7	76.5
18" (450 mm)	4.0	113.3
24" (600 mm)	7.0	198.2
30" (750 mm)	11.0	311.5
36" (900 mm)	16.0	453.1
42" (1050 mm)	22.0	623.0
48" (1200 mm)	28.0	792.9

Table 6—Standard Distances From Base of Chamber to Invert of Inlet and Outlet Manifolds on StormTech End Caps

MC-3500 ENDCAPS			
	PIPE DIA.	INV. (IN)	INV. (MM)
TOP	6" (150 mm)	33.21	841
	8" (200 mm)	31.16	789
	10" (250 mm)	29.04	738
	12" (300 mm)	26.36	671
	15" (375 mm)	23.39	594
	18" (450 mm)	20.03	509
BOTTOM	24" (600 mm)	14.48	369
	12" (750 mm)	1.35	34
	15" (900 mm)	1.5	40
	18" (1050 mm)	1.77	46
24" (1200 mm)	2.06	52	
MC-4500 ENDCAPS			
	PIPE DIA.	INV. (IN)	INV. (MM)
	12" (300 mm)	35.69	907
	15" (375 mm)	32.72	831
	18" (450 mm)	29.36	746
	24" (600 mm)	23.05	585
BOTTOM	12" (750 mm)	1.55	34
	15" (900 mm)	1.7	43
	18" (1050 mm)	1.97	50
	24" (1200 mm)	2.26	57

4.4 OUTLET MANIFOLDS

The primary function of the outlet manifold is to convey peak flows from the chamber system to the outlet control structure. Outlet manifolds are often sized for attenuated flows. They may be smaller in diameter and have fewer row connections than inlet manifolds. In some applications however, the intent of the outlet piping is to convey an unattenuated bypass flow rate and manifolds may be sized similar to inlet manifolds.

Since chambers are generally flowing at or near full at the time of the peak outlet flow rate, scour is generally not governing and outlet manifold sizing is based on pipe flow equations. In most cases, StormTech recommends that outlet manifolds connect the same rows that are connected to an inlet manifold. This provides a continuous flow path through open conduits to pass the peak flow without dependence on passing peak flows through stone.

The primary function of the underdrains is to draw down water stored in the stone below the invert of the manifold. Underdrains are generally not sized for conveyance of the peak flow.

4.5 INSERTA TEE INLET CONNECTIONS

The maximum outlet flow rate capacities from StormTech outlet manifolds can be found in **Table 5**.

FIGURE 14—Typical Inlet, Outlet and Underdrain Configuration

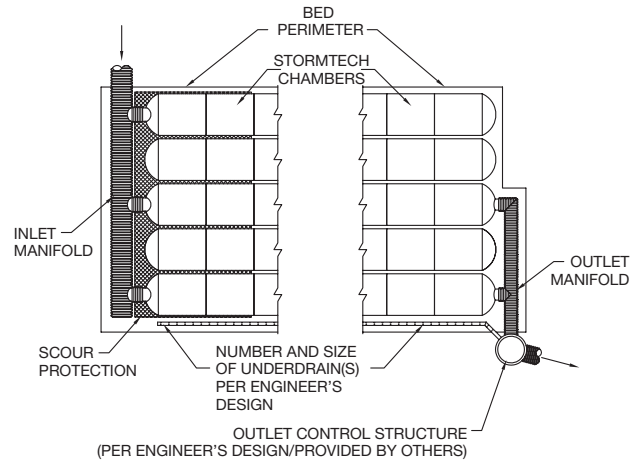
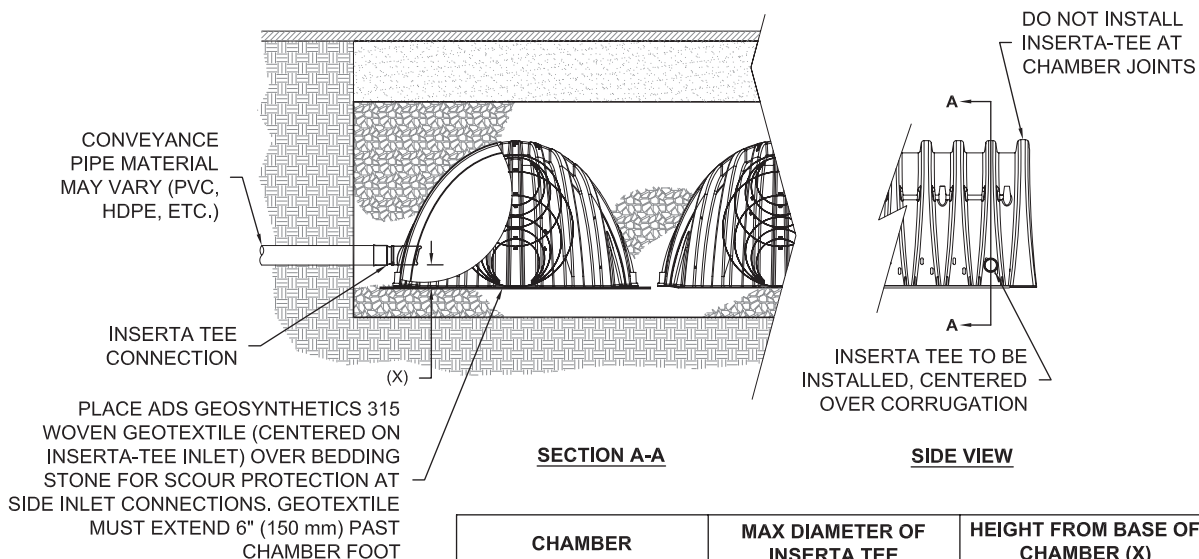

FIGURE 15—Inserta Tee Detail



PLACE ADS GEOSYNTHETICS 315 WOVEN GEOTEXTILE (CENTERED ON INSERTA-TEE INLET) OVER BEDDING STONE FOR SCOUR PROTECTION AT SIDE INLET CONNECTIONS. GEOTEXTILE MUST EXTEND 6" (150 mm) PAST CHAMBER FOOT

NOTE:
PART NUMBERS WILL VARY BASED ON INLET PIPE MATERIALS. CONTACT STORMTECH FOR MORE INFORMATION.

CHAMBER	MAX DIAMETER OF INSERTA TEE	HEIGHT FROM BASE OF CHAMBER (X)
MC-3500	12" (250 mm)	6" (150 mm)
MC-4500	12" (250 mm)	8" (200 mm)
INSERTA TEE FITTINGS AVAILABLE FOR SDR 26, SDR 35, SCH 40 IPS GASKETED & SOLVENT WELD, N-12, HP STORM, C-900 OR DUCTILE IRON		

5.0 Cumulative Storage Volumes



Tables 7 and 8 provide cumulative storage volumes for the MC-3500 chamber and end cap. These tables can be used to calculate the stage-storage relationship for the retention or detention system. Digital spreadsheets in which the number of chambers and end caps can be input for quick

cumulative storage calculations are available at www.stormtech.com. For assistance with site-specific calculations or input into routing software, contact the StormTech Technical Services Department.

TABLE 7 – MC-3500 Incremental Storage Volume Per Chamber

Assumes 40% stone porosity. Calculations are based upon a 9" (230 mm) stone base under the chambers, 12" (300 mm) of stone above chambers, and 9" (230 mm) of spacing between chambers.

Depth of Water in System Inches (mm)	Cumulative Chamber Storage ft ³ (m ³)	Total System Cumulative Storage ft ³ (m ³)
66 (1676)	0.00	178.96 (5.068)
65 (1651)	0.00	177.25 (5.019)
64 (1626)	0.00	175.54 (4.971)
63 (1600)	Stone 0.00	173.83 (4.922)
62 (1575)	Cover 0.00	172.11 (4.874)
61 (1549)	0.00	170.40 (4.825)
60 (1524)	0.00	168.69 (4.777)
59 (1499)	0.00	166.98 (4.728)
58 (1473)	0.00	165.27 (4.680)
57 (1448)	0.00	163.55 (4.631)
56 (1422)	0.00	161.84 (4.583)
55 (1397)	0.00	160.13 (4.534)
54 (1372)	109.95 (3.113)	158.42 (4.486)
53 (1346)	109.89 (3.112)	156.67 (4.436)
52 (1321)	109.69 (3.106)	154.84 (4.385)
51 (1295)	109.40 (3.098)	152.95 (4.331)
50 (1270)	109.00 (3.086)	151.00 (4.276)
49 (1245)	108.31 (3.067)	148.88 (4.216)
48 (1219)	107.28 (3.038)	146.55 (4.150)
47 (1194)	106.03 (3.003)	144.09 (4.080)
46 (1168)	104.61 (2.962)	141.52 (4.007)
45 (1143)	103.04 (2.918)	138.86 (3.932)
44 (1118)	101.33 (2.869)	136.13 (3.855)
43 (1092)	99.50 (2.818)	133.32 (3.775)
42 (1067)	97.56 (2.763)	130.44 (3.694)
41 (1041)	95.52 (2.705)	127.51 (3.611)
40 (1016)	93.39 (2.644)	124.51 (3.526)
39 (991)	91.16 (2.581)	121.47 (3.440)
38 (965)	88.86 (2.516)	118.37 (3.352)
37 (948)	86.47 (2.449)	115.23 (3.263)
36 (914)	84.01 (2.379)	112.04 (3.173)
35 (889)	81.49 (2.307)	108.81 (3.081)
34 (864)	78.89 (2.234)	105.54 (2.989)
33 (838)	76.24 (2.159)	102.24 (2.895)

Depth of Water in System Inches (mm)	Cumulative Chamber Storage ft ³ (m ³)	Total System Cumulative Storage ft ³ (m ³)
32 (813)	73.52 (2.082)	98.90 (2.800)
31 (787)	70.75 (2.003)	95.52 (2.705)
30 (762)	67.92 (1.923)	92.12 (2.608)
29 (737)	65.05 (1.842)	88.68 (2.511)
28 (711)	62.12 (1.759)	85.21 (2.413)
27 (686)	59.15 (1.675)	81.72 (2.314)
26 (680)	56.14 (1.590)	78.20 (2.214)
25 (635)	53.09 (1.503)	74.65 (2.114)
24 (610)	49.99 (1.416)	71.09 (2.013)
23 (584)	46.86 (1.327)	67.50 (1.911)
22 (559)	43.70 (1.237)	63.88 (1.809)
21 (533)	40.50 (1.147)	60.25 (1.706)
20 (508)	37.27 (1.055)	56.60 (1.603)
19 (483)	34.01 (0.963)	52.93 (1.499)
18 (457)	30.72 (0.870)	49.25 (1.395)
17 (432)	27.40 (0.776)	45.54 (1.290)
16 (406)	24.05 (0.681)	41.83 (1.184)
15 (381)	20.69 (0.586)	38.09 (1.079)
14 (356)	17.29 (0.490)	34.34 (0.973)
13 (330)	13.88 (0.393)	30.58 (0.866)
12 (305)	10.44 (0.296)	26.81 (0.759)
11 (279)	6.98 (0.198)	23.02 (0.652)
10 (254)	3.51 (0.099)	19.22 (0.544)
9 (229)	0.00	15.41 (0.436)
8 (203)	0.00	13.70 (0.388)
7 (178)	0.00	11.98 (0.339)
6 (152)	Stone 0.00	10.27 (0.291)
5 (127)	Foundation 0.00	8.56 (0.242)
4 (102)	0.00	6.85 (0.194)
3 (76)	0.00	5.14 (0.145)
2 (51)	0.00	3.42 (0.097)
1 (25)	0.00	1.71 (0.048)

NOTE: Add 1.71 ft³ (0.030 m³) of storage for each additional inch (25 mm) of stone foundation. Contact StormTech for cumulative volume spreadsheets in digital format.

5.0 Cumulative Storage Volume



TABLE 8 – MC-3500 Incremental Storage Volume Per End Cap

Assumes 40% stone porosity. Calculations are based upon a 9" (230 mm) stone base under the chambers, 12" (300 mm) of stone above end caps, and 9" (230 mm) of spacing between end caps and 6" (150 mm) of stone perimeter.

Depth of Water in System Inches (mm)	Cumulative End Cap Storage ft ³ (m ³)	Total System Cumulative Storage ft ³ (m ³)
66 (1676)	0.00	46.96 (1.330)
65 (1651)	0.00	46.39 (1.314)
64 (1626)	0.00	45.82 (1.298)
63 (1600)	Stone	45.25 (1.281)
62 (1575)	Cover	44.68 (1.265)
61 (1549)	0.00	44.11 (1.249)
60 (1524)	0.00	43.54 (1.233)
59 (1499)	0.00	42.98 (1.217)
58 (1473)	0.00	42.41 (1.201)
57 (1448)	0.00	41.84 (1.185)
56 (1422)	0.00	41.27 (1.169)
55 (1397)	0.00	40.70 (1.152)
54 (1372)	15.64 (0.443)	40.13 (1.136)
53 (1346)	15.64 (0.443)	39.56 (1.120)
52 (1321)	15.63 (0.443)	38.99 (1.104)
51 (1295)	15.62 (0.442)	38.41 (1.088)
50 (1270)	15.60 (0.442)	37.83 (1.071)
49 (1245)	15.56 (0.441)	37.24 (1.054)
48 (1219)	15.51 (0.439)	36.64 (1.037)
47 (1194)	15.44 (0.437)	36.02 (1.020)
46 (1168)	15.35 (0.435)	35.40 (1.003)
45 (1143)	15.25 (0.432)	34.77 (0.985)
44 (1118)	15.13 (0.428)	34.13 (0.966)
43 (1092)	14.99 (0.424)	33.48 (0.948)
42 (1067)	14.83 (0.420)	32.81 (0.929)
41 (1041)	14.65 (0.415)	32.13 (0.910)
40 (1016)	14.45 (0.409)	31.45 (0.890)
39 (991)	14.24 (0.403)	30.75 (0.871)
38 (965)	14.00 (0.396)	30.03 (0.850)
37 (948)	13.74 (0.389)	29.31 (0.830)
36 (914)	13.47 (0.381)	28.58 (0.809)
35 (889)	13.18 (0.373)	27.84 (0.788)
34 (864)	12.86 (0.364)	27.08 (0.767)

Depth of Water in System Inches (mm)	Cumulative Chamber Storage ft ³ (m ³)	Total System Cumulative Storage ft ³ (m ³)
33 (838)	12.53 (0.355)	26.30 (0.745)
32 (813)	12.18 (0.345)	25.53 (0.723)
31 (787)	11.81 (0.335)	24.74 (0.701)
30 (762)	11.42 (0.323)	23.93 (0.678)
29 (737)	11.01 (0.312)	23.12 (0.655)
28 (711)	10.58 (0.300)	22.29 (0.631)
27 (686)	10.13 (0.287)	21.45 (0.607)
26 (680)	9.67 (0.274)	20.61 (0.583)
25 (635)	9.19 (0.260)	19.75 (0.559)
24 (610)	8.70 (0.246)	18.88 (0.559)
23 (584)	8.19 (0.232)	18.01 (0.510)
22 (559)	7.67 (0.217)	17.13 (0.485)
21 (533)	7.13 (0.202)	16.24 (0.460)
20 (508)	6.59 (0.187)	15.34 (0.434)
19 (483)	6.03 (0.171)	14.43 (0.409)
18 (457)	5.46 (0.155)	13.52 (0.383)
17 (432)	4.88 (0.138)	12.61 (0.357)
16 (406)	4.30 (0.122)	11.69 (0.331)
15 (381)	3.70 (0.105)	10.76 (0.305)
14 (356)	3.10 (0.088)	9.83 (0.278)
13 (330)	2.49 (0.071)	8.90 (0.252)
12 (305)	1.88 (0.053)	7.96 (0.225)
11 (279)	1.26 (0.036)	7.02 (0.199)
10 (254)	0.63 (0.018)	6.07 (0.172)
9 (229)	0.00	5.12 (0.145)
8 (203)	0.00	4.55 (0.129)
7 (178)	0.00	3.99 (0.113)
6 (152)	Stone	3.42 (0.097)
5 (127)	Foundation	2.85 (0.081)
4 (102)	0.00	2.28 (0.064)
3 (76)	0.00	1.71 (0.048)
2 (51)	0.00	1.14 (0.032)
1 (25)	0.00	0.56 (0.016)

NOTE: Add 0.56 ft³ (0.016 m³) of storage for each additional inch (25 mm) of stone foundation. Contact StormTech for cumulative volume spreadsheets in digital format.

5.0 Cumulative Storage Volumes



Tables 9 and 10 provide cumulative storage volumes for the MC-4500 chamber and end cap. These tables can be used to calculate the stage-storage relationship for the retention or detention system. Digital spreadsheets in which the number of chambers and end caps can be input for quick

cumulative storage calculations are available at www.stormtech.com. For assistance with site-specific calculations or input into routing software, contact the StormTech Technical Services Department.

TABLE 9 – MC-4500 Incremental Storage Volume Per Chamber

Assumes 40% stone porosity. Calculations are based upon a 9" (230 mm) stone base under the chambers, 12" (300 mm) of stone above chambers, and 9" (230 mm) of spacing between chambers.

Depth of Water in System Inches (mm)	Cumulative Chamber Storage ft ³ (m ³)	Total System Cumulative Storage ft ³ (m ³)
81 (2057)	0.00	162.62 (4.065)
80 (2032)	0.00	161.40 (4.570)
79 (2007)	0.00	160.18 (4.536)
78 (1981)	Stone 0.00	158.98 (4.501)
77 (1956)	Cover 0.00	157.74 (4.467)
76 (1930)	0.00	156.62 (4.432)
75 (1905)	0.00	155.30 (4.398)
74 (1880)	0.00	154.09 (4.363)
73 (1854)	0.00	152.87 (4.329)
72 (1829)	0.00	151.65 (4.294)
71 (1803)	0.00	150.43 (4.294)
70 (1778)	0.00	149.21 (4.225)
69 (1753)	106.51 (3.016)	147.99 (4.191)
68 (1727)	106.47 (3.015)	146.75 (4.156)
67 (1702)	106.35 (3.012)	145.46 (4.119)
66 (1676)	106.18 (3.007)	144.14 (4.082)
65 (1651)	105.98 (3.001)	142.80 (4.044)
64 (1626)	105.71 (2.993)	141.42 (4.005)
63 (1600)	105.25 (2.981)	139.93 (3.962)
62 (1575)	104.59 (2.962)	138.31 (3.917)
61 (1549)	103.79 (2.939)	136.61 (3.869)
60 (1524)	102.88 (2.913)	134.85 (3.819)
59 (1499)	101.88 (2.885)	133.03 (3.767)
58 (1473)	100.79 (2.854)	131.16 (3.714)
57 (1448)	99.63 (2.821)	129.24 (3.660)
56 (1422)	98.39 (2.786)	127.28 (3.604)
55 (1397)	97.10 (2.749)	125.28 (3.548)
54 (1372)	95.73 (2.711)	123.25 (3.490)
53 (1346)	94.32 (2.671)	121.18 (3.490)
52 (1321)	92.84 (2.629)	119.08 (3.372)
51 (1295)	91.32 (2.586)	116.94 (3.311)
50 (1270)	89.74 (2.541)	114.78 (3.250)
49 (1245)	88.12 (2.495)	112.59 (3.188)
48 (1219)	86.45 (2.448)	110.37 (3.125)
47 (1194)	84.75 (2.400)	108.13 (3.062)
46 (1168)	83.00 (2.350)	105.86 (2.998)
45 (1143)	81.21 (2.300)	103.56 (2.933)
44 (1118)	79.38 (2.248)	101.25 (2.867)
43 (1092)	77.52 (2.195)	98.91 (2.801)

NOTE: Add 1.22 ft³ (0.035 m³) of storage for each additional inch (25 mm) of stone foundation. Contact StormTech for cumulative volume spreadsheets in digital format.

Depth of Water in System Inches (mm)	Cumulative Chamber Storage ft ³ (m ³)	Total System Cumulative Storage ft ³ (m ³)
42 (1067)	75.62 (2.141)	96.55 (2.734)
41 (1041)	73.69 (2.087)	94.18 (2.667)
40 (1016)	71.72 (2.031)	91.78 (2.599)
39 (991)	69.73 (1.974)	89.36 (2.531)
38 (965)	67.70 (1.917)	86.93 (2.462)
37 (948)	65.65 (1.859)	84.48 (2.392)
36 (914)	63.57 (1.800)	82.01 (2.322)
35 (889)	61.46 (1.740)	79.53 (2.252)
34 (864)	59.32 (1.680)	77.03 (2.181)
33 (838)	57.17 (1.619)	74.52 (2.110)
32 (813)	54.98 (1.557)	71.99 (2.038)
31 (787)	52.78 (1.495)	69.45 (1.966)
30 (762)	50.55 (1.431)	66.89 (1.894)
29 (737)	48.30 (1.368)	64.32 (1.821)
28 (711)	46.03 (1.303)	61.74 (1.748)
27 (686)	43.74 (1.239)	59.19 (1.675)
26 (680)	41.43 (1.173)	56.55 (1.601)
25 (610)	39.11 (1.107)	53.93 (1.527)
24 (609)	36.77 (1.041)	51.31 (1.453)
23 (584)	34.41 (0.974)	48.67 (1.378)
22 (559)	32.03 (0.907)	46.03 (1.303)
21 (533)	29.64 (0.839)	43.38 (1.228)
20 (508)	27.23 (0.771)	40.71 (1.153)
19 (483)	24.81 (0.703)	38.04 (1.077)
18 (457)	22.38 (0.634)	35.37 (1.001)
17 (432)	19.94 (0.565)	32.68 (0.925)
16 (406)	17.48 (0.495)	29.99 (0.849)
15 (381)	15.01 (0.425)	27.29 (0.773)
14 (356)	12.53 (0.355)	24.58 (0.696)
13 (330)	10.05 (0.284)	21.87 (0.619)
12 (305)	7.55 (0.214)	19.15 (0.542)
11 (279)	5.04 (0.143)	16.43 (0.465)
10 (254)	2.53 (0.072)	13.70 (0.388)
9 (229)	0.00	10.97 (0.311)
8 (203)	0.00	9.75 (0.276)
7 (178)	0.00	8.53 (0.242)
6 (152)	Stone 0.00	7.31 (0.207)
5 (127)	Foundation 0.00	6.09 (0.173)
4 (102)	0.00	4.87 (0.138)
3 (76)	0.00	3.66 (0.104)
2 (51)	0.00	2.44 (0.069)
1 (25)	0.00	1.22 (0.035)

5.0 Cumulative Storage Volumes



TABLE 10 – MC-4500 Incremental Storage Volume Per End Cap

Assumes 40% stone porosity. Calculations are based upon a 9" (230 mm) stone base under the chambers, 12" (300 mm) of stone above end caps, and 9" (230 mm) of spacing between end caps and 6" (150 mm) of stone perimeter.

Depth of Water in System Inches (mm)	Cumulative End Cap Storage ft ³ (m ³)	Total System Cumulative Storage ft ³ (m ³)
81 (2057)	↑ 0.00	108.69 (3.078)
80 (2032)	0.00	107.62 (3.047)
79 (2007)	0.00	106.54 (3.017)
78 (1981)	Stone 0.00	105.46 (2.986)
77 (1956)	Cover 0.00	104.38 (2.956)
76 (1930)	↓ 0.00	103.31 (2.925)
75 (1905)	0.00	102.23 (2.895)
74 (1880)	0.00	101.15 (2.864)
73 (1854)	0.00	100.07 (2.834)
72 (1829)	0.00	99.00 (2.803)
71 (1803)	0.00	97.92 (2.773)
70 (1778)	↓ 0.00	96.84 (2.742)
69 (1753)	35.71 (1.011)	95.76 (2.712)
68 (1727)	35.71 (1.011)	94.69 (2.681)
67 (1702)	35.70 (1.011)	93.60 (2.651)
66 (1676)	35.67 (1.010)	92.51 (2.620)
65 (1651)	35.62 (1.009)	91.40 (2.588)
64 (1626)	35.56 (1.007)	90.29 (2.557)
63 (1600)	35.47 (1.004)	89.16 (2.525)
62 (1575)	35.36 (1.001)	88.01 (2.492)
61 (1549)	35.21 (0.997)	86.85 (2.459)
60 (1524)	35.05 (0.992)	85.67 (2.426)
59 (1499)	34.86 (0.987)	84.48 (2.392)
58 (1473)	34.64 (0.981)	83.27 (2.358)
57 (1448)	34.40 (0.974)	82.05 (2.323)
56 (1422)	34.13 (0.966)	80.81 (2.288)
55 (1397)	33.83 (0.958)	79.55 (2.253)
54 (1372)	33.51 (0.949)	78.28 (2.217)
53 (1346)	33.16 (0.939)	77.00 (2.180)
52 (1321)	32.79 (0.928)	75.70 (2.144)
51 (1295)	32.39 (0.917)	74.38 (2.106)
50 (1270)	31.98 (0.906)	73.06 (2.069)
49 (1245)	31.54 (0.893)	71.71 (2.031)
48 (1219)	31.07 (0.880)	70.36 (1.992)
47 (1194)	30.59 (0.866)	68.99 (1.954)
46 (1168)	30.09 (0.852)	67.61 (1.915)
45 (1143)	29.56 (0.837)	66.22 (1.875)
44 (1118)	29.02 (0.822)	64.81 (1.835)
43 (1092)	28.45 (0.806)	63.40 (1.795)

NOTE: Add 1.08 ft³ (0.031 m³) of storage for each additional inch (25 mm) of stone foundation. Contact StormTech for cumulative volume spreadsheets in digital format.

Depth of Water in System Inches (mm)	Cumulative Chamber Storage ft ³ (m ³)	Total System Cumulative Storage ft ³ (m ³)
42 (1067)	27.87 (0.789)	61.97 (1.755)
41 (1041)	27.27 (0.772)	60.53 (1.714)
40 (1016)	26.65 (0.755)	59.08 (1.673)
39 (991)	26.01 (0.736)	57.62 (1.632)
38 (965)	25.35 (0.718)	56.15 (1.590)
37 (948)	24.68 (0.699)	54.67 (1.548)
36 (914)	23.99 (0.679)	53.18 (1.506)
35 (889)	23.28 (0.659)	51.68 (1.463)
34 (864)	22.56 (0.639)	50.17 (1.421)
33 (838)	21.82 (0.618)	48.64 (1.377)
32 (813)	21.06 (0.596)	47.11 (1.334)
31 (787)	20.29 (0.575)	45.57 (1.290)
30 (762)	19.50 (0.552)	44.02 (1.247)
29 (737)	18.70 (0.530)	42.46 (1.202)
28 (711)	17.88 (0.506)	40.89 (1.158)
27 (686)	17.04 (0.483)	39.31 (1.113)
26 (680)	16.19 (0.459)	37.73 (1.068)
25 (610)	15.33 (0.434)	36.14 (1.023)
24 (609)	14.46 (0.410)	34.53 (0.978)
23 (584)	13.58 (0.384)	32.93 (0.932)
22 (559)	12.68 (0.359)	31.31 (0.887)
21 (533)	11.77 (0.333)	29.69 (0.841)
20 (508)	10.85 (0.307)	28.06 (0.794)
19 (483)	9.91 (0.281)	26.42 (0.748)
18 (457)	8.97 (0.254)	24.77 (0.702)
17 (432)	8.01 (0.227)	23.12 (0.655)
16 (406)	7.04 (0.199)	21.46 (0.608)
15 (381)	6.07 (0.172)	19.80 (0.561)
14 (356)	5.08 (0.144)	18.13 (0.513)
13 (330)	4.08 (0.116)	16.45 (0.466)
12 (305)	3.07 (0.087)	14.77 (0.418)
11 (279)	2.06 (0.058)	13.09 (0.371)
10 (254)	1.03 (0.029)	11.39 (0.323)
9 (229)	↑ 0.00	9.70 (0.275)
8 (203)	0.00	8.62 (0.244)
7 (178)	0.00	7.54 (0.214)
6 (152)	Stone 0.00	6.46 (0.183)
5 (127)	Foundation 0.00	5.39 (0.153)
4 (102)	↓ 0.00	4.31 (0.122)
3 (76)	0.00	3.23 (0.092)
2 (51)	0.00	2.15 (0.061)
1 (25)	↓ 0.00	1.08 (0.031)

The following steps provide the calculations necessary for preliminary sizing of an MC-3500 chamber system. For custom bed configurations to fit specific sites, contact the StormTech Technical Services Department or your local StormTech representative.

1) Determine the amount of storage volume (VS) required. It is the design engineer's sole responsibility to determine the storage volume required.

TABLE 11—Storage Volume Per Chamber/End Cap ft³ (m³)

	Bare Unit Storage ft ³ (m ³)	Chamber/End Cap and Stone Volume — Stone Foundation Depth in. (mm)			
		9 (230)	12 (300)	15 (375)	18 (450)
MC-3500 Chamber	109.9 (3.11)	178.9 (5.06)	184.0 (5.21)	189.2 (5.36)	194.3 (5.5)
MC-3500 End Cap	14.9 (0.42)	46.0 (1.30)	47.7 (1.35)	49.4 (1.40)	51.1 (1.45)

NOTE: Assumes 9" (230 mm) row spacing, 40% stone porosity, 12" (300 mm) stone above and includes the bare chamber/end cap volume. End cap volume assumes 6" (150 mm) stone perimeter.

2) Determine the number of chambers (C) required.

To calculate the number of chambers required for adequate storage, divide the storage volume (Vs) by the storage volume of the chamber (from **Table 11**), as follows: **C = Vs / Storage Volume per Chamber**

3) Determine the number of end caps required.

The number of end caps (EC) required depends on the number of rows required by the project. Once the number of chamber rows is determined, multiply the number of chamber rows by 2 to determine the number of end caps required. **EC = No. of Chamber Rows x 2**

NOTE: Additional end caps may be required for systems having inlet locations within the chamber bed.

4) Determine additional storage provided by end caps.

End Caps will provide additional storage to the project. Multiply the number of end caps (EC) by the storage volume per end cap (ECS) to determine the additional storage (As) provided by the end caps. **As = EC x ECS**

5) Adjust number of chambers (C) to account for additional end cap storage (As). The original number of chambers (C) can now be reduced due to the additional storage in the end caps. Divide the additional storage (As) by the storage volume per chamber to determine the number of chambers that can be removed. **Number of chambers to remove = As/ volume per chamber**

NOTE: Additional storage exists in the stone perimeter as well as in the inlet and outlet manifold systems. Contact StormTech's Technical Services Department for assistance with determining the number of chambers and end caps required for your project.

6) Determine the required bed size (S).

The size of the bed will depend on the number of chambers and end caps required:

MC-3500 area per chamber = 51.4 ft² (4.8 m²)

MC-3500 area per end cap = 13.5 ft² (1.3 m²)

S = (C x area per chamber) + (EC x area per end cap)

NOTE: It is necessary to add 12" (300 mm) of stone perimeter parallel to the chamber rows and 6" (150 mm) of stone perimeter from the base of all end caps. The additional area due to perimeter stone is not included in the area numbers above.

7) Determine the amount of stone (Vst) required.

To calculate the total amount of clean, crushed, angular stone required, multiply the number of chambers (C) and the number of end caps (EC) by the selected weight of stone from **Table 12**.

NOTE: Clean, crushed, angular stone is also required around the perimeter of the system.

TABLE 12—Amount of Stone Per Chamber/End Cap

ENGLISH tons (yd ³)	Stone Foundation Depth			
	9"	12"	15"	18"
MC-3500	9.1 (6.4)	9.7 (6.9)	10.4 (7.3)	11.1 (7.8)
End Cap	4.1 (2.9)	4.3 (3.1)	4.6 (3.2)	4.8 (3.4)
METRIC kg (m ³)	230 mm	300 mm	375 mm	450 mm
MC-3500	8220 (4.9)	8831 (5.3)	9443 (5.6)	10054 (6.0)
End Cap	3699 (2.2)	3900 (2.3)	4100 (2.5)	4301 (2.6)

NOTE: Assumes 12" (300 mm) of stone above, and 9" (230 mm) row spacing, and 6" (150 mm) of perimeter stone in front of end caps.

8) Determine the volume of excavation (Ex) required.

Each additional foot of cover will add a volume of excavation of 1.9 yd³ (1.5 m³) per MC-3500 chamber and

TABLE 13—Volume of Excavation Per Chamber/End Cap yd³ (m³)

	Stone Foundation Depth			
	9" (230 mm)	12" (300 mm)	15"(375 mm)	18"(450 mm)
MC-3500	12.4 (9.5)	12.8 (9.8)	13.3 (10.2)	13.8 (10.5)
End Cap	4.1 (3.1)	4.3 (3.3)	4.4 (3.4)	4.5 (3.5)

NOTE: Assumes 9" (230 mm) separation between chamber rows, 6" (150 mm) of perimeter in front of end caps, and 24" (600 mm) of cover. The volume of excavation will vary as the depth of cover increases.

0.6 yd³ (0.5 m³) per MC-3500 end cap.

9) Determine the area of geotextile (F) required.

The bottom, top and sides of the bed must be covered with a non-woven geotextile (filter fabric) that meets AASHTO M288 Class 2 requirements. The area of the sidewalls must be calculated and a 24" (600 mm) overlap must be included for all seams. Geotextiles typically come in 15 foot (4.57 m) wide rolls.

The following steps provide the calculations necessary for preliminary sizing of an MC-4500 chamber system. For custom bed configurations to fit specific sites, contact the StormTech Technical Services Department or your local StormTech representative.

1) Determine the amount of storage volume (VS) required. It is the design engineer’s sole responsibility to determine the storage volume required.

TABLE 14—Storage Volume Per Chamber/End Cap ft³ (m³)

	Bare Unit Storage ft ³ (m ³)	Chamber/End Cap and Stone Volume — Stone Foundation Depth in. (mm)			
		9 (230)	12 (300)	15 (375)	18 (450)
MC-4500 Chamber	106.5 (3.01)	162.6 (4.60)	166.3 (4.71)	169.9 (4.81)	173.6 (4.91)
MC-4500 End Cap	35.7 (1.01)	108.7 (3.08)	111.9 (3.17)	115.2 (3.26)	118.4 (3.35)

NOTE: Assumes 9" (230 mm) row spacing, 40% stone porosity, 12" (300 mm) stone above and includes the bare chamber/end cap volume. End cap volume assumes 12" (300 mm) stone perimeter.

2) Determine the number of chambers (C) required.

To calculate the number of chambers required for adequate storage, divide the storage volume (Vs) by the storage volume of the chamber (from **Table 14**), as follows: **C = Vs / Storage Volume per Chamber**

3) Determine the number of end caps required.

The number of end caps (EC) required depends on the number of rows required by the project. Once the number of chamber rows is determined, multiply the number of chamber rows by 2 to determine the number of end caps required. **EC = No. of Chamber Rows x 2**

NOTE: Additional end caps may be required for systems having inlet locations within the chamber bed.

4) Determine additional storage provided by end caps.

End Caps will provide additional storage to the project. Multiply the number of end caps (EC) by the storage volume per end cap (ECS) to determine the additional storage (As) provided by the end caps. **As = EC x ECS**

5) Adjust number of chambers (C) to account for additional end cap storage (As). The original number of chambers (C) can now be reduced due to the additional storage in the end caps. Divide the additional storage (As) by the storage volume per chamber to determine the number of chambers that can be removed. **Number of chambers to remove = As/ volume per chamber**

NOTE: Additional storage exists in the stone perimeter as well as in the inlet and outlet manifold systems. Contact StormTech’s Technical Services Department for assistance with determining the number of chambers and end caps required for your project.

6) Determine the required bed size (S).

The size of the bed will depend on the number of chambers and end caps required:

MC-4500 area per chamber = 36.6 ft² (3.4 m²)

MC-4500 area per end cap = 23.2 ft² (2.2 m²)

S = (C x area per chamber) + (EC x area per end cap)

NOTE: It is necessary to add 12" (300 mm) of stone perimeter parallel to the chamber rows and 6" (150 mm) of stone perimeter from the base of all end caps. The additional area due to perimeter stone is not included in the area numbers above.

7) Determine the amount of stone (Vst) required.

To calculate the total amount of clean, crushed, angular stone required, multiply the number of chambers (C) and the number of end caps (EC) by the selected weight of stone from **Table 15**.

NOTE: Clean, crushed, angular stone is also required around the perimeter of the system.

TABLE 15—Amount of Stone Per Chamber

ENGLISH tons (yd ³)	Stone Foundation Depth			
	9"	12"	15"	18"
MC-4500	7.4 (5.2)	7.8 (5.5)	8.3 (5.9)	8.8 (6.2)
End Cap	9.6 (6.8)	10.0 (7.1)	10.4 (7.4)	10.9 (7.7)
METRIC kg (m ³)	230 mm	300 mm	375 mm	450 mm
MC-4500	6681 (4.0)	7117 (4.2)	7552 (4.5)	7987 (4.7)
End Cap	8691 (5.2)	9075 (5.4)	9460 (5.6)	9845 (5.9)

NOTE: Assumes 12" (300 mm) of stone above, and 9" (230 mm) row spacing, and 12" (300 mm) of perimeter stone in front of end caps.

8) Determine the volume of excavation (Ex) required.

Each additional foot of cover will add a volume of excavation of 1.4 yd³ (1.0 m³) per MC-4500 chamber and

TABLE 16—Volume of Excavation Per Chamber/End Cap yd³ (m³)

	Stone Foundation Depth			
	9" (230 mm)	12" (300 mm)	15"(375 mm)	18"(450 mm)
MC-4500	10.5 (8.0)	10.8 (8.3)	11.2 (8.5)	11.5 (8.8)
End Cap	9.3 (7.1)	9.6 (7.3)	9.9 (7.6)	10.2 (7.8)

NOTE: Assumes 9" (230 mm) separation between chamber rows, 12" (300 mm) of perimeter in front of end caps, and 24" (600 mm) of cover. The volume of excavation will vary as the depth of cover increases.

1.4 yd³ (0.8 m³) per MC-4500 end cap.

9) Determine the area of geotextile (F) required.

The bottom, top and sides of the bed must be covered with a non-woven geotextile (filter fabric) that meets AASHTO M288 Class 2 requirements. The area of the sidewalls must be calculated and a 24" (600 mm) overlap must be included for all seams. Geotextiles typically come in 15 foot (4.57 m) wide rolls.

7.0 Structural Cross Sections and Specifications

FIGURE 16—MC-3500 Structural Cross Section Detail (Not to Scale)

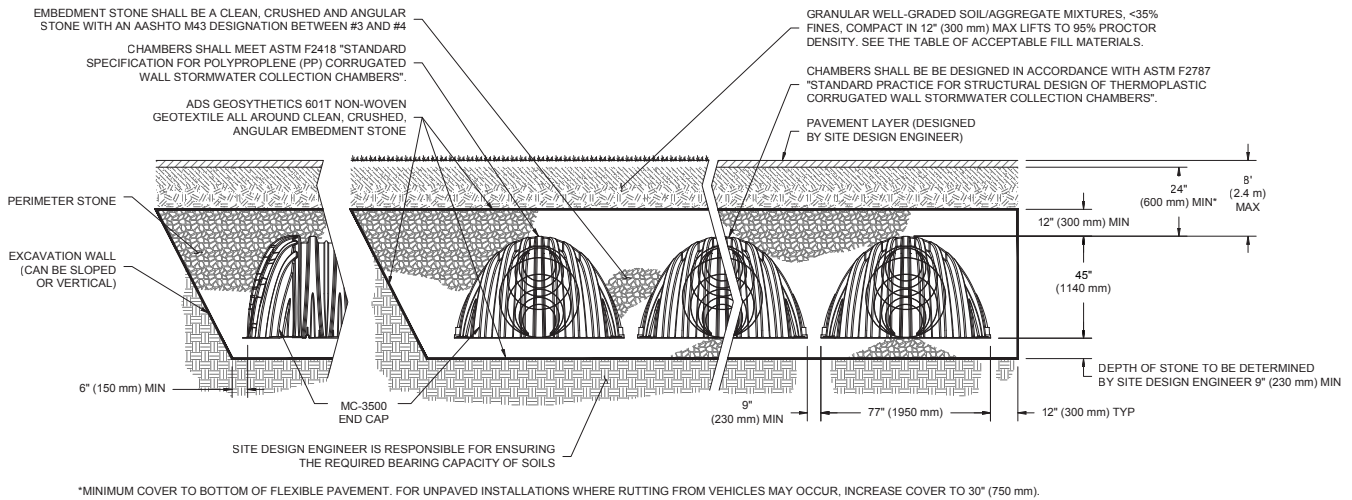

Special applications will be considered on a project by project basis. Please contact our application department should you have a unique application for our team to evaluate.

MC-3500 STORMWATER CHAMBER SPECIFICATIONS

1. Chambers shall be StormTech MC-3500 or approved equal.
2. Chambers shall be made from virgin, impact-modified polypropylene copolymers.
3. Chamber rows shall provide continuous, unobstructed internal space with no internal panels that would impede flow.
4. The structural design of the chambers, the structural backfill and the installation requirements shall ensure that the load factors specified in the AASHTO LRFD Bridge Design Specifications, Section 12.12 are met for: 1) long-duration dead loads and 2) short-duration live loads, based on the AASHTO Design Truck with consideration for impact and multiple vehicle presences.
5. Chambers shall meet the requirements of ASTM F 2418, "Standard Specification for Polypropylene (PP) Corrugated Wall Stormwater Collection Chambers."
6. Chambers shall conform to the requirements of ASTM F 2787, "Standard Practice for Structural Design of Thermoplastic Corrugated Wall Stormwater Collection Chambers."
7. Only chambers that are approved by the engineer will be allowed. The contractor shall submit (3 sets) of the following to the engineer for approval before delivering chambers to the project site:
 - A structural evaluation by a registered structural engineer that demonstrates that the load factors specified in the AASHTO LRFD Bridge Design Specifications, Section 12.12 are met. The 50-year creep modulus data specified in ASTM F 2418 must be used as part of the AASHTO structural evaluation to verify long-term performance.
 - Structural cross section detail on which the structural cross section is based.
8. The installation of chambers shall be in accordance with the manufacturer's latest Construction Guide.

Detail drawings available in Cad Rev. 2000 format at www.stormtech.com

7.0 Structural Cross Sections and Specifications

FIGURE 16—MC-4500 Structural Cross Section Detail (Not to Scale)

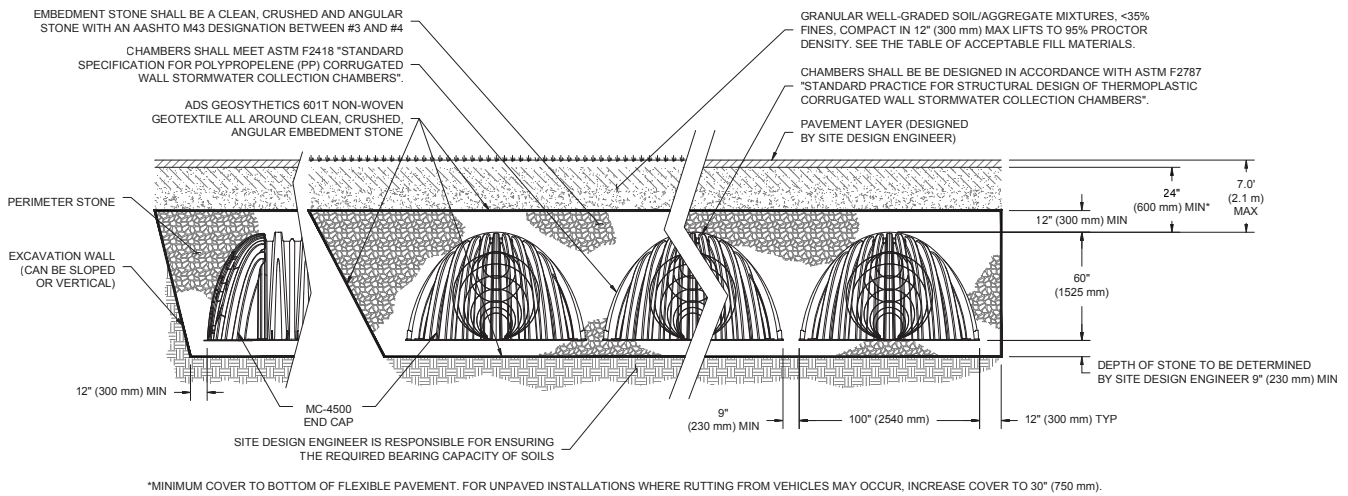

Special applications will be considered on a project by project basis. Please contact our application department should you have a unique application for our team to evaluate.

MC-4500 STORMWATER CHAMBER SPECIFICATIONS

- Chambers shall be StormTech MC-4500 or approved equal.
- Chambers shall be made from virgin, impact-modified polypropylene copolymers.
- Chamber rows shall provide continuous, unobstructed internal space with no internal panels that would impede flow.
- The structural design of the chambers, the structural backfill and the installation requirements shall ensure that the load factors specified in the AASHTO LRFD Bridge Design Specifications, Section 12.12 are met for: 1) long-duration dead loads and 2) short-duration live loads, based on the AASHTO Design Truck with consideration for impact and multiple vehicle presences.
- Chambers shall meet the requirements of ASTM F 2418, "Standard Specification for Polypropylene (PP) Corrugated Wall Stormwater Collection Chambers."
- Chambers shall conform to the requirements of ASTM F 2787, "Standard Practice for Structural Design of Thermoplastic Corrugated Wall Stormwater Collection Chambers."
- Only chambers that are approved by the engineer will be allowed. The contractor shall submit (3 sets) of the following to the engineer for approval before delivering chambers to the project site:
 - A structural evaluation by a registered structural engineer that demonstrates that the load factors specified in the AASHTO LRFD Bridge Design Specifications, Section 12.12 are met. The 50-year creep modulus data specified in ASTM F 2418 must be used as part of the AASHTO structural evaluation to verify long-term performance.
 - Structural cross section detail on which the structural cross section is based.
- The installation of chambers shall be in accordance with the manufacturer's latest Construction Guide.

Detail drawings available in Cad Rev. 2000 format at www.stormtech.com

1. StormTech (“StormTech”) requires installing contractors to use and understand the latest **StormTech MC-3500 and MC-4500 Construction Guide** prior to beginning system installation.
2. StormTech offers installation consultations to installing contractors. Contact our Technical Service Department or local StormTech representative at least 30 days prior to system installation to arrange a pre-installation consultation. Our representatives can then answer questions or address comments on the StormTech chamber system and inform the installing contractor of the minimum installation requirements before beginning the system’s construction. Call 860-529-8188 to speak to a Technical Service Representative or visit www.stormtech.com to receive a copy of our Construction Guide.
3. StormTech requirements for systems with pavement design (asphalt, concrete pavers, etc.): Minimum cover is 24” (600 mm) not including pavement; MC-3500 maximum cover is 8.0’ (1.98 m) and MC-4500 maximum cover is 7.0’ (2.43 m) both including pavement. For designs with cover depths deeper than these maximums, please contact Stormtech. For installations that do not include pavement, where rutting from vehicles may occur, minimum required cover is increased to 30” (762 mm).
4. The contractor must report any discrepancies with the bearing capacity of the subgrade materials to the design engineer.
5. AASHTO M288 Class 2 non-woven geotextile (ADS601 or equal) (filter fabric) must be used as indicated in the project plans.
6. Stone placement between chamber rows and around perimeter must follow instructions as indicated in the most current version of StormTech MC-3500 / MC-4500 Construction Guide.
7. Backfilling over the chambers must follow requirements as indicated in the most current version of StormTech MC-3500 / MC-4500 Construction Guide.
8. The contractor must refer to StormTech MC-3500 / MC-4500 Construction Guide for a Table of Acceptable Vehicle Loads at various depths of cover. This information is also available at the StormTech website: www.stormtech.com. The contractor is responsible for preventing vehicles that exceed StormTech requirements from traveling across or parking over the stormwater system. Temporary fencing, warning tape and appropriately located signs are commonly used to prevent unauthorized vehicles from entering sensitive construction areas.
9. The contractor must apply erosion and sediment control measures to protect the stormwater system during all phases of site construction per local codes and design engineer’s specifications.
10. STORMTECH PRODUCT WARRANTY IS LIMITED. Contact StormTech for warranty information.

9.1 ISOLATOR ROW INSPECTION

Regular inspection and maintenance are essential to assure a properly functioning stormwater system. Inspection is easily accomplished through the manhole or optional inspection ports of an Isolator Row. Please follow local and OSHA rules for a confined space entry.

Inspection ports can allow inspection to be accomplished completely from the surface without the need for a confined space entry. Inspection ports provide visual access to the system with the use of a flashlight. A stadia rod may be inserted to determine the depth of sediment. If upon visual inspection it is found that sediment has accumulated to an average depth exceeding 3" (76 mm), cleanout is required.

A StormTech Isolator Row should initially be inspected immediately after completion of the site's construction. While every effort should be made to prevent sediment from entering the system during construction, it is during this time that excess amounts of sediments are most likely to enter any stormwater system. Inspection and maintenance, if necessary, should be performed prior to passing responsibility over to the site's owner. Once in normal service, a StormTech Isolator Row should be inspected bi-annually until an understanding of the sites characteristics is developed. The site's maintenance manager can then revise the inspection schedule based on experience or local requirements.

9.2 ISOLATOR ROW MAINTENANCE

JetVac maintenance is recommended if sediment has been collected to an average depth of 3" (76 mm) inside the Isolator Row. More frequent maintenance may be required to maintain minimum flow rates through the Isolator Row. The JetVac process utilizes a high pressure water nozzle to propel itself down the Isolator Row while scouring and suspending sediments. As the nozzle is retrieved, a wave of suspended sediments is flushed back into the manhole for vacuuming. Most sewer and pipe maintenance companies have vacuum/ JetVac combination vehicles. Fixed nozzles designed for culverts or large diameter pipe cleaning are preferable. Rear facing jets with an effective spread of at least 45" (1143 mm) are best. The JetVac process shall only be performed on StormTech Rows that have AASHTO class 1 woven geotextile over their foundation stone (ADS 315WTM or equal).



Looking down the Isolator Row



A typical JetVac truck (This is not a StormTech product.)



Examples of culvert cleaning nozzles appropriate for Isolator Row maintenance. (These are not StormTech products).



A Family of Products and Services for the Stormwater Industry:

- MC-3500 and MC-4500 Chambers and End Caps
- SC-310 and SC-740 Chambers and End Caps
- DC-780 Chambers and End Caps
- Fabricated End Caps
- Fabricated Manifold Fittings
- Patented Isolator Row for Maintenance and Water Quality
- Chamber Separation Spacers
- In-House System Layout Assistance
- On-Site Educational Seminars
- Worldwide Technical Sales Group
- Centralized Product Applications Department
- Research and Development Team
- Technical Literature, O&M Manuals and Detailed CAD drawings all downloadable via our Website

StormTech provides state-of-the-art products and services that meet or exceed industry performance standards and expectations. We offer designers, regulators, owners and contractors the highest quality products and services for stormwater management that "Saves Valuable Land and Protects Water Resources."



Advanced Drainage Systems, Inc.
4640 Trueman Blvd. Hilliard, OH 43026

1-800-821-6710

www.ads-pipe.com



Modular Wetlands[®] System Linear

A Stormwater Biofiltration Solution



OVERVIEW

The Bio Clean Modular Wetlands® System Linear (MWS Linear) represents a pioneering breakthrough in stormwater technology as the only biofiltration system to utilize patented horizontal flow, allowing for a smaller footprint, higher treatment capacity, and a wide range of versatility. While most biofilters use little or no pretreatment, the Modular Wetlands System Linear incorporates an advanced pretreatment chamber that includes separation and pre-filter cartridges. In this chamber, sediment and hydrocarbons are removed from runoff before entering the biofiltration chamber, reducing maintenance costs and improving performance.

Horizontal flow also gives the system the unique ability to adapt to the environment through a variety of configurations, bypass orientations, and diversion applications.

The Urban Impact

For hundreds of years, natural wetlands surrounding our shores have played an integral role as nature's stormwater treatment system. But as cities grow and develop, our environment's natural filtration systems are blanketed with impervious roads, rooftops, and parking lots.

Bio Clean understands this loss and has spent years re-establishing nature's presence in urban areas, and rejuvenating waterways with the MWS Linear.

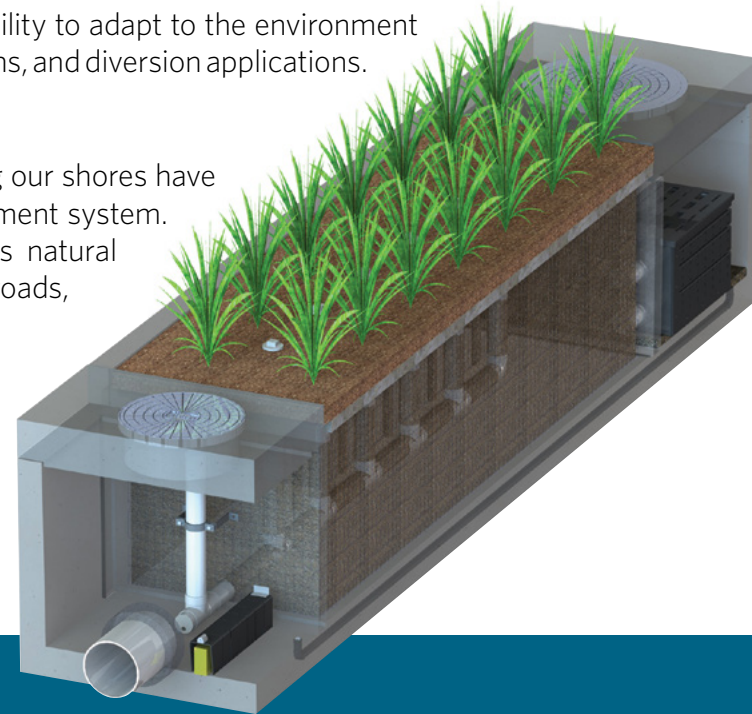

PERFORMANCE

The Modular Wetlands® System Linear continues to outperform other treatment methods with superior pollutant removal for TSS, heavy metals, nutrients, hydrocarbons, and bacteria. Since 2007 the MWS Linear has been field tested on numerous sites across the country and is proven to effectively remove pollutants through a combination of physical, chemical, and biological filtration processes. In fact, the MWS Linear harnesses some of the same biological processes found in natural wetlands in order to collect, transform, and remove even the most harmful pollutants.

66% REMOVAL OF DISSOLVED ZINC	69% REMOVAL OF TOTAL ZINC	38% REMOVAL OF DISSOLVED COPPER	64% REMOVAL OF TOTAL PHOSPHORUS	
45% REMOVAL OF NITROGEN	50% REMOVAL OF TOTAL COPPER	95% REMOVAL OF MOTOR OIL	67% REMOVAL OF ORTHO PHOSPHORUS	85% REMOVAL OF TSS

APPROVALS

The Modular Wetlands® System Linear has successfully met years of challenging technical reviews and testing from some of the most prestigious and demanding agencies in the nation and perhaps the world. Here is a list of some of the most high-profile approvals, certifications, and verifications from around the country.



Washington State Department of Ecology TAPe Approved

The MWS Linear is approved for General Use Level Designation (GULD) for Basic, Enhanced, and Phosphorus treatment at 1 gpm/ft² loading rate. The highest performing BMP on the market for all main pollutant categories.



California Water Resources Control Board, Full Capture Certification

The Modular Wetlands® System is the first biofiltration system to receive certification as a full capture trash treatment control device.



Virginia Department of Environmental Quality, Assignment

The Virginia Department of Environmental Quality assigned the MWS Linear the highest phosphorus removal rating for manufactured treatment devices to meet the new Virginia Stormwater Management Program (VSMP) regulation technical criteria.



Maryland Department of the Environment, Approved ESD

Granted Environmental Site Design (ESD) status for new construction, redevelopment, and retrofitting when designed in accordance with the design manual.



MASTEP Evaluation

The University of Massachusetts at Amherst - Water Resources Research Center issued a technical evaluation report noting removal rates up to 84% TSS, 70% total phosphorus, 68.5% total zinc, and more.



Rhode Island Department of Environmental Management, Approved BMP

Approved as an authorized BMP and noted to achieve the following minimum removal efficiencies: 85% TSS, 60% pathogens, 30% total phosphorus, and 30% total nitrogen.



Texas Commission on Environmental Quality



Atlanta Regional Commission

ADVANTAGES

- HORIZONTAL FLOW BIOFILTRATION
- GREATER FILTER SURFACE AREA
- PRETREATMENT CHAMBER
- PATENTED PERIMETER VOID AREA
- FLOW CONTROL
- NO DEPRESSED PLANTER AREA
- AUTO DRAINDOWN MEANS NO MOSQUITO VECTOR

OPERATION

The Modular Wetlands® System Linear is the most efficient and versatile biofiltration system on the market, and it is the only system with horizontal flow which:

- Improves performance
- Reduces footprint
- Minimizes maintenance

Figure 1 & Figure 2 illustrate the invaluable benefits of horizontal flow and the multiple treatment stages.

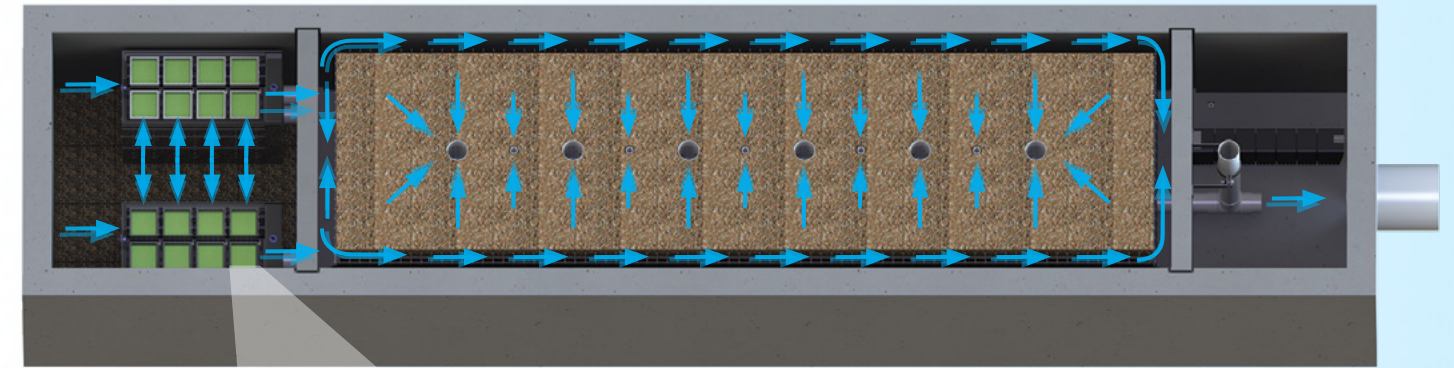

Figure 2,
Top View

2x to 3x more surface area than traditional downward flow bioretention systems.

1 PRETREATMENT

SEPARATION

- Trash, sediment, and debris are separated before entering the pre-filter boxes
- Designed for easy maintenance access

PRE-FILTER BOXES

- Over 25 sq. ft. of surface area per box
- Utilizes BioMediaGREEN™ filter material
- Removes over 80% of TSS and 90% of hydrocarbons
- Prevents pollutants that cause clogging from migrating to the biofiltration chamber

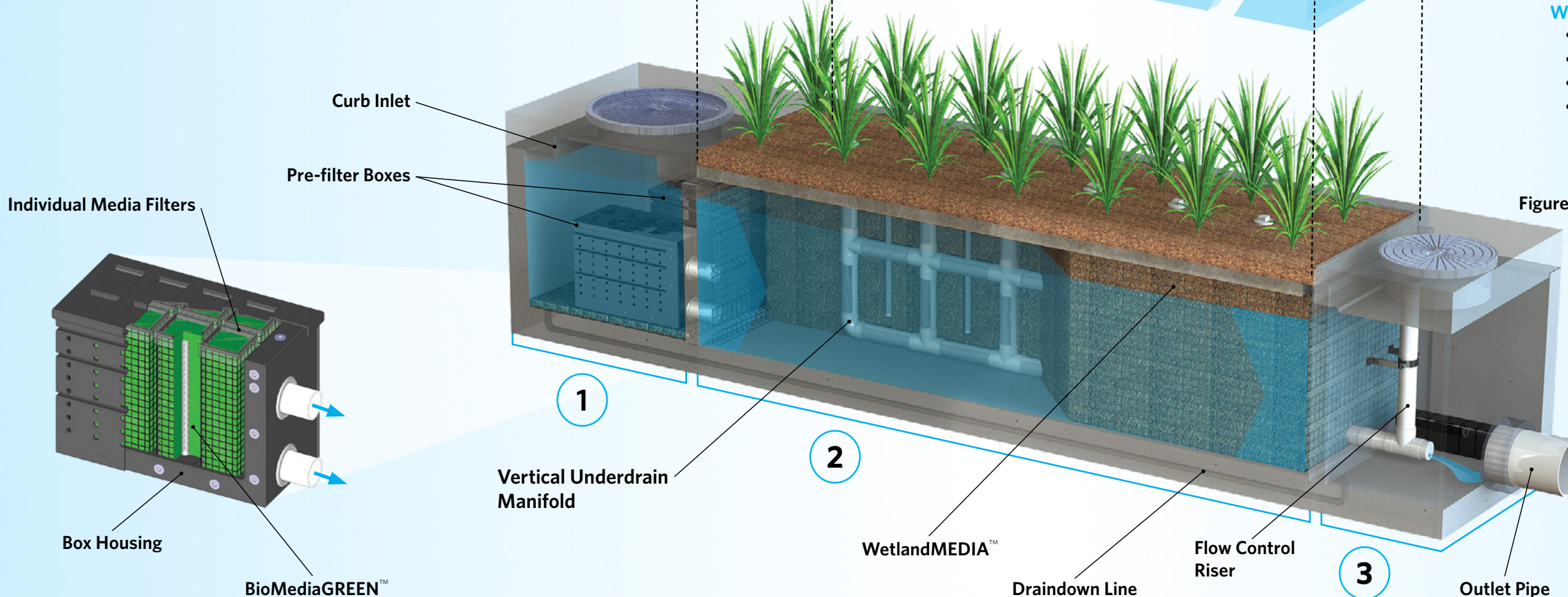

Figure 1

2 BIOFILTRATION

HORIZONTAL FLOW

- Less clogging than downward flow biofilters
- Water flow is subsurface
- Improves biological filtration

PATENTED PERIMETER VOID AREA

- Vertically extends void area between the walls and the WetlandMEDIA™ on all four sides
- Maximizes surface area of the media for higher treatment capacity

WETLANDMEDIA

- Contains no organics and removes phosphorus
- Greater surface area and 48% void space
- Maximum evapotranspiration
- High ion exchange capacity and lightweight

3 DISCHARGE

FLOW CONTROL

- Orifice plate controls flow of water through WetlandMEDIA™ to a level lower than the media's capacity
- Extends the life of the media and improves performance

DRAINDOWN FILTER

- The draindown is an optional feature that completely drains the pretreatment chamber
- Water that drains from the pretreatment chamber between storm events will be treated



CONFIGURATIONS

The Modular Wetlands® System Linear is the preferred biofiltration system of civil engineers across the country due to its versatile design. This highly versatile system has available “pipe-in” options on most models, along with built-in curb or grated inlets for simple integration into your storm drain design.

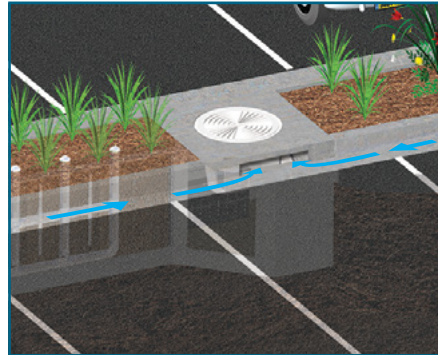

CURB TYPE

The Curb Type configuration accepts sheet flow through a curb opening and is commonly used along roadways and parking lots. It can be used in sump or flow-by conditions. Length of curb opening varies based on model and size.

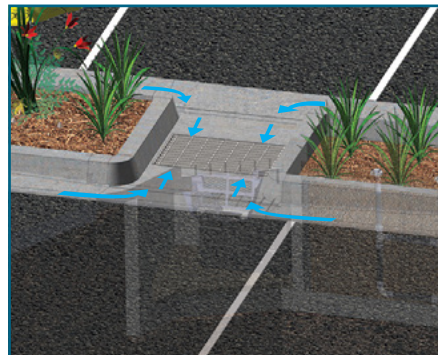

GRATE TYPE

The Grate Type configuration offers the same features and benefits as the Curb Type but with a grated/drop inlet above the systems pretreatment chamber. It has the added benefit of allowing pedestrian access over the inlet. ADA-compliant grates are available to assure easy and safe access. The Grate Type can also be used in scenarios where runoff needs to be intercepted on both sides of landscape islands.

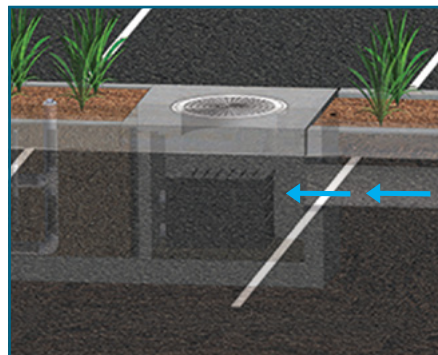

VAULT TYPE

The system’s patented horizontal flow biofilter is able to accept inflow pipes directly into the pretreatment chamber, meaning the Modular Wetlands® can be used in end-of-the-line installations. This greatly improves feasibility over typical decentralized designs that are required with other biofiltration/bioretenion systems. Another benefit of the “pipe-in” design is the ability to install the system downstream of underground detention systems to meet water quality volume requirements.



DOWNSPOUT TYPE

The Downspout Type is a variation of the Vault Type and is designed to accept a vertical downspout pipe from rooftop and podium areas. Some models have the option of utilizing an internal bypass, simplifying the overall design. The system can be installed as a raised planter, and the exterior can be stuccoed or covered with other finishes to match the look of adjacent buildings.

ORIENTATIONS

SIDE-BY-SIDE

The Side-By-Side orientation places the pretreatment and discharge chamber adjacent to one another with the biofiltration chamber running parallel on either side. This minimizes the system length, providing a highly compact footprint. It has been proven useful in situations such as streets with directly adjacent sidewalks, as half of the system can be placed under that sidewalk. This orientation also offers internal bypass options as discussed below.

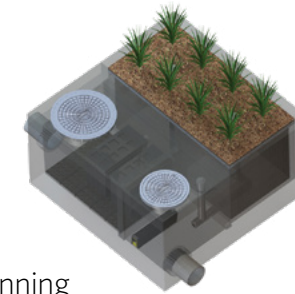

END-TO-END

The End-To-End orientation places the pretreatment and discharge chambers on opposite ends of the biofiltration chamber, therefore minimizing the width of the system to 5 ft. (outside dimension). This orientation is perfect for linear projects and street retrofits where existing utilities and sidewalks limit the amount of space available for installation. One limitation of this orientation is that bypass must be external.

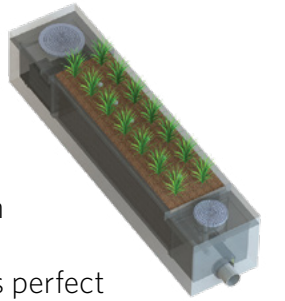

BYPASS

INTERNAL BYPASS WEIR (SIDE-BY-SIDE ONLY)

The Side-By-Side orientation places the pretreatment and discharge chambers adjacent to one another allowing for integration of internal bypass. The wall between these chambers can act as a bypass weir when flows exceed the system’s treatment capacity, thus allowing bypass from the pretreatment chamber directly to the discharge chamber.

EXTERNAL DIVERSION WEIR STRUCTURE

This traditional offline diversion method can be used with the Modular Wetlands® System Linear in scenarios where runoff is being piped to the system. These simple and effective structures are generally configured with two outflow pipes. The first is a smaller pipe on the upstream side of the diversion weir - to divert low flows over to the MWS Linear for treatment. The second is the main pipe that receives water once the system has exceeded treatment capacity and water flows over the weir.

FLOW-BY-DESIGN

This method is one in which the system is placed just upstream of a standard curb or grate inlet to intercept the first flush. Higher flows simply pass by the MWS Linear and into the standard inlet downstream.

DVERT LOW FLOW DIVERSION

This simple yet innovative diversion trough can be installed in existing or new curb and grate inlets to divert the first flush to the Modular Wetlands® System Linear via pipe. It works similar to a rain gutter and is installed just below the opening into the inlet. It captures the low flows and channels

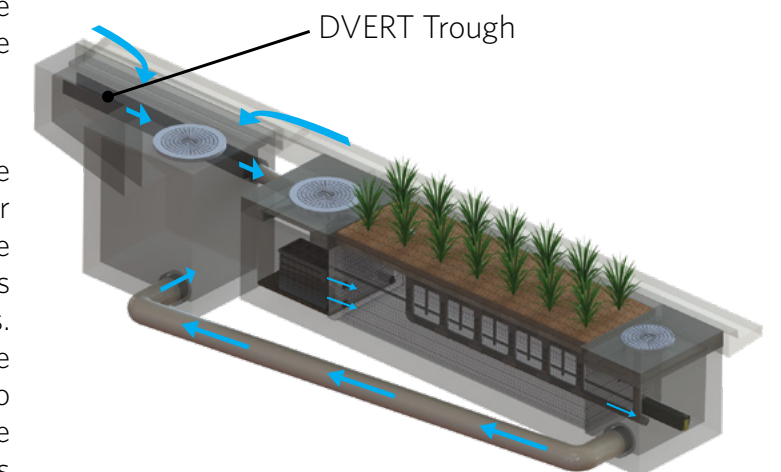

them over to a connecting pipe exiting out the wall of the inlet and leading to the MWS Linear. The DVERT is perfect for retrofit and green street applications that allow the system to be installed anywhere space is available.

SPECIFICATIONS

FLOW-BASED DESIGNS

The Modular Wetlands® System Linear can be used in stand-alone applications to meet treatment flow requirements, and since it is the only biofiltration system that can accept inflow pipes several feet below the surface, it can be used not only in decentralized design applications but also as a large central end-of-the-line application for maximum feasibility.

MODEL #	DIMENSIONS	WETLAND MEDIA SURFACE AREA (sq. ft.)	TREATMENT FLOW RATE (cfs)
MWS-L-4-4	4' x 4'	23	0.052
MWS-L-4-6	4' x 6'	32	0.073
MWS-L-4-8	4' x 8'	50	0.115
MWS-L-4-13	4' x 13'	63	0.144
MWS-L-4-15	4' x 15'	76	0.175
MWS-L-4-17	4' x 17'	90	0.206
MWS-L-4-19	4' x 19'	103	0.237
MWS-L-4-21	4' x 21'	117	0.268
MWS-L-6-8	7' x 9'	64	0.147
MWS-L-8-8	8' x 8'	100	0.230
MWS-L-8-12	8' x 12'	151	0.346
MWS-L-8-16	8' x 16'	201	0.462
MWS-L-8-20	9' x 21'	252	0.577
MWS-L-8-24	9' x 25'	302	0.693
MWS-L-10-20	10' x 20'	302	0.693

VOLUME-BASED DESIGNS

HORIZONTAL FLOW BIOFILTRATION ADVANTAGE



MODULAR WETLANDS® SYSTEM LINEAR WITH URBANPOND™ PRESTORAGE

In the example above, the Modular Wetlands® System Linear is installed downstream of the UrbanPond storage system. The MWS Linear is designed for the water quality volume and will treat and discharge the required volume within local draindown time requirements. The MWS Linear's unique horizontal flow design, gives it benefits no other biofilter has - the ability to be placed downstream of detention ponds, extended dry detention basins, underground storage systems and permeable paver reservoirs. The system's horizontal flow configuration and built-in orifice control allows it to be installed with just 6" of fall between inlet and outlet pipe for a simple connection to projects with shallow downstream tie-in points.

UrbanPond
Single and Double Modules

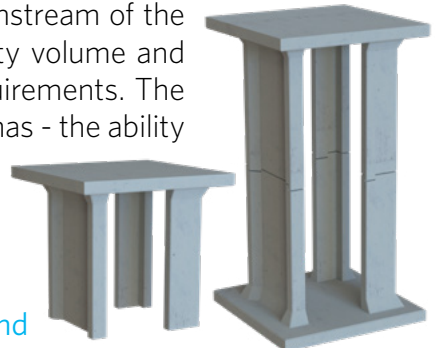

DESIGN SUPPORT

Bio Clean engineers are trained to provide you with superior support for all volume sizing configurations throughout the country. Our vast knowledge of state and local regulations allow us to quickly and efficiently size a system to maximize feasibility. Volume control and hydromodification regulations are expanding the need to decrease the cost and size of your biofiltration system. Bio Clean will help you realize these cost savings with the MWS Linear, the only biofilter than can be used downstream of storage BMPs.

ADVANTAGES

- LOWER COST THAN FLOW-BASED DESIGN
- BUILT-IN ORIFICE CONTROL STRUCTURE
- MEETS LID REQUIREMENTS
- WORKS WITH DEEP INSTALLATIONS

APPLICATIONS

The Modular Wetlands® System Linear has been successfully used on numerous new construction and retrofit projects. The system's superior versatility makes it beneficial for a wide range of stormwater and waste water applications - treating rooftops, streetscapes, parking lots, and industrial sites.



INDUSTRIAL

Many states enforce strict regulations for discharges from industrial sites. The MWS Linear has helped various sites meet difficult EPA-mandated effluent limits for dissolved metals and other pollutants.



RESIDENTIAL

Low to high density developments can benefit from the versatile design of the MWS Linear. The system can be used in both decentralized LID design and cost-effective end-of-the-line configurations.

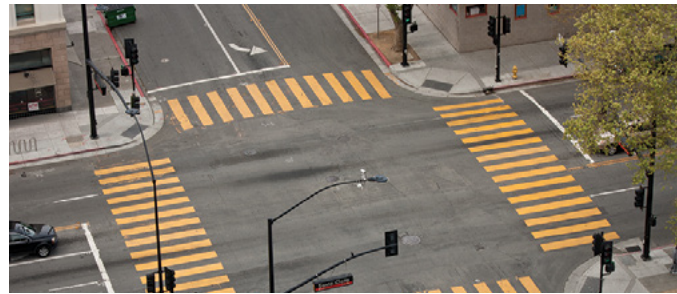

STREETS

Street applications can be challenging due to limited space. The MWS Linear is very adaptable, and it offers the smallest footprint to work around the constraints of existing utilities on retrofit projects.



PARKING LOTS

Parking lots are designed to maximize space and the Modular Wetlands® 4 ft. standard planter width allows for easy integration into parking lot islands and other landscape medians.



COMMERCIAL

Compared to bioretention systems, the MWS Linear can treat far more area in less space, meeting treatment and volume control requirements.



MIXED USE

The MWS Linear can be installed as a raised planter to treat runoff from rooftops or patios, making it perfect for sustainable "live-work" spaces.

More applications include:

- Agriculture
- Reuse
- Low Impact Development
- Waste Water

PLANT SELECTION

Abundant plants, trees, and grasses bring value and an aesthetic benefit to any urban setting, but those in the Modular Wetlands® System Linear do even more - they increase pollutant removal. What's not seen, but very important, is that below grade, the stormwater runoff/flow is being subjected to nature's secret weapon: a dynamic physical, chemical, and biological process working to break down and remove non-point source pollutants. The flow rate is controlled in the MWS Linear, giving the plants more contact time so that pollutants are more successfully decomposed, volatilized, and incorporated into the biomass of the Modular Wetlands® micro/macro flora and fauna.



A wide range of plants are suitable for use in the Modular Wetlands®, but selections vary by location and climate. View suitable plants by visiting biocleanenvironmental.com/plants.

INSTALLATION



The Modular Wetlands® System Linear is simple, easy to install, and has a space-efficient design that offers lower excavation and installation costs compared to traditional tree-box type systems. The structure of the system resembles precast catch basin or utility vaults and is installed in a similar fashion.

The system is delivered fully assembled for quick installation. Generally, the structure can be unloaded and set in place in 15 minutes. Our experienced team of field technicians is available to supervise installations and provide technical support.

MAINTENANCE



Reduce your maintenance costs, man hours, and materials with the Modular Wetlands® System Linear. Unlike other biofiltration systems that provide no pretreatment, the MWS Linear is a self-contained treatment train which incorporates simple and effective pretreatment.

Maintenance requirements for the biofilter itself are almost completely eliminated, as the pretreatment chamber removes and isolates trash, sediments, and hydrocarbons. What's left is the simple maintenance of an easily accessible pretreatment chamber that can be cleaned by hand or with a standard vac truck. Only periodic replacement of low-cost media in the pre-filter boxes is required for long-term operation, and there is absolutely no need to replace expensive biofiltration media.



Bio  Clean
A Forterra Company

5796 Armada Drive Suite 250
Carlsbad, CA 92008
855.566.3938
stormwater@forterrabp.com
biocleanenvironmental.com